

HYDRAULICS AND FIELD PERFORMANCE OF A NOVEL MICRO SPRINKLER

By
SOUMYA RANI, T
(2010 - 18 - 106)



DEPARTMENT OF LAND & WATER RESOURCES AND CONSERVATION ENGINEERING
KELAPPAJI COLLEGE OF AGRICULTURAL ENGINEERING AND TECHNOLOGY
TAVANUR - 679573, MALAPPURAM

2012

HYDRAULICS AND FIELD PERFORMANCE OF A NOVEL MICRO SPRINKLER

By

SOUMYA RANI, T

(2010 - 18 - 106)

THESIS

**Submitted in partial fulfilment of the
requirement for the degree of**

MASTER OF TECHNOLOGY

IN

AGRICULTURAL ENGINEERING

(Soil and Water Engineering)

Faculty of Agricultural Engineering & Technology

Kerala Agricultural University



DEPARTMENT OF LAND & WATER RESOURCES AND CONSERVATION ENGINEERING

KELAPPAJI COLLEGE OF AGRICULTURAL ENGINEERING AND TECHNOLOGY

TAVANUR - 679573, MALAPPURAM

2012

DECLARATION

I hereby declare that this thesis entitled “**Hydraulics and field performance of a novel micro sprinkler**” is a bonafide record of research done by me during the course of research and that the thesis has not previously formed the basis for the award of any degree, diploma, fellowship or other similar title, of any other University or Society.

Tavanur

Date:

Soumya Rani T

(2010 - 18 - 106)

Dr. Sathian, K.K

Associate Professor

Department of Land & Water Resources and Conservation Engineering

KCAET, Kerala agricultural University

Tavanur, Malappuram, Kerala

Date:

CERTIFICATE

Certified that this thesis, entitled “**Hydraulics and field performance of a novel micro sprinkler**” is a record of research work done independently by **Ms. Soumya Rani T (2010- 18- 106)** under my guidance and supervision and that it has not previously formed the basis for the award of any degree, diploma, fellowship or associateship to her.

Tavanur

Dr. Sathian, K.K
Chairman
Advisory Committee

CERTIFICATE

We, the undersigned, members of the advisory committee of **Ms. Soumya Rani T (2010-18-106)** a candidate for the degree of **Master of Technology in Agricultural Engineering** agree that the thesis entitled **“Hydraulics and field performance of a novel micro sprinkler”** may be submitted by **Ms. Soumya Rani T (2010-18-106)**, in partial fulfillment of the requirement for the degree.

Dr. Sathian, K.K
Associate Professor
Department of LWRCE
KCAET, Tavanur
(Chairman)

Dr. Habeeburrahman, P. V
Professor and Head
KVK, Malappuram
(Member)

Dr. Kurien, E.K
Associate Professor and Head
Department of LWRCE
KCAET, Tavanur.
(Member)

Dr. Rema. K.P
Associate Professor
Department of IDE
KCAET, Tavanur
(Member)

ACKNOWLEDGEMENT

ACKNOWLEDGEMENT

*It is a matter of profound privilege to give sincere thanks to **Dr. Sathian, K.K.**, Associate Professor, Dept. of LWRCE, KCAET, Tavanur for his valuable guidance, encouragement and immense help throughout the course of work.*

*I would like to express my sincere thanks to **Dr. Sivaswami, M.**, Dean, KCAET, Tavanur, for his interest and kind advice given to me at all stages of my study.*

*It is my privilege to acknowledge the sincere help and proper suggestions from **Dr. Habeeburrahman, P.V.**, Head, KVK, Malappuram, **Dr. Kurien, E.K.**, Associate Professor and Head, Dept. of LWRCE, KCAET, Tavanur, and **Dr. Rema, K.P.**, Associate Professor, Dept. of IDE, as a member of my advisory committee.*

*I take this opportunity to express my sincere gratitude and heartfelt thanks to **Er. Asha Joseph**, Associate Professor, Dept. of IDE, KCAET, Tavanur, for her sustained interest, advices and moral support extended to me to complete this research work.*

*I remember with thanks to **Dr. Krishan, S.**, Associate Professor and Head, Dept. of Statistics, College of Horticulture, Vellanikkara and **Dr. Sarah T George**, Professor, KVK, Malappuram for the concern and consideration they have shown all through this research.*

*I am immensely thankful to **Er. Anu Varghese**, Assistant Professor, Dept. of IDE, KCAET, Tavanur for giving valuable suggestions and constant backing at all stages of this research work.*

*I consider it as a pleasure to express my profound gratitude to **Er. Priya G Nair**, Assistant Professor, Dept. of LWRCE, KCAET, Tavanur, for her sincere help and co-operation extended towards me for the completion of this work.*

*I am highly thankful to **Dr. Berin Pathrose**, Assistant Professor, KVK, Malappuram and **Dr. Jalaja S Menon**, Assistant Professor, KVK, Thrissur, for their valuable advices throughout my research work.*

*It is my greatest privilege to acknowledge the valuable help rendered to me by **Er. Sreekesh, S.**, Teaching Assistant and **Haris, P**, SA, RKVY, KCAET, Tavanur.*

*My heartfelt gratitude to **Mr. Anil**, **Mr. Sajith** and all other workshop technicians for their timely help and support.*

*I have immense pleasure to express my deep sense of gratitude to my friend **Er. Nadiya Nesthad** for her continuous help and co-operation rendered to me to complete my thesis work. My sincere thanks are extended to my friends at KCAET for their remarkable co-operation and encouragement to me during the tenure.*

*I express my whole hearted thanks to **Shri. Avaran, M**, a farmer from malappuram district and all the farm labourers especially **Vasudevan**, **Karthyayani**, **Sujatha and Sasi** for their timely help and support rendered to this work.*

I am thankful to Research Assistants, Skilled Assistants and all the workers of KVK, Malappuram for their catalytic comments and creative suggestions.

I express my deep sense of gratitude to my loving parents and family members for their continuous support and inspiration all through my studies.

Above all, I bow my head before the Almighty for his blessings and procurement which empowered me to complete this work.

Soumya Rani, T

Dedicated to
My loving family

CONTENTS

Chapter No.	Title	Page No.
	LIST OF TABLES	viii
	LIST OF FIGURES	ix
	LIST OF PLATES	xiii
	SYMBOLS AND ABBREVIATIONS	xiv
1	INTRODUCTION	1
2	REVIEW OF LITERATURE	6
3	MATERIALS AND METHODS	34
4	RESULTS AND DISCUSSION	48
5	SUMMARY AND CONCLUSION	90
	REFERENCES	
	APPENDICES	
	ABSTRACT	

LIST OF TABLES

Table No.	Title	Page No.
4.1	Coefficient of uniformity of FDMS at various operating pressures	62
4.2	Coefficient of variation of FDMS at various operating pressures	62
4.3	Distribution characteristic of FDMS at various operating pressures	63
4.4	Possible discharge of standardised micro sprinkler	63
4.5	Effect of micro sprinkler on moisture distribution at the soil surface	82
4.6	Effect of micro sprinkler on moisture distribution at 30 cm depth from the soil surface	82
4.7	Data on growth and yield of cucumber	84

LIST OF FIGURES

Figure No.	Title	Page No.
3.1	Placement of catch-cans over the grid	38
3.2	Layout of the field experiment	43
3.3	Moisture content determination	46
4.1	Mean discharge of the FDMS at various operating pressures	49
4.2	Discharge of FDMS at 0.5 kg/cm ²	50
4.3	Discharge of FDMS at 1.0 kg/cm ²	50
4.4	Discharge of FDMS at 1.5 kg/cm ²	50
4.5	Discharge of FDMS at 2.0 kg/cm ²	50
4.6	Mean wetted radius of FDMS at various operating pressures	51
4.7	Wetted radius of FDMS at 0.5 kg/cm ²	52
4.8	Wetted radius of FDMS at 1.0 kg/cm ²	52
4.9	Wetted radius of FDMS at 1.5 kg/cm ²	52
4.10	Wetted radius of FDMS at 2.0 kg/cm ²	52
4.11	Mean application depth of FDMS at various operating pressures	53
4.12	Mean application depth of FDMS at 0.5 kg/cm ²	54
4.13	Mean application depth of FDMS at 1.0 kg/cm ²	54
4.14	Mean application depth of FDMS at 1.5 kg/cm ²	54
4.15	Mean application depth of FDMS at 2.0 kg/cm ²	54
4.16	Water distribution pattern of 0.5 mm wide cut FDMS at 0.5 kg/cm ²	56

Figure No.	Title	Page No.
4.17	Water distribution pattern of 0.5 mm wide cut FDMS at 1.0 kg/cm ²	56
4.18	Water distribution pattern of 0.5 mm wide cut FDMS at 1.5 kg/cm ²	56
4.19	Water distribution pattern of 0.5 mm wide cut FDMS at 2.0 kg/cm ²	56
4.20	Water distribution pattern of 1.0 mm wide cut FDMS at 0.5 kg/cm ²	57
4.21	Water distribution pattern of 1.0 mm wide cut FDMS at 1.0 kg/cm ²	57
4.22	Water distribution pattern of 1.0 mm wide cut FDMS at 1.5 kg/cm ²	57
4.23	Water distribution pattern of 1.0 mm wide cut FDMS at 2.0 kg/cm ²	57
4.24	Water distribution pattern of 1.5 mm wide cut FDMS at 0.5 kg/cm ²	58
4.25	water distribution pattern of 1.5 mm wide cut FDMS at 1.0 kg/cm ²	58
4.26	Water distribution pattern of 1.5 mm wide cut FDMS at 1.5 kg/cm ²	58
4.27	Water distribution pattern of 1.5 mm wide cut FDMS at 2.0 kg/cm ²	58
4.28	Water distribution pattern of 2.0 mm wide cut FDMS at 0.5 kg/cm ²	59
4.29	Water distribution pattern of 2.0 mm wide cut FDMS at 1.0 kg/cm ²	59
4.30	Water distribution pattern of 2.0 mm wide cut FDMS at 1.5 kg/cm ²	59
4.31	Water distribution pattern of 2.0 mm wide cut FDMS at 2.0 kg/cm ²	59
4.32	Design drawing of the micro sprinkler sample to be moulded	65
4.33	Mean discharge of FMMS at various operating pressures	66
4.34	Discharge of FMMS at 0.5 kg/cm ²	67
4.35	Discharge of FMMS at 1.0 kg/cm ²	67

4.36	Discharge of FMMS at 1.5 kg/cm ²	67
4.37	Discharge of FMMS at 2.0 kg/cm ²	67
4.38	Mean wetted radius of FMMS at various operating pressures	69
4.39	Wetted radius of FMMS at 0.5 kg/cm ²	70
4.40	Wetted radius of FMMS at 1.0 kg/cm ²	70
4.41	Wetted radius of FMMS at 1.5 kg/cm ²	70
4.42	Wetted radius of FMMS at 2.0 kg/cm ²	70
4.43	Mean application depth of FMMS at various operating pressures	71
4.44	Mean application depth of FMMS at 0.5 kg/cm ²	72
4.45	Mean application depth of FMMS at 1.0 kg/cm ²	72
4.46	Mean application depth of FMMS at 1.5 kg/cm ²	72
4.47	Mean application depth of FMMS at 2.0 kg/cm ²	72
4.48	Mean discharge of SMMS at various operating pressures	75
4.49	Discharge of SMMS at 0.5 kg/cm ²	76
4.50	Discharge of SMMS at 1.0 kg/cm ²	76
4.51	Discharge of SMMS at 1.5 kg/cm ²	76
4.52	Discharge of SMMS at 2.0 kg/cm ²	76
4.53	Mean wetted radius of SMMS at various operating pressures	77
4.54	Wetted radius of SMMS at 0.5 kg/cm ²	78
4.55	Wetted radius of SMMS at 1.0 kg/cm ²	78
4.56	Wetted radius of SMMS at 1.5 kg/cm ²	78
4.57	Wetted radius of SMMS at 2.0 kg/cm ²	78

4.58	Mean application depth of SMMS at various operating pressures	79
4.59	Mean application depth of SMMS at 0.5 kg/cm ²	80
4.60	Mean application depth of SMMS at 1.0 kg/cm ²	80
4.61	Mean application depth of SMMS at 1.5 kg/cm ²	80
4.62	Mean application depth of SMMS at 2.0 kg/cm ²	80
4.63	Effect of micro sprinkler treatments on soil temperature in the field	83
4.64	Effect of micro sprinkler treatments on number of female flowers per plant	84
4.65	Effect of micro sprinkler treatments on yield of Cucumber	86
4.66	Effect of micro sprinkler treatments on number of fruits per plant	87
4.67	Effect of micro sprinkler treatments on fruit length	87
4.68	Effect of micro sprinkler treatments on fruit girth	87
4.69	Effect of micro sprinkler treatments on water use efficiency	88

LIST OF PLATES

Plate No.	Title	Page No.
3.1	Micro sprinkler developed by farmer	35
3.2	Discharge measurement	37
3.3	Pressure gauge	37
3.4	Test set up- pump, pipe and control valves	37
3.5	Micro sprinkler with lateral	39
3.6	Uniformity test using catch-cans	39
4.1	Mould developed for plastic injection moulding	65
4.2	First moulded micro sprinkler	66
4.3	Second moulded micro sprinkler	75
4.4	Micro sprinkler in field	85
4.5	A view of harvested cucumber	85

SYMBOLS AND ABBREVIATIONS

Agric.	Agricultural
ASABE	American Society of Agricultural and Biological Engineers
BIS	Bureau of Indian Standards
CD	Critical difference
cm	Centimeter(s)
cm ²	Square centimeter(s)
CPE	Cummulative pan evaporation
COV	Coefficient of variation
CUC	Christiansen's uniformity coefficient
D _a	Mean application depth
DC	Distribution characteristic
DF	Degrees of freedom
Dept.	Department
Engng	Engineering
E _p	Normal monthly pan evaporation
ET	Evapotranspiration
et. al.	and others
Fig.	Figure
FDMS	Farmer developed micro sprinkler
FMMS	First moulded micro sprinkler
GSM	Gram per square meter(s)

ha	Hectare
HDPE	High Density Poly Ethylene
hp	Horse power
h	Hour(s)
IW/CPE	Irrigation water requirement/Cummulative pan evaporation rate
J.	Journal
K	Potassium
KAU	Kerala Agricultural University
KCAE T	Kelappaji College of Agricultural Engineering and Technology
kg	Kilogram
kg/cm ²	Kilogram per square centimeter
KPa	Kilo Pascal
LDPE	Low Density Poly Ethylene
L W R C E	Land and Water Resources and Conservation Engineering
lph	Litre(s) per hour
m	Meter(s)
mha	Million hectare
mins	Minutes
ml	Milli litre(s)
mm	Milli metre(s)
MS	Mean Square
MSTAT	Master of Statistics
MT	Metric Tonne(s)
N	Nitrogen

No.	Number
NS	Non significant
Pa	Pascal
PE	Pan evaporation
Proc.	Proceedings
PVC	Poly Venyl Chloride
R	Wetted radius
rpm	Revolution per minute
S	Significant
S1	Sample 1
S2	Sample 2
SMMS	Second moulded micro sprinkler
Soc.	Society
SS	Sum of Squares
TNAU	Tamil Nadu Agricultural University
WCMS	Wide cut micro sprinkler
&	And
>	Greater than
<	Less than
/	Per
%	Per cent
'	Minute(s)
''	Second(s)
0	Degree(s)

INTRODUCTION

CHAPTER 1

INTRODUCTION

Water is the most important resource input of agriculture. The economy of India greatly depends on agriculture with its contribution of 50% to the Gross Domestic Product (GDP). Indian agriculture is mainly rainfed and is susceptible to all vagaries of the climate. Irrigation has a major role in the production and productivity of almost all crops. However, the presence of irrigation in Indian agriculture is still at a marginal level due to reasons such as non availability of water, lack of investing capacity, lack of efficient irrigation methods etc. It goes without saying that cost effective irrigation methods with water use efficiency is the need of the hour to protect Indian agriculture and impart food security.

Irrigation is an age old practice as old as civilization. Today, it is considered as a modern science supporting the survival of valuable crops. It may be defined as the science of artificial application of water to the crops. The ever increasing population and the consequent need for additional food supplies are forcing the rapid expansion of irrigation facility throughout the world. As more water is to be given for growing population and industrialisation, the demand for water is increasing day by day. Hence, agriculture will have to content with less allocation of water than of earlier time. Technological development in irrigation is to be explored to achieve twin objectives of higher productivity and better water use efficiency. Presently, the area under the improved method of irrigation is abysmally low in India.

The source of irrigation water is limited, at the same time, its demand for agricultural production is increasing. Therefore, the theme of water conservation would continue to command its priority and importance. Introduction of micro irrigation has already been acknowledged as a step towards judicious utilization of irrigation increasing water use efficiency. Also there is scope to minimise evaporation losses by the use of micro irrigation leading to highest water use efficiency.

1.1 Micro irrigation

Good scientific water management involves adoption of right method of irrigation consistent with the topography of the field to supply water to the crop at the right time and the required quantity. Micro irrigation can be considered as an efficient irrigation method, which is economically viable, technically feasible and socially acceptable. It has emerged as an appropriate water saving technique for row crops especially for wide spaced high value crops in water scarcity, undulated, sandy soil and hilly areas. **Micro irrigation refers to low pressure irrigation systems that spray, mist, sprinkle or drip.** Micro irrigation technologies are increasingly seen as a means of addressing the growing competition for scarce water resources. It refers to a family of irrigation systems that apply water through small devices. These devices deliver water into the soil surface very near the plant or below the soil surface directly into the plant root zone. **Micro irrigation components include main pipes, lateral tubes, water emitting devices, flow control equipment, fittings and accessories.** Today, micro irrigation is used extensively for row crops, mulched crops, orchards, gardens, greenhouses and nurseries.

The area under micro irrigation system comprising drip, bubbler, micro jet and sprinklers is steadily on the increase in commercial agriculture. Among the several methods of micro irrigation, drip irrigation has gained better acceptance among the farmers. However, the sophisticated design of its components, frequent clogging of emitters and high cost of installation are the major constraints in the large scale adoption of this technology by farmers.

1.2 Micro sprinkler irrigation

Micro sprinklers are emitters commonly known as sprinkler or spray heads. The emitters operate by throwing water through the air, usually in predetermined patterns. Depending on the water spray patterns, the micro sprinklers are referred to as mini sprays, micro sprays, jets, or spinners. The sprinkler heads can be mounted on

a support stake or connected to the supply pipe directly. Micro sprinklers are desirable in certain situations as fewer sprinkler heads are necessary to cover larger areas. The flow rates of micro sprinkler emitters vary from 20 lph to 200 lph depending on the orifice size and line pressure.

Micro sprinkler is a low discharge sprinkler that combines the advantages of the conventional sprinkler system and the modern drip irrigation system. It requires lesser energy than sprinklers and is less susceptible to clogging than of drip emitters. It has much larger area of coverage than drip emitters. In micro sprinkler irrigation system, the plant root system develops evenly due to larger volume of wetting of the soil, resulting in a denser spreading of roots throughout the wetted soil volume. This ensures better supply of water and nutrients to the plants and better anchorage. Micro sprinkler system has a wide range of application in fertigation, herbicide application, frost protection, green house and poultry house cooling, etc. The system can be run continuously or intermittently to get the desired rate of water application.

Micro sprinkler irrigation has gained better attention during recent years because of its potential to increase yields and decrease water use, fertilizer and labor requirements. Micro sprinkler irrigation applies water directly to the soil surface allowing water to dissipate under low pressure in a wetted profile that uniformly meets water demand throughout the area. With micro sprinklers, the amount of water required by the plants is applied to a given volume of soil. This enables the root system to develop evenly and to spread densely throughout the volume of wetted soil, thus ensuring the supply of water and nutrients to the crop. This serves as an advantage over the drip irrigation system, because the roots of the drip irrigated trees will be concentrated in a shallow, small volume of soil under the dripper. Micro sprinklers with its large diameter wetting pattern is especially desirable in areas with coarse textured soils where lateral movement of soil water is limited. The greater diameter of coverage results in greater soil moisture reserve.

The examination of micro sprinkler for its water application rate and distribution pattern is required for the development of new prototypes, manufacturer's quality control and sprinkler evaluation by consumer organizations. Uniformity is an indicator of the quality of the application rates within the pattern diameter of an emitter. The devices should be tested before field installation to verify the quality of the emitters. Moreover, such tests will help the manufacturers to improve the design of their products and the end users will get a general guideline for the selection of such products.

1.3 Mulching in micro irrigation

The loss of water from the field can be reduced by covering the soil surface around the inter-plant area with organic or non organic materials known as mulches. Dry leaf, paddy straw, paddy husk, dry grass, saw dust, coconut husk, coconut leaves, paper etc. are some of the materials used for mulching. Besides these, plastic films such as Low Density Poly Ethylene (LDPE) films, Ethyl Vinyl Acetate films, etc. are also used as mulches to reduce evaporation.

Organic mulches decay over pass of time and are temporary in nature. The benefits of mulching are to prevent the loss of water by evaporation and transpiration, keep down weeds due to soil solarisation/heating, dampen temperature fluctuations, increase soil moisture storage and more uniform moisture distribution in the root zone. It increases water intake rate and water storage capacity, reduces run off and soil losses, prevents crusting and soil compaction, reduces blowing and beating action of water and wind, facilitate faster germination and emergence (up to 30 days early), permits early maturity, leads to faster crop growth and development and prevents leaching of water and nutrients.

It has been observed that different mulches with varying optical properties influence the degree of soil warming, owing to insulation and energy reflection. With light coloured material like paddy or wheat straw, energy reflection will be more than

from bare soil surface. There are many advantages for paper mulches. Being biodegradable, they are environmentally friendly. At the same time, they keep the soil moist, which is desirable in areas where summer is hot and dry. As time passes, paper decomposes and adds organic matter to the soil.

Hence, micro sprinkler irrigation along with mulch helps to achieve both the objectives of efficient utilization of available water and conservation of soil moisture. Therefore, the present thesis work is an attempt to study the performance of a simple and novel micro sprinkler developed by a farmer 'Avaran', with the following objectives.

1. To evaluate the hydraulic performance of a farmer developed novel micro sprinkler.
2. To develop a technology to produce low cost and standardised micro sprinklers on large scale.
3. To determine the best combination of irrigation level and mulch for the micro sprinkler for cucumber crop (*Cucumis melo var. conomon*).

REVIEW OF LITERATURE

CHAPTER 2

REVIEW OF LITERATURE

2.1 Micro irrigation

Micro irrigation is a low pressure, low discharge irrigation system suitable for high value crops such as fruits and vegetables. If managed properly, micro irrigation can increase yield and at the same time decrease water, fertilizer and labor requirements. Micro irrigation applies the water only to the plant's root zone and saves water because of the high application efficiency and high water distribution uniformity. Micro irrigation can irrigate sloping or irregularly-shaped land areas that cannot be flood irrigated. Any water-soluble fertilizer may be injected through a micro irrigation system.

Anwar and Aswani. (1980) reported that micro irrigation is an efficient method of providing irrigation water directly into soil at the root zone of plants. It permits the irrigation to limit the watering closely to the consumptive use of plants. It also permits the utilization of fertilizer, pesticides and other water-soluble chemicals along with irrigation water with better crop response. Micro irrigation conserves irrigation water easily doubling the command area of a water source with yield increase upto 50%.

Micro irrigation is the frequent application of small quantities of water directly on or below the soil surface. Usually water is applied as discrete drops, continuous drops, tiny streams or miniature spray through devices placed along a water delivery line (BIS 1987).

Micro irrigation may be described as a method of applying low volumes of water directly to the root zone of the crop and limiting it to the root spread volume of the soil layer. Micro irrigation systems are typically designed to wet only the root zone and maintain this zone at or near an optimum moisture level (James, 1988).

Micro irrigation is defined as an irrigation method that applies water to less than 100% of a crop area. This includes drip, micro jet and micro sprinkler irrigation systems. The design principles are similar for micro sprinkler and trickle systems (Cuenca and Richard, 1989).

Boman (1999) studied micro tubing effects on micro sprinkler discharge rates. Variations in discharge rates were examined to determine the effects of system operating pressure and the diameter of micro tubing. When micro tubings were used even the emitter with smallest orifice diameter had 5-10% reductions from specified flow rates.

Since scarcity of water is a major problem in semi-arid and arid areas of Spain and many other Mediterranean regions, water consumption in irrigated agriculture has to be reduced to a sustainable level that is also adapted to the environment. This goal can be reached by applying the highly effective and resource preserving techniques of micro irrigation. Compared to other irrigation methods, the high irrigation efficiency achieved by this system was outstanding. Minimum maintenance requirement and a long life span are additional positive characteristics of the system. The beneficial outcomes of this system give reason for an optimistic appraisal of the strategies involved towards sustainable irrigated agriculture (Barth, 1999).

Asokaraj (2001) conducted a study in micro irrigation and reported that micro irrigation, which includes drip and micro sprinklers, is an effective tool for conserving water resources. The studies revealed significant water saving ranging between 40 and 70% by drip irrigation compared with surface irrigation, with yield increasing as high as 100% in some crops in specific locations. The water saving by adoption of this technology would also pave way for increasing the irrigated area under food grains for India's ever increasing population.

Although water is a renewable resource, stress in the availability of water to meet the growing demand of the rising population has been increasing. Therefore

efforts have been on for employing more efficient method of irrigation like drip/micro irrigation. Since most of the fruit crops are planted on rows, they are ideally suited for micro irrigation. On an average about 30,000 ha area is being brought under micro irrigation annually under horticultural crops (Jose, 2001)

Micro irrigation has been recognized as an answer to meet the increasing demands of water for irrigation with an efficiency of about 95%. It ensures increase in crop yield, higher quality of crops, less water and energy consumption, less weeds and less soil compaction. Evaluation study on the impact of micro irrigation programme reveals that farmers who had installed drip irrigation sets invariably introduced high-value horticultural crops like grape, banana, mango, cashew nut and coconut (Singh, 2001).

In India, the area of irrigation of fruit crops is only about 30% and the average productivity is very minimum. Drip irrigation can increase productivity and also the quality of fruit crops. Therefore, it is planned to bring atleast 2 million ha under micro irrigation by the year 2020/25 (Sivanappan, 2001).

Rolbiecki (2007) conducted a study to recognize the possibilities of zucchini (*Cucurbita pepo* L.) cultivation on a sandy soil under drip and micro sprinkler irrigation systems. In the framework of investigation, three field experiments were conducted in a randomized blocks method of a two-factorial 'split-plot' system with four replications. The average yield increase for both systems of irrigation equaled 26 t ha⁻¹ (85%).

Cigdem *et al.* (2008) carried out a study to determine the effects of different water application levels on the vegetative growth, flower bud formation and yield of sweet cherry trees irrigated by micro sprinkler systems. The trees were subjected to five irrigation treatments based on Class A pan evaporation ($0.50E_{\text{pan}}$, $0.75E_{\text{pan}}$, $1.00E_{\text{pan}}$, $1.25E_{\text{pan}}$, $1.50E_{\text{pan}}$). Mean yield per tree and trunk cross sectional area was 0.70-2.40 kg and 0.01-0.05 kg/cm² respectively at different irrigation water levels.

Irrigation levels did not affect, statistically significantly, fruit quality parameters such as fruit weight, flesh/seed ratio, water soluble solids, pH, titratable acidity and inverted and total sugars. Only flesh firmness values were statistically significant at probability level with respect to the irrigation levels.

Studies were conducted by Singh *et al.* (2009) to standardise the package of practices of strawberry cultivation with modern techniques under northern Indian Plains. Micro irrigation system has been found to be quite successful for its remunerative cultivation. Use of micro sprinkler during early stage and drip system during flowering and fruiting has given encouraging results. Further, with the use of micro sprinkler plant mortality was reduced and enhanced fruit yield significantly compared to the traditional method and increased the period of fruit availability.

Jadhav *et al.* (2011) conducted a study to evaluate the effect of nozzle size and operating pressure on performance of medium volume rain gun (8, 10, 12 and 14 mm diameter size). The system was operated at various operating pressures viz. 2, 3, 4 and 5 kg/cm². The increase in nozzle size and operating pressure increased the discharge of medium volume rain gun. Jet length was also found to be increased in operating pressure.

2.1.1 Classification of micro irrigation

Micro irrigation systems include low pressure, low volume irrigation systems and can be sub divided into four main methods according to pressure and volume (Barret, 1979). Drip irrigation applies water directly to the soil surface or subsurface and allows the water to dissipate under low pressure in a pre-determined pattern. The other three methods viz., mist, sprayer and mini sprayer methods that convey water through the air can be termed as micro-sprinkler systems. The wetted area of these emitters is small, can be controlled fairly easily and has different shapes to match the desired distribution pattern.

Micro irrigation spray and spinner emitters were characterized by Post *et al.* (1985) as devices having operating pressure less than 2kg/cm^2 , discharge rates in the range of 20-100 lph and throw diameters ranging from 1.5 to 10m. Losses due to surface evaporation and deep percolation are avoided in this method. The system is required for water scarce areas and is largely confined to fruit crops, widely spaced vegetables etc. (Walker and Skogerboe, 1987).

The concept of micro irrigation though simple, was not practiced widely until very recently due to lack of economic materials. The first experiments leading to the development of micro irrigation were introduced by German researchers in 1860. They pumped irrigation water into short clay pipes with open joints used for underground drainage, to maintain a water table near the plant root zone. In the 1920s porous pipe and canvas was used for subsurface irrigation at Michigan State University, and subsequent experiments were centred on development of perforated pipes made of various materials and on control of flow through the perforations (Bucks and Davis, 1986).

2.1.1.1 Drip irrigation

The discovery of high density polyethylene (HDPE) in 1948 made the breakthrough for micro irrigation. A significant step in the evolution of trickle irrigation took place in Israel in the late 1950s when long path emitters were greatly improved. By the early 1960s plastic pipe micro irrigation systems were being used extensively in greenhouses in most commercial enterprises. Drip irrigation was first tried on a commercial scale for vegetables in Israel, in 1960s in the Arava valley. In 1969, the first research and demonstration study of micro irrigation was initiated on an avocado orchard in California (Gustafson *et al.*, 1974). Around the same period, field trials were conducted using surface micro irrigation on strawberries and tomatoes, also in California (Hall, 1985). It soon became apparent that drip irrigation almost doubled the yields. The large scale and commercial use of micro irrigation began in the late 1960s and early 1970s. Numerous inventors and companies began

developing drip irrigation emitters, and by mid 1970s well over 250 emitter devices were being marketed.

The interest of micro irrigation was more in Israel, USA and the Middle East since these areas suffered very high shortage of irrigation water. In recent years, farmers have made wide use of pressurized irrigation systems to increase crop yield. The drip (trickle) irrigation system is the most important of these systems and has contributed to a marked increase of yield under open-field and greenhouse conditions in the past decades in Turkey. Its use is increasing rapidly for vegetable and field crops (Oron, 1984).

Drip irrigation relies on the concepts of irrigating only the root zone of a crop and maintaining the water content of the root zone at near optimum level. Irrigating only a portion of the land surface limits evaporation, reduces weed growth, and minimizes interruption of cultural operations. Maintaining near-optimum water content in the root zone usually involves frequent application of small amounts of water (James 1988). These small amounts of water prove high water use efficiency (WUE) and higher yield and quality of crop through drip irrigation.

The trickle system transports water through an extensive pipeline network to the soil near the plant and puts the water directly into the root zone. Trickle irrigation methods are high frequency-low discharge, localised over a long period of application, have a low-pressure requirement, and apply water near or into the plant's root zone (Bucks and Davis 1986).

Israel started using the modern-day surface trickle system in 1963, and the United States started using it in 1964. Today, studies are done on the design, operation, and management principles of the trickle system (Davelly *et al.*, 1973). Its advantages, disadvantages, and the effects on the crop yield are subjects of intensive study throughout the world (Mostaghimi *et al.*, 1981)

Drip irrigation has contributed to a marked increase in agricultural yield over the past decade. One snag in this technique is that, in contrast to the other methods, it is not applicable to all plants and land types. Before and following the years of World War II, British farmers used plastic pipes in drip irrigation on land and in greenhouses (Goldberg *et al.*, 1976; Hall, 1985). Publications on the present-day surface trickle system began to appear from Israel in 1963 and United States in 1964, although research and development in both countries started some years before (Bucks and Davis, 1986). Several researchers in the 1970s and 1980s studied design and project planning for drip irrigation systems (Keller and Karmeli, 1975).

Drip irrigation is also called low-pressure irrigation, because it is a low-pressure system. It takes water through drippers or injectors. Water leaves the dripper at zero pressure and gravity moves it to the soil and downward. The distribution in the soil has the shape of an onion. The lateral flow of the water in the soil limits the area each dripper wets.

2.1.1.2 Micro sprinkler

Micro sprinklers are low discharge sprinklers that operate at low pressures. The concept of micro sprinklers was materialised in the beginning of 1980s as an improvement over the drip irrigation system, by replacing the trickle emitters by low discharge, low pressure sprinklers in the drip irrigation network. They have been introduced to the world of irrigation by fusion of the peculiarities of drip irrigation and sprinkler irrigation methods.

Micro sprinkler has low volume of water to be sprinkled at a low rate and allowed to fall back either on the canopy or soil surface covering part of the area allotted to each tree with a small sprinkler which works under low operating pressure ranging from 1-2 kg/cm² with wetted diameter of 4 m (Kulkarni, 1987).

Micro sprinkler is a versatile means of applying water to plants. The design principles are similar for micro sprinkler and trickle systems (Cuenca and Richard,

1989). It requires less energy than conventional sprinkler and less susceptible to clogging than drip emitters (Singh and Singh, 1990).

Saving due to micro sprinkler is reported to the extent of 30-60 per cent over traditional methods of irrigation (Mane *et al.*, 1987).

The spray pattern of different micro sprinklers is varies as per manufacturer's specifications. (Aragade and Thombal, 1994). Demand of micro sprinklers increased greatly when it was found they could provide frost and freeze protection. The maximum water use efficiency reported under micro sprinkler system for the crop chilli was 167.42 kg/ha/cm (Shinde, 1995). New citrus planting during and after the severe freezes of the 1980s made Florida one of the fastest growing markets for micro sprinkler irrigation between 1985 and 1990 (Smajstrala, 1995).

Research works carried out at the agronomic Research station, Chalakkudy, Kerala agricultural University by Suseela *et al.* (2006) has resulted the development of a low cost, simple and farmer friendly micro sprinkler head called "bubbler head", which was later renamed as "KAU micro sprinkler". It is very simple in design and clog-free system of irrigation, ensuring complete wetting of the basin area (> 90%) of the crop due to its rotating action. The discharge rate of this micro sprinkler was found to be 35-76 l and effective wetting radius of 1.65 m to 0.5 m.

A study conducted by Ceres *et al.* (2009) proposed a novel micro sprinkler system that uses micro tube as the emitter and where the length of the micro tube can be varied in response to pressure changes along the lateral to give uniformity of emitter discharges. They have developed and validated empirical and semi-theoretical equations for the emitter hydraulics. Laboratory testing of two micro tube emitters of different diameter over a range of pressures and discharges was used in the development of the equations relating pressure and discharge, and pressure and length for these emitters. The equations proposed will be used in the design of the micro sprinkler system, to determine the length of micro tube required to give the nominal discharge for any given pressure.

Rao *et al.* (2010) conducted a field experiment to study the response of Cumin (*Cuminum cyminum* L.) to variable irrigation through micro sprinkler, organic manure and nitrogen under semi-arid environment. The maximum irrigation water productivity was recorded at 0.8 IW/CPE ratio where 40 mm less irrigation water was applied indicating that water was utilized efficiently under this irrigation schedule as compared to 1.0 IW/CPE ratio. Farmyard manure at 10 tonnes/ha increased cumin seed yield significantly by 12.5% (613 kg/ha) over control (546 kg/ha) and water productivity to 0.313 kg/m³ from 0.277 kg/m³.

2.2 Micro sprinkler irrigation system

Micro sprinklers are becoming a preferred irrigation method for water application. Micro sprinkler irrigation has gained attention during recent years because of its potential to increase yields and decrease water use, fertilizer and labour requirements. Micro sprinkler irrigation applies water directly to the soil surface area allowing water to dissipate under low pressure in a wetted profile that uniformly meets water demand.

Although sprinkler irrigation and drip irrigation methods are adoptable means of applying water to any crop, soil and topographic conditions, each of these methods has its own demerits also. The micro sprinkler system combines the merits of both the systems and avoids most of the demerits.

Davies *et al* (1988) detailed the special adaptability of micro sprinkler systems to difficult situations. Besides the adaptability over a wide range of soil, crop and topographic conditions, some other objectives that can be attained using micro-sprinkler are,

1. Effective use of small, continuous streams of water such as from springs and small tube or dug wells.

2. Proper irrigation of problem soils with inter mixed textures and profiles or the irrigation of shallow soils that cannot be graded without detrimental results.
3. Irrigation of steep rolling topography without runoff or erosion.
4. Effective, light and frequent watering may be possible whenever needed.
5. The micro sprinklers are highly adopted to water sensitive crops where wetting of upper portion of the plant is undesirable.

Spray or spinner micro sprinklers are often preferred over drip systems since they have provided a larger diameter wetting pattern. This characteristic is especially desirable in areas with coarse textured soils where lateral movement of water in soil is limited (Boman, 1989). The greater coverage diameter allows a larger percentage of the root zone to be wetted by the irrigation and can result in greater soil moisture reserve and better root development.

Micro sprayer emitters have low precipitation rates, which typically are, less than 4mm/h. Thus by applying the right amount of water at the correct irrigation rate, there will be no seepage beyond the root zone, or the problem of decreased aeration in the root zone, caused by water logging. Considerable saving in water will result in going for micro sprinkler irrigation system. They wet only 40-80% of the soil surface in a mango orchard. The area wetted by the micro sprinkler can be adjusted according to the development of the root system (Chaya and Hills, 1991).

Koumanov *et al.* (1997) conducted a study to quantify the components of the water balance of an almond tree under micro sprinkler irrigation. Neutron probe readings at 15 cm depth increments and tensiometer readings were taken 4 to 6 times daily. Evaporation losses of the wetted area were estimated to be between 2 and 4 mm/irrigation event. Consequently, application efficiencies were only 73-79%, the wetting of the root zone was limited to the 0-30 cm depth interval only, the soil

profile was depleted of soil water, and daily crop coefficient values at days between irrigation events were between 0.6 and 0.8.

A field experiment was conducted by Awari *et al.* (2001) on Chilli (*Capsicum annum* L) under micro sprinkler irrigation system with different irrigation interval and irrigation level treatments during 1996-97. A non-significant effect was observed for consumptive use efficiency and yield of dry chilli among the treatments. The maximum yield was recorded in three days irrigation interval treatment and in treatment combination of five days irrigation interval with 0.7 CPE level. Also, the consumptive use efficiency was recorded highest in treatment combination of four days irrigation interval with 0.7 CPE level.

A study was conducted by Mandal *et al.* (2003) during 2003–04 to compare micro sprinkler, drip and furrow irrigation systems for potato (*Solanum tuberosum* L.) production at Central Institute of Post Harvest Engineering and Technology, Ludhiana. Each irrigation method was combined with 4 irrigation levels, ie IW/CPE ratio of 1.20, 1.00, 0.80 and 0.60. Better crop performance was recorded under micro sprinkler regime. The highest potato yield (31.60 tonnes/ha) was obtained with micro sprinkler when irrigation was scheduled at 1.20 IW/CPE. Highest water-use efficiency (1.37 q/ha/mm) was recorded with 0.80 IW/ CPE under micro sprinkler irrigation. Economic analysis revealed that using micro irrigation for potato production in semi-arid environment is a profitable alternative of existing irrigation method.

Tomar (2003) conducted a field experiment in the foot hills of the Himalayas to study the response of Bush snap bean to drip, micro sprinkler and conventional surface method of irrigation. The value for all the biometric characteristics, seed weight and seed: husk ratio was found on the higher side for micro sprinkler irrigation.

Between 2002 and 2004, passive capillary wick samplers were used to test the effects of micro irrigation systems (drip and small radius micro sprinklers). Irrigation was automated and applied twice daily based on ET estimates from an electronic atmometer. Over-supply resulted in greater losses under drip than micro sprinkler, particularly close to the emitter (Neilson *et al.*, 2008).

Satyendra *et al.* (2008) made an effort to determine the optimal water allocation to potato crop with micro sprinkler irrigation system. Results of the study indicated higher yield at 1.2 Ep irrigation level, whereas water use efficiency was found to be maximum at 1.0 Ep. This study indicated that reduction in water application from 280 mm to 247 mm increased net profit by 7%.

Satyendra *et al.* (2009) carried out field investigations for 3 years with the aim of studying the feasibility of using micro sprinkler and drip irrigation systems for vegetable production in a canal command area. Increased crop yield with micro sprinkler and drip irrigation is the factor behind higher profitability than existing surface irrigation. The overall results of the present study favoured micro sprinkler over existing irrigation methods for onion production in a canal command area with higher profit under limited available surface water.

Asin *et al.* (2011) conducted a study to increase fruit wetting at night by irrigating 1 mm/day using micro sprinkler. Irrigation was performed every day at midnight, from the end of petal fall, and for a period of 40 days. Applying micro sprinkler irrigation significantly increased fruit russet compared to the untreated control in the first two years. For all three years, the percentage of fruit in the extra russet category (with russet on over 50% of their surface) was 10% higher in the micro sprinkler trial than in the untreated control (36 Vs. 26%).

2.2.1 Comparison of micro sprinkler irrigation with other methods

The micro sprinklers are generally used for under-tree sprinkling in orchards and for widely spaced crops. The wind drift losses are less compared to conventional

sprinkler system due to shielding by the canopy and lesser wind velocities near the ground.

In conventional sprinklers, large droplets having higher kinetic energy disrupt the soil surface causing reduced infiltration rate due to crusting (Dadiao and Wallender, 1985). This does not occur for micro sprinklers, thus preventing losses by runoff, and they apply the right quantity of water only, so that no anaerobic condition is developed within the root zone.

The micro sprinklers are generally operated at a low pressure range of about 1-2 kg/cm², which is very low as against the high pressure operation of conventional sprinkler systems and comparatively high as compared to the operation of drip irrigation systems. Obviously, considerable saving in pumping energy can be attained with micro sprinklers over conventional systems. The combined effect of larger nozzles and higher operating pressure minimises the chance of clogging. Singh and Singh (1990) states that micro sprinklers require lesser energy than conventional sprinklers and are less susceptible to clogging compared to drip emitters.

Compared to other methods of irrigation, the micro sprinkler system has proved to be efficient, water, energy and labour saving, trouble free and economical. Saving of water due to micro sprinkler is reported to the extent of 30 to 60% over traditional methods of irrigation (Mane *et al.*, 1987 and Bankar, 1992). This is due to the partial wetting of the soil volume, reduced runoff and controlled deep percolation losses.

The canopy to active root ratio is much better under micro sprinkler than drip irrigation system. Roots of drip irrigated trees are concentrated in a shallow, small volume of soil under the dripper, whereas a large number of roots penetrated to depth of 70-80 cm in areas irrigated by micro sprinklers. Since visual inspection of the micro sprinkler system is simple and fast, less time is required than for the inspection of several emitters per tree in a drip irrigation system.

The only notable disadvantage associated with micro sprinkler irrigation system as compared to the drip system is the enhanced weed growth caused by the large area of wetting, which can be solved by the use of herbicides along with irrigation water.

2.3. Performance evaluation of micro sprinkler irrigation

The performance of micro sprinkler has been assessed commonly using catch can methods with the cans placed in full wetted area or part (one quarter) of the wetted circle (Post *et al.*, 1985; Boman, 1989; Pandey *et al.*, 1995).

The technique of catch can test is the suitable method for the performance evaluation of spray type irrigation systems. ASAE (1991), ASAE (1997) and BIS (1987a) describe the general procedure for catch can testing and other standard methods of testing of sprinkler systems.

The hydraulic design of micro irrigation systems to achieve high system uniformity has led design engineers to over-design irrigation systems arbitrarily. Commonly used emitter flow variations of 10-20% are equivalent to a uniformity coefficient of about 98-95%, or a coefficient of variation of emitter flow of only 3-7%. The uniformity of a micro irrigation system is affected by not only hydraulic design but also manufacturer's variation, grouping of emitters, plugging, soil hydraulic characteristics and emitter spacings. Among all the factors affecting the uniformity, the hydraulic design, with an emitter flow variation of 10-20%, produces only a few percent changes in uniformity (Pai, 1997).

In a purely volumetric sense, the efficiency of the system should be determined as the ratio of the water used by the plant to the water input. While the ultimate volumetric output of the irrigation system is the water used by the plant, the output product from the whole farming system is commonly viewed as the marketable crop of economic returns (Dalton and Raine, 2000).

Holzapfel (2011) evaluated micro sprinkler irrigation system in apple orchard under different soil characteristics in a 100 ha apple farm. The evaluation was done using the Christiansen Uniformity Coefficient (CUC), the Efficiency of Low Quarter (ELQ_{25%}) and Total Efficiency Distribution (TED). The CUC and ELQ_{25%} were 84 and 79%, respectively, whereas the average TED was 23%, due to the excess of water applied, of up to 100% in the irrigation times in some sub-units. The operation efficiency of the pumping systems took values from 33 to 87%, an increase resulting from changes in the discharge required by every subunit in the micro sprinkler systems.

Since irrigation uniformity is an important component of the evaluation of field performance and the determination of application efficiency often involves the crop yield produced or value obtained at the farm level; the performance of single non-overlapping micro sprinkler systems that can be evaluated on the basis of irrigation uniformity. Since the uniformity of distribution of irrigation water applied by a micro sprinkler is the primary factor that determines the application efficiency, a measure of the distribution uniformity can better describe the performance of the system.

2.3.1. Performance indicators

It is difficult to evaluate irrigation performance using a single parameter. Hart (1972) suggests that it is necessary to use three efficiency terms and one distribution uniformity term to adequately describe the hydraulic performance of an in-field irrigation system. A large number of indices for the assessment of irrigation performance have been proposed. Willardson (1972) stated that at least 20 definitions of irrigation efficiency existed at that time.

Different performance indicators (dimensionless coefficients) are used to describe the performance of micro sprinkler. A wide range of irrigation uniformity coefficients are commonly used in performance evaluation (Jenson, 1983). The

different coefficients commonly used in performance of micro sprinkler are uniformity coefficient (UC), distribution uniformity (DU), coefficient of variation (COV), distribution characteristic (DC), distribution pattern and scheduling coefficient (SC). However, Walker (1993) used two efficiency and one uniformity term. At the system or whole farm level, a range of performance parameters may be appropriate depending on the spatial and temporal boundary conditions established for the evaluation (Dalton and Raine, 2000).

2.3.1.1. Uniformity coefficient

One of the basic measures of any irrigation system's performance is Christiansen's uniformity coefficient, CUC (Christiansen, 1942). Christiansen defined the uniformity coefficient as

$$\text{CUC} = 1 - (D/M); \text{ where}$$

D is the average absolute deviation of irrigation amounts, and M is the average irrigation amount.

2.3.1.2 Coefficient of variation

The coefficient of variation, COV, of application depths for a particular emitter is calculated by dividing the standard deviation of depths by mean of the depths. Since COV is a measure of the deviation of individual depths compared to the average depth, higher values of COV describe poor performance of the system and vice versa. COV is expressed as a percentage.

Boman (1989) evaluated several micro irrigation emitters to determine their uniformity of distribution. The coefficient of variation of catch depths was selected as the primary performance indicator for the study. The author stated that COV is independent of the scale of measurement, and thus allows dimensionless comparison of variability for emitters with different flow rates. The COV values less than 100% can be considered as good water distribution and values over 200% indicate patterns that have a large portion of the effective area that receive no water. These high COVs

may also signify that the pattern has areas with very high application depths relative to the mean.

Pandey *et al.* (1995) determined the performance parameters such as average application rate, absolute maximum depth and coefficient of variation by single nozzle test for five makes of micro sprinklers, designated for reference as A,B,C,D and E. The range of mean depth at varying pressures and heights for micro sprinklers A, B, C, D and E respectively were found to be 2 mm, 6 to 4 mm, 16 to 5 mm, 3 to 2 mm and 9 to 2 mm and the range of COV were found to be 254 to 76%, 207 to 90%, 189 to 66%, 199 to 105% and 215 to 63% respectively.

2.3.1.3 Distribution uniformity

The distribution uniformity coefficient is usually used by the engineers who often combat with dry spots in the irrigated area, rather than well-watered or wet spots. The use of the “lowest 25%” is purely arbitrary and bears no relationship to the crop’s growing characteristics.

According to Farbman (1992) the factors affecting application uniformity were head losses along the laterals and manifolds, elevation differences within the plot, variability of emitter performance, clogging of emitters, drainage of water balance before pressure build up and after shut off.

Amir and Dag (1993) reported that high application rate increases the uniformity and width of the wetting pattern and decreases the depth of water application. Low volume micro irrigation sprinklers spaced 3 to 3.7 m apart had coefficient of uniformity values between 87% and 95%. The distribution uniformity coefficient (DU) is also widely used for spray systems. It takes into account the variation of can readings from the mean but concentrates only on the lowest 25% of the readings. The range of DU values for sprinkler distributions will be similar to CUC; however, due to method of calculation, DU will generally be lower. For

example, for a system with CUC of 85%, D_u will be approximately 78% (Conellan, 1994).

Emission uniformity E_U has been one of the most frequently used criteria for micro irrigation design and evaluation. Uniformity expressions of a micro irrigation system can be shown in many forms from the simple range of maximum to minimum emitter flow, or minimum to mean emitter flow E_{UK} , or emitter flow variation q_{var} to the statistical terms, such as uniformity coefficient of Christiansen (CUC) and coefficient of variation (COV). For a micro irrigation system designed for high uniformity all the uniformity expressions are highly correlated to each other (Barragan *et al.*, 2006).

Micro irrigation can apply water with high uniformity. However, uniformity alone is not sufficient to achieve the goal of irrigation. It is important to specify that the differences in total return and water saving between different schedules are reduced when high uniformity is applied in the design. Since a high proportion of water resources are used for agricultural production, micro irrigation systems designed with high uniformity can be scheduled to achieve water conservation as well as environmental protection (Barragan *et al.*, 2010).

2.3.1.4 Distribution characteristic

Unlike impact sprinklers, micro irrigation emitters generally are located in the field with non-overlapping patterns on widely spaced plants. Merriam and Keller's (1978) distribution characteristic (DC) is the standard method for evaluating the non-overlapping sprinklers. The DC is defined as the ratio of the area that receives more than half of the average application to the total wetted area, expressed as a percentage. The authors suggested that DC value greater than 50% are probably satisfactory and that very good patterns result with DC values greater than 66%.

Although DC is the standard method for the evaluation of non-overlapping sprinklers, other methods are also used either alone or in combination with one

another. Post *et al.* (1986) recommended that using additional performance indicators in addition to DC for better characterizing emitter performance. The coefficient of variation was the indicator suggested by him.

2.3.1.5 Distribution pattern and densogram

The distribution pattern or spray coverage pattern is formed by a collection of curves (isograms) plotted by connecting the interpolated points of equal application rates within the wetted area. This gives a rough idea of how the emitter applies water to the irrigated area. A good emitter should produce circular isograms of decreasing application rates from centre to outer perimeter of the wetted area.

Christiansen (1942) was probably the first to point out the significance of distribution pattern in assessing the performance. The distribution pattern of a sprinkler gives water application rates (or depths) as a function of the radial distance from the sprinkler. The distribution pattern is affected by the combination of nozzle size and pressure as well as the sprinkler model itself.

The densogram is a modification to the distribution pattern. The densogram gives a good visual impression of distribution of irrigation water; it does not provide quantitative means to actually measure the uniformity.

A non-quantitative way to look at the wetted area is graphically displayed using a shading technique. This process transforms the actual catch values into various intensities of shades. The dot matrix printer shading technique used by Centre for Irrigation Technology, Florida is to transform the application rates to different intensities/densities of dots. The wettest area is displayed as black (solid dots); all other application amounts are scaled between black and white (white represents area receiving no water or the dry spot) with corresponding shades or densities of dots. The resulting densogram gives an excellent visual description of where high and low watering spots are, how wet or dry they are; and in general, how uniform the water application is.

Boman (1989) has experimented several micro sprinklers to determine their individual performance. He reported that the application rate of several micro sprinklers was not very uniform. Some emitters put out a 'doughnut' pattern where more water is thrown to the outside and less remains near the centre. Only one of the emitters tested had a DC value greater than 50%. Apparently, low DC values (less than 50%) are typical for micro-irrigation sprinkler and spray emitters. The average COV values for the spray emitters tested were 181%, 165%, 167%, and for the spinner emitters were 101%, 71% and 73% respectively for the 103, 138 and 172 KPa tests. The higher COV values in the 103 KPa tests were due to a more pronounced doughnut effect in some of the emitters at the lower pressure. This problem is common for high-pressure sprinklers that are operated at too low pressure.

In drip and micro sprinkler with the increase in water application, the moisture content of soil increased horizontally and vertically. The moisture content was in the range of 76 to 100% and 71 to 100% of field capacity under micro sprinkler and drip irrigation. In both the irrigation systems the accumulation of salt was found to be maximum at the periphery of wetted area (Arulkar *et al.*, 2008).

2.4. Mulching

Mulching is the practice of covering the soil around plants to make conditions more favorable for growth, development and efficient crop production. Both natural and artificial materials are used for mulching materials. Natural mulches such as straw, paddy husk, coir pith, saw dust, compost, etc. are in use for centuries. The advent of synthetic materials like polyethylene, polyvinyl chloride and ethylene vinyl acetate have altered the methods and benefits of mulching. Many scientists from all over the world have reported that mulching increased the growth and yield of the plant.

The effect of soil mulching polyethylene and some biodegradable alternatives on weed control and tomato (*Lycopersicon esculentum* L.) growth and yield was evaluated by a study conducted by Anzalone *et al.* (2010). The mulch treatments

were rice harvest residues, maize harvest residues, wood sawdust, Kraft paper and silver-black non degradable polyethylene, untreated, hand weeding and herbicide. The best vegetative growth was obtained by plastic and paper mulches. The polyethylene mulch gave the highest tomato yield, followed by paper and maize harvest residues mulches. Results show that paper and vegetal mulches could be excellent biodegradable alternatives for weed control and increasing growth and tomato yields in semiarid tropical regions.

A two year field experiment was conducted by Weon *et al.* (2011) to evaluate the effects of paper and plastic mulching with hairy vetch alone or in combination with barley on weed control and rice yield. The results showed that plastic film (10 or 20 μm) and paper mulching with hairy vetch alone had no significant effects on weed density and rice yield when compared with conventional practice during the first year. However, during the second year, plastic film (20 μm) with partial tillage of hairy vetch alone increased rice yield and decreased weed occurrence; but barley and hairy vetch mixture showed opposite trends. Plastic film mulching led to a decrease in soil redox potential, mainly due to the absence of decomposed soil organic matter.

2.4.1 Effect of natural mulching on growth and yield of crops

Rajput and Singh (1970) have reported that straw mulch conserved higher soil moisture to an extent of 55 per cent more compared to control. Average available soil moisture stored up to 1.5 m depth of soil increased significantly by mulching of wheat residue at 6730 kg/ha compared to bare soil. Lal (1978) reported decreases in bulk density under straw mulch (1.42 g/cm) compared to bare soil (1.50 g/cm). In heavy black soil also, application of mulches like coir pith at 20 t/ha, press mud at 10 t/ha decreased the bulk density over control (Mayalagu, 1983). Koni (1983) found that sorghum stubbles, cotton stubbles and maize stubbles as mulch in chilli conserved more moisture compared to control.

Okra production was significantly higher under straw mulch followed by dust mulch over control (Batra *et al.*, 1985). Sood and Sharma (1996) reported similar beneficial effects of mulching through improvement of soil environment resulting in better plant growth and tuber yield of potato. Application of straw mulch at 6 t/ha increased yield of tomato and okra by 100 and 200 per cent, respectively over control (Gupta and Gupta., 1987). In okra, the highest uptake of N, P and K was observed in sugarcane trash mulched plots over unmulched (Vethomoni and Balakrishnan, 1990).

Rose *et al.*, (1994) reported that organic mulch gave highest fruit yield of bell pepper over control. Similar results were also obtained by Hassan *et al.*, (1994). Mulching with coconut fronds increased leaf N, P and K content in chilli. Chakraborty and Sadhu (1994) reported that water hyacinth mulch was better than rice straw mulch for increased fruit number and size of tomato. The yield of potato was the highest under paddy straw mulch (27.9%) and also starch content was highest in paddy straw mulch (18.18%) than unmulched plot (Dixit and Majmudar., 1995). Aref *et al.* (1996) reported that application of hairy vetch mulch recorded significantly higher yield of tomato (32%) than bare soil.

Hedge *et al.* (1994) conducted a study to find out the effect of mulches and cover crops on Robusta banana. The treatments consisted of two mulches, rice straw and black polyethylene, and four cover crops along with a control (no mulch and control crops). Water use of banana was lowest under the polyethylene mulch, followed by straw mulch, and was highest when banana was raised with cover crops. The evapotranspiration under polyethylene mulch decreased by 8% and 14% compared with that under straw mulch and no mulch. Water use efficiency was highest under polyethylene mulch, due to higher yield and reduced transpiration.

Patra *et al.* (1994) conducted a two year field study in which Japanese mint plants were mulched with rice straw and citronella distillation waste, and controls were not mulched. Herb yield was increased by 17% and 31% with rice straw and

citronella distillation waste respectively, compared with controls. The essential oil yield was also significantly increased.

A field experiment was conducted by Pulekar *et al.* (1996) to study the effect of irrigation schedules based on cumulative pan evaporation with and without grass mulching on two varieties of bhindi. The results revealed that scheduling of irrigation at 50 mm cumulative pan evaporation with 50 mm of water in conjunction with dry grass mulching significantly increased green fruit yield in both varieties of bhindi as compared to other treatments.

Organic mulches induced earliness in flowering, less days to fruit set and days to harvest, also increased number of flowers and per cent fruit set in tomato crop over control (Ravinder and Shrivastava, 1998).

A field evaluation by Hochmuth *et al.* (2001) of the University of Florida to find an effective and affordable alternative to paper mulch would contribute the same production benefits as plastic mulch and in addition would reduce non-recyclable and non-renewable waste. In their study they used end rolls of 26 lb. kraft paper, coated with polymerized vegetable oil, black polythene film and control were the treatments. Result revealed that watermelon grown on paper mulch coated with polymerized vegetable oil yielded on par with black plastic mulch.

Shrivasthava *et al.* (1999) conducted an experiment to study the effect of drip, mulches and irrigation levels on tomato yield. The treatments comprised various combinations of two irrigation methods namely, drip and surface flood, with and without two mulches of either black plastic or sugarcane trash. For drip, three irrigation levels viz. 0.4, 0.6 and 0.8 fractions of pan evaporation (PE) were tried. This study revealed that drip plus sugarcane trash mulch scheduled at 0.4 PE level was the best combination, which gave the highest fruit yield of about 51 MT/ ha with 44% water saving. The highest yield of 163 kg/ha/mm of water used was also maximum in this treatment.

An investigation was conducted by Ghosh *et al.* (2007) to study the effect of different mulches on yield and physico-chemical properties of ber fruits. The results showed that mulching treatments significantly conserved higher moisture in soil. The hoeing around the plant basin followed by organic mulching and white polyethylene resulted highest soil moisture status of 6.8% and maximum fruit retention of 70% and yield of 15 kg/plant. The fruit quality was superior under organic mulches with maximum net return of Rs. 185/plant which was higher by Rs. 95/plant as compared to control.

Dinesh *et al.* (2008) conducted a field experiment during 2003-04 and 2004-05 to assess the effect of different types of organic mulches on growth, yield and soil moisture in turmeric grown as inter crop in mango orchard under rain fed conditions in eastern India. Five treatments viz, paddy straw mulch (1kg/cm²), paddy straw mulch (0.5 kg/cm²), local grass mulch (1 kg/cm²), local grass mulch (0.5 kg/cm²) and control (no mulching) were replicated four times in a randomized block design. The results indicated that effective production was recorded with the application of paddy straw mulch at 1kg/cm². The soil moisture content was higher during rhizome formation, development and maturation stage in plots where paddy straw was applied at 1 kg/cm².

Anzalone *et al.* (2010) carried out a three years of field trials using different biodegradable mulch materials in tomato in Zaragoza, Spain. The aim was to evaluate weed control with several biodegradable mulches as alternatives to black polyethylene (PE) mulch. The treatments were rice straw, barley straw, maize harvest residue, absinth wormwood plants, black biodegradable plastic, brown kraft paper, PE, herbicide, manual weeding, and unweeded control. The best organic mulch was rice straw and the worst weed control was from absinth wormwood. Tomato yield was highest for PE followed by paper, manual weeding, biodegradable plastic, and rice straw and was clearly related to weed control. Paper, biodegradable plastic, and rice straw are potential substitutes for PE and herbicides.

Berihun (2011) conducted an experiment to evaluate the effect of mulch and amount of water on the yield of tomato under drip irrigation system. A factorial combination of three levels of water (namely 315, 440 and 565 mm) combined with three mulch treatments [namely without mulch (WM), black plastic mulch (PM) and straw or crop residue mulch (STM)] amid three replications and two days irrigation interval was used. The application of 440 mm/ha water in two days interval with straw mulch is found to be economically and agronomically feasible.

2.4.2 Effect of synthetic mulch

According to Emmert *et al.* (1969) black plastic mulch was exceptionally good for early planting of vegetables. Bhattacharya *et al.* (1985) reported beneficial responses like early maturity and higher yield by using polythene mulches.

Free *et al.* (1990) reported that grain yields of shelled corn over a 3 year period of corn hybrids, Cornell M-10 and Robson 350, were increased by 1456 and 896 lb/acre, respectively, by the use of slit translucent plastic covers on the field as mulch. They also reported that, when the plastic cover was no slit, but was sealed to the stalks to suppress evaporation and to prevent the entrance of rain, yields were at or above 5600 lb/acre, and were consistently higher than the yields of unmulched plots.

Himelrick *et al.* (1993) conducted an experiment to find out the effect of mulch type in annual hill strawberry. The control treatments were bare ground and plastic mulch treatments were clear plastic, black, black on white, white on black. Total yields with all mulches except white on black were significantly higher than the control.

Taber *et al.* (1993) reported that plastic mulch and cover treatments increased total and early yield of musk melon compared with bare soil. Sikhamany *et al.* (1993) found that vine yields were highest with polythene mulch followed by straw mulch and no mulch.

Castilla *et al.* (1994) studied influence of soil mulching with polyethylene film on garlic. Single and double garlic rows mulched with polyethylene film were compared with bare soil. Yields of fresh green plants were significantly higher in the mulched treatment. The final garlic yields were similar in the single row mulched and control treatments, but significantly higher in the double row mulched treatments than control treatments.

According to Gutal *et al.* (1994) the use of plastics in agriculture helped to increase the production per unit area for all types of crops. Based on 3 years data they concluded that 25 micron black LDPE film had a significant effect on the growth and yield of crops, increasing yield by 55% compared to the control treatment.

An experiment was conducted by Srinivas *et al.* (1994) to find out the effect of different mulches and cover crops on water relation, yield and water use of Robusta banana. Two mulches (rice straw and black polythene); four cover crops and a control (no mulch and cover crops) were the treatments. Polythene as well as straw mulch significantly increased the plant height and girth. Fruit yield of banana was higher under polythene mulch than under cover-cropped banana and banana without cover crop and mulch. The yield increases with polythene mulch was 19% and straw mulch 11%.

In an experiment conducted by Quadir *et al.* (1995) seedlings of water melon were mulched with straw, clear polyethylene film or black polyethylene film. Control plants were not mulched. Marketable fruit yield per plant was significantly improved by mulching, polyethylene being more effective than straw.

Lourduraj *et al.* (1996) conducted field experiments for four years on bhindi and for two years on tomato at Tamil Nadu Agricultural University, Coimbatore. Results revealed the beneficial effects of mulching. In case of tomato, mulching with black LDPE recorded yield of 12,735 kg/ha, thus registering 28.4% higher yield over

unmulched control. In bhindi, mulching with black LDPE resulted in 50% yield increase compared with control.

In the field trials conducted by Farghale *et al.* (1997) aubergine plants grown on a clay soil were mulched with black or white polyethylene sheets applied before planting. Compared with controls, mulching resulted in earlier flowering and fruiting, increased plant height and greater number of branches. Average early yield and total yield was more in mulched plots compared to control plots.

Farias *et al.* (1997) conducted field studies in south western Mexico to determine the effect of three colours of plastic mulch (black, white, and clear) on aphid populations, soil temperature, and on fruit yield of watermelon (*Citrullus vulgaris* Schard.). Fruit length was increased with clear and white plastic. Plants grown on clear plastic mulch produced higher marketable yields than those grown on bare soil. Other colours (black and white mulches) were intermediate in their effects on aphid populations, soil temperature, fruit weight, and yield response. Marketable yields of 48.3, 43.2, 38.3, and 22.8 t/ha were achieved under clear, black, white, and unmulched soil treatments respectively. All plastic mulches increased fruit weight and total yield as compared with production on bare soil.

An experiment was conducted by Gilsha Bai (1997) to study the effect of drip irrigation along with two colours of plastic mulch on the growth and yield of summer season vegetable. Two types of irrigation methods, drip and surface, and two colours of plastic mulches, black and transparent were used. Mulches increased soil temperature. Higher soil temperature was developed under transparent mulch compared to black mulch. All treatments with black mulch increased the yield compared to the control. Most of the treatments with transparent mulch reduced the yield. This reduction in yield is due to the high soil temperature developed under the transparent mulch. Yield was increased with the soil temperature upto an optimal level of about 46⁰C and then decreased with further increase in soil temperature.

Studies by Faris *et al.* (1998) on cucumber showed that fruit number and yield were higher for mulched plots. Mulching reduced the number of days to flowering and first harvest.

MATERIALS AND METHODS

CHAPTER 3

MATERIALS AND METHODS

This chapter gives the description of various materials used and the methodology adopted for achieving the objectives of the study. The hydraulic studies and the field performance evaluation of the micro sprinkler on crop performance were conducted during July 2011 to February 2012.

3.1 Study area

The hydraulic performance of the micro sprinkler was evaluated in the Soil and Water Engineering Laboratory and its field performance at the instructional farm of Kelappaji College of Agricultural Engineering and Technology (KCAET), Tavanur, Malappuram, Kerala, India. Geographical reference of the study area is $10^{\circ} 51' 18''$ N latitude and $75^{\circ} 59' 11''$ E longitude. The soil type of the experimental plot was sandy loam. Average annual rainfall of the area is 300 cm. About 75% of the annual rainfall is received through South West monsoon and the balance 25% by North East Monsoon. Climate is humid tropic with a mean annual maximum temperature of 30°C and relative humidity 75%.

3.2 Description of the Farmer Developed Micro Sprinkler (FDMS)

The micro sprinkler used for the hydraulic and field performance evaluation was developed by a farmer named 'Avaran' hailing from Malappuram District of Kerala State, India. It is made from Low Density Poly Ethylene (LDPE) 3 mm diameter micro tube. The method of construction of micro sprinkler is simple. It is formed by fusing one end of the micro tube, an L shaped bend is formed near the fused end, at the outer side of this bend a small cut is given having length 4 mm and width ranging from 0.5 mm to 2 mm size by a sharp knife. The discharge rate of these micro sprinklers varies from 20 lph to 90 lph at the nominal operating pressures of 1 kg/cm^2 to 2 kg/cm^2 producing quarter circle jets of 1 to 3 m diameter. As this micro

sprinkler is manually made with indigenous techniques, there exists a large variation in the dimensions of cut from one sample to another.



Plate 3.1 Micro sprinkler developed by the farmer

3.3 Hydraulic performance of the FDMS

The experimental set up consisted of a sump, a centrifugal electric pump (1 hp, 20 m of total head), filter, pressure gauge (0-7 kg/cm²), main pipe and lateral with micro sprinkler. The main line was 40 mm diameter PVC pipe and the lateral by 16 mm diameter LDPE. Two gate valves were connected, one to the suction and the other to the delivery line to control the discharge from the pump. The catch cans of 13 cm diameter and 14 cm height were placed at 30 cm grid intervals in a matrix extending to a radius of 270 cm from the micro sprinkler.

3.3.1 Discharge

The discharge of the micro sprinkler was collected for a specified time interval in a collecting vessel and its volume was measured to get the nozzle discharge. The micro sprinkler connected to the lateral was mounted on a platform and the collecting vessel was placed beneath the micro sprinkler. A small plastic jar

was placed over the micro sprinkler without disturbing the operation, to confine and direct the stream ejected from the micro sprinkler to the collecting vessel. The gate valve in the experimental set up was adjusted to maintain the required operating pressures, monitored by a pressure gauge. Time was noted by a stop watch and the volume of water collected in the vessel was measured by a measuring jar. The discharge rate was determined by dividing the volume of water collected by the corresponding time.

The procedure was repeated for different samples of the same nozzle size, four different nozzle sizes and different operating pressures. The functional relationship (pressure Vs discharge) of the micro sprinkler was established by plotting the flow rate against the operating pressure. Further, the variability of discharge within same sized micro sprinklers were plotted and their COVs were determined.

3.3.2 Wetted radius

The wetted radius (R) is defined as the distance measured from the emitter location to the farthest point at which the emitter delivers water at a minimum rate of 0.26 mm/hr. The wetted radius was taken as the average distance from the micro sprinkler to the most distant catch cans which received water as per the above criterion.

3.3.3 Mean application depth

The mean application depth (D_a) can be calculated by averaging the depths of water caught in the cans located within the wetted radius from the emitter. It can also be computed from the volume of water applied and the area over which water is being sprayed.



Plate 3. 2 Discharge measurement



Plate 3. 3 Pressure gauge



Plate 3. 4 Test set up of micro sprinkler: pump, pipe and control valves

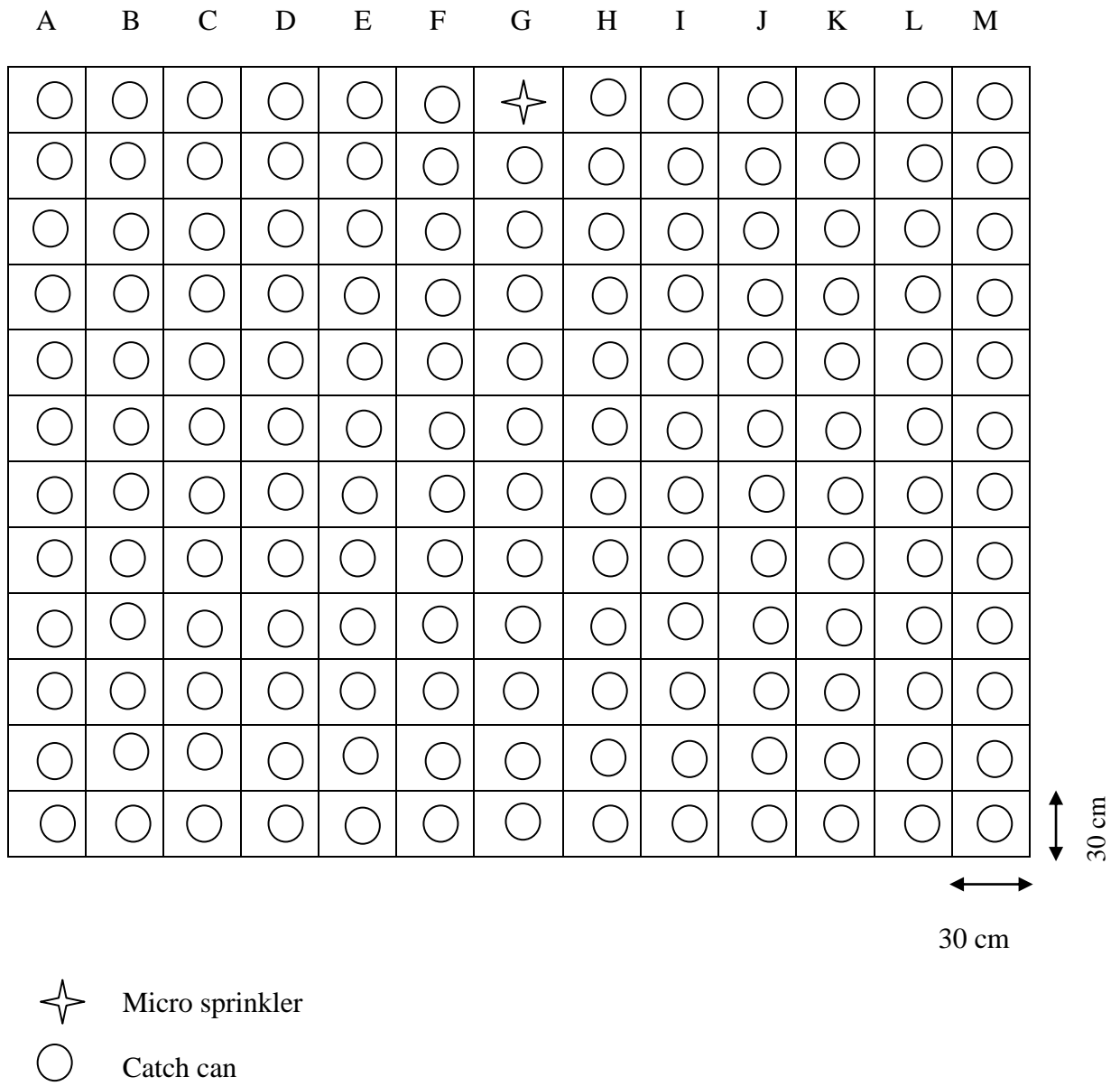

Fig. 3. 1 Placement of catch cans over the grid



Plate 3.5 Micro sprinkler with lateral

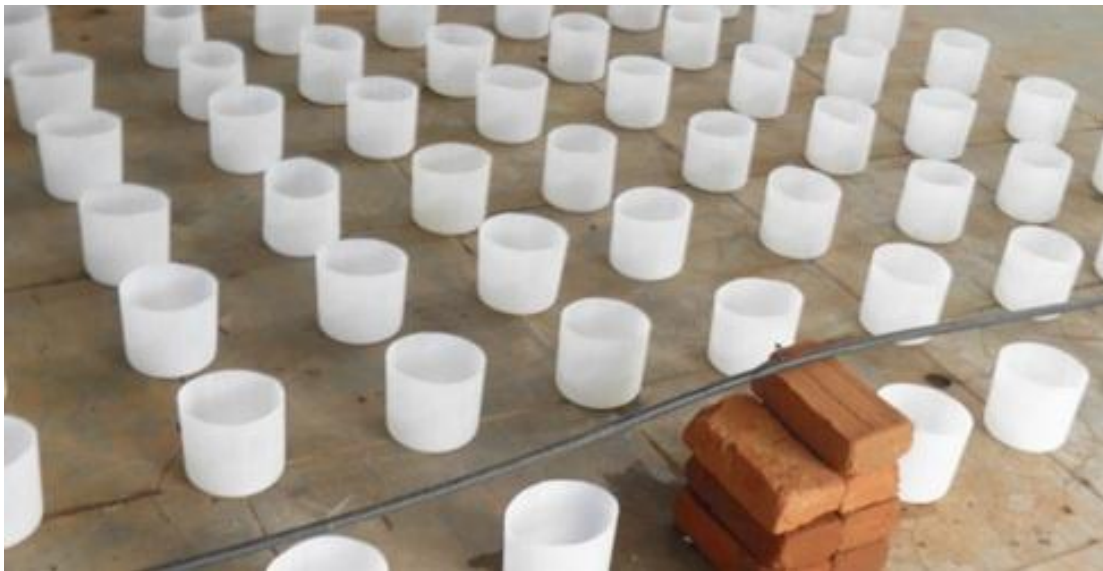

Plate 3. 6 Uniformity test using catch cans

3.4 Uniformity of application

The various performance indices of the micro sprinkler viz. coefficient of uniformity, coefficient of variation and distribution characteristics which are used to describe the uniformity of application of the emitters were calculated and the distribution patterns were plotted to get a proper knowledge on the water distribution by the emitters (Jenson, 1983).

3.4.1 Christiansen Uniformity Coefficient

One of the popular measures of determining the uniformity of water distribution of sprinklers is Christiansen Uniformity Coefficient (Christiansen, 1942). The Christiansen's uniformity coefficient (CUC) is calculated as

$$\text{CUC} = \left(1 - \frac{\sum x}{mn} \right) \times 100 \text{ where,}$$

CUC = Christiansen's uniformity coefficient (%)

m = Average value of all observations, mm

n = Total number of observation points

x = Numerical deviation of individual observations from the average application rate, mm

3.4.2 Coefficient of variation

The performance of micro sprinklers could be studied by taking the coefficient of variation (COV) of catch depths (Boman, 1989). The coefficient of variation of the application depths for a particular emitter was calculated by dividing the standard deviation of the application depths by the mean application depth, expressed as a percentage.

$$\text{Coefficient of variation (COV)} = \frac{D_{sd}}{D_a} \times 100 \text{ where}$$

D_{sd} = Standard deviation of application depth

$$D_{sd} = \sqrt{\frac{(D_i - D_a)^2}{N}}$$

Where, D_a = Average application depth

D_i = Individual application depth

N = Total number of application depths used to calculate the mean

3.4.3 Distribution characteristic

‘Merriam and Keller’s distribution characteristic (DC) was defined as the ratio of the area which receives more than half of the average application depth to the total wetted area, expressed as a percentage. The coefficient was also calculated as the ratio of the number of individual application depths greater than half of the mean application depth (i.e. $> D_a/2$) to the total number of the individual application depths (Merriam and Keller, 1978).

$$DC = \frac{\text{Area receiving more than half of the mean application depth}}{\text{Total wetted area}}$$

3.5 Water distribution pattern

The can catches were used to plot the moisture distribution pattern corresponding to the spray coverage of the emitters. The amount of water collected in each catch can was expressed as a percentage of the mean application depth, D_a . The computer software ‘SURFER’ was used to plot the curves by connecting the interpolated points of equal collection (application) rates. The software fills the area between the contour lines, the isograms, connecting points of equal collection rates according to the levels specified. Thus the contour lines and the filled area together formed the distribution pattern.

3.6 Manufacture of standardised micro sprinkler

To develop standardized micro sprinklers of various dimensions, plastic injection moulding was used. Plastic injection moulding is the process of using molten plastic and an injection mold machine to create molded plastic products. It is used for both thermoplastic and thermosetting plastic materials. Here, the material is fed into a heated barrel, mixed, and forced into a mold cavity where it cools and hardens to the configuration of the mold cavity. After a product is designed, usually by an engineer, moulds are made by a mould maker (or toolmaker) in metal, usually either steel or aluminum, and precision machined to form the features of the desired part.

3.7 Field performance of the Farmer Developed Micro Sprinkler (FDMS)

3.7.1 Crop and variety

A vegetable crop cucumber has been used in this study for evaluating the field performance of the micro sprinkler. It is one of the most popular vegetable crops of Kerala, grown in tropical and sub tropical regions for its tender green fruits. Hence, this crop was selected and the variety was *Saubhagya*. Recommended crop spacing is 50 x 50 cm with a root zone depth of 45 cm. The total duration of the crop was 120 days.

3.7.2 Land preparation

The field was prepared by a tractor drawn rotovator. Land leveling and digging of plots was done manually.

3.7.3 Experiment design

The layout of the experimental plot is shown in figure 3.2. The various treatments are marked. The experiment was laid out in a Randomized Complete Block Design with 9 treatments and 3 replications. The treatments selected for the study are:

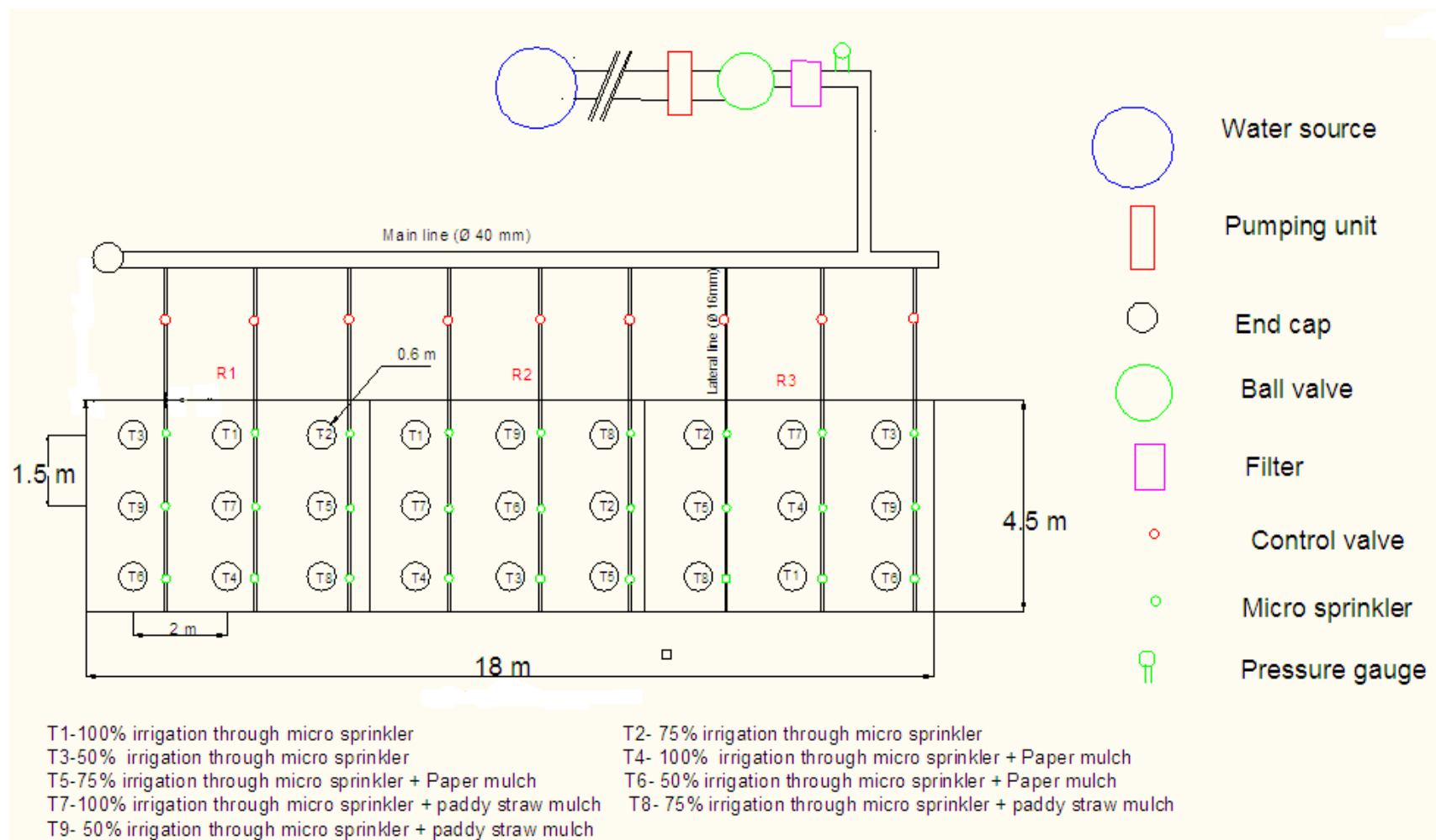

Fig. 3.2 Layout of the field experiment

Treatment 1 (T₁): 100% irrigation through micro sprinkler

Treatment 2 (T₂): 75% irrigation through micro sprinkler

Treatment 3 (T₃): 50% irrigation through micro sprinkler

Treatment 4 (T₄): 100% irrigation through micro sprinkler + paper mulch

Treatment 5 (T₅): 75% irrigation through micro sprinkler + paper mulch

Treatment 6 (T₆): 50% irrigation through micro sprinkler + paper mulch

Treatment 7 (T₇): 100% irrigation through micro sprinkler + paddy straw mulch

Treatment 8 (T₈): 75% irrigation through micro sprinkler + paddy straw mulch

Treatment 9 (T₉): 50% irrigation through micro sprinkler + paddy straw mulch

The experimental field was irrigated uniformly with the locally developed micro sprinkler.

3.7.4 Installation of micro sprinkler

Field was prepared and the locally developed micro sprinkler system was installed in the field. The discharge rate of micro sprinkler selected for the study having 1mm wide nozzle size was between 50-60 lph at 1 kg/cm². There were nine laterals in the system. Each lateral was laid along breadthwise for applying equal level of irrigation. One sprinkler serves one pit taken for raising the plant. Each lateral is fitted with three such sprinklers to supply water for twenty seven pits.

3.7.5 Mulching, sowing and agronomic practices

Position of each treatment plot was marked in the layout. Farm Yard Manure (FYM) was mixed with the top soil of the pit. Two different mulching materials viz. paddy straw at the rate of 1 kg/m² and news print paper of 80 GSM were spread on the treatment plots. The edges of the news print sheets were covered by soil to prevent blowing off by wind. For sowing the seeds, small holes were made in the case of newsprint paper mulch and five seeds were sown in a pit. The unhealthy plants were removed after two weeks and only three plants were retained per pit.

Manure and chemical fertilizers were applied in the soil as per the Package of Practices Recommendations of KAU. Fertilizers were fully applied as basal dose,

because spreading of the mulch material prevents split application. The weeding and raking of the soil were done at the time of fertilizer application.

3.7.6 Estimation of crop water requirement

Water requirement of crops is a function of plants, surface area covered by the plants and evaporation rate. The maximum discharge required during any one of the three seasons is adopted for the design. The daily water requirement for fully grown plants was calculated as under.

$$V_m = K_c \times K_p \times C_c \times E_p \times A$$

In which,

V_m = Monthly irrigation water requirement, L

K_c = Crop coefficient

C_c = Canopy factor ($C_c = 1.0$ for closely spaced field crop, $C_c =$ wetted area/plant area for orchards and vegetable crops)

K_p = Pan evaporation factor (generally 0.7)

E_p = Normal monthly pan evaporation, mm

A = Area to be irrigated, m^2

3.7.7 Scheduling of irrigation

As the shoots were so short during the seedling stage manual watering was done for a period of one week to ensure that the roots get enough water to survive. The discharge rate of the micro sprinklers selected for the field study was varying between 50-60 lph at 1 kg/cm^2 . Hence, daily irrigation was applied for a time period of 24 minutes to obtain the required amount of water.

3.8 Observations for evaluating field performance of the micro sprinkler

Observations required for evaluating field performance of the micro sprinkler were soil moisture distribution, temperature variation in the field, number of female flowers, yield and fruit characteristics.

3.8.1 Effect of micro sprinkler treatments on soil moisture distribution

The soil moisture content at the surface and at 30cm depth in the root zone was determined in each plot one hour after irrigation by gravimetric method. The soil samples were taken from the centre and four diagonally opposite corners from the circular basin of the plant. The soil samples taken from surface and at 30 cm depth were collected in air tight aluminum containers. The samples were weighed and oven dried at 105⁰C for 24 h, until all the moisture dried out. After removing from the oven they are cooled slowly to room temperature and weighed again. The difference in the weight is the amount of moisture in the soil. The percentage of moisture content was determined by gravimetric method.

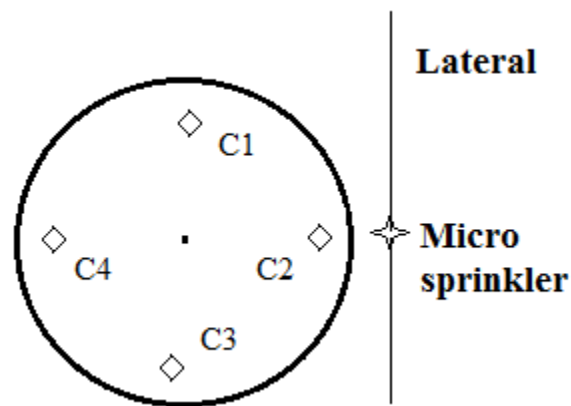

Fig. 3.3 Moisture content determination

3.8.2 Effect of micro sprinkler treatments on soil temperature

Soil temperature was measured at 5 cm depth from the soil surface using a soil thermometer. The measurement was taken at 2.30 pm, at a time when the soil is expected to attain maximum temperature of the day.

3.8.3 Effect of micro sprinkler treatments on yield

The harvest of the crop started 45 days after sowing. Harvesting was done weekly from all the plots. The weight of fruits harvested from each plot was recorded separately.

3.8.4 Effect of micro sprinkler treatments on fruit characteristics

After harvesting of the crop, observations on Fruit length, weight and girth was measured.

3.8.5 Effect of micro sprinkler treatments on water use efficiency

Water use efficiency was calculated as the ratio of the crop yield in kg/ha to the cumulative depth of water applied in mm.

ie., $E_w = Y/W_u$ where,

E_w = Water use efficiency (kg/ha/ mm)

Y = Yield of the crop in kg/ha

W_u = Total water applied, mm

3.9 Statistical analysis of the data

Data collected from the field experiment was analysed statistically by the computer software MSTAT. Analysis of variance has been done to analyse the total variation of the data into components which may be distributed to various “sources” or ‘causes’ of variation. Its purpose is to test the significance of the differences among sample means.

RESULTS AND DISCUSSIONS

CHAPTER 4

RESULTS AND DISCUSSION

The findings from experiments conducted on hydraulic and field performance of the micro sprinklers under study are presented in this chapter.

4.1 Hydraulic performance of the Farmer Developed Micro Sprinkler (FDMS)

The hydraulic performance of the micro sprinkler was evaluated in terms of discharge, wetted radius, water application depth, water distribution pattern and uniformity of application are given in the forthcoming sections.

4.1.1 Discharge

The discharge of the four different sized FDMS tested under four different operating pressures are presented in and fig. 4.1. The mean discharge of the 0.5 mm wide cut micro sprinkler (WCMS) was 30.6 lph at 0.5 kg/cm² operating pressure. Mean discharge of the MS for other operating pressures of 1, 1.5 and 2 kg/cm² are respectively 39.2, 47.0 and 53.7 lph. Corresponding discharge values in the case of 1 mm WCMS were 39.0, 48.5, 59.9 and 68.1 lph respectively for the same variations of operating pressures. Discharge values were 44.5, 60.2, 67.3 and 75.6 lph for 1.5 mm WCMS. In respect of 2 mm WCMS, the mean discharge values varied through 45.8, 60.0, 74.1 and 90.1 lph for the four different operating pressures (Jadhav *et al.* 2011).

Operating pressure versus discharge curve as presented in fig. 4.1 shows non linear trend for all the four different micro sprinkler sizes and the best fitted equation with RMS errors is shown against each. The variability of discharge within the same size sprinklers was considerable for all the four different sized sprinklers under study (fig. 4.2, 4.3, 4.4 and 4.5). It can be revealed by the high COV values of 11.7, 19.3, 13.5 and 14.1% for 0.5, 1.0, 1.5 and 2.0 mm WCMS respectively. This variability can be attributed to the non standard method of giving incision to the micro sprinkler head. The variability of discharge will be a serious set back as it will lead to non uniform application of water and the associated inefficiencies.

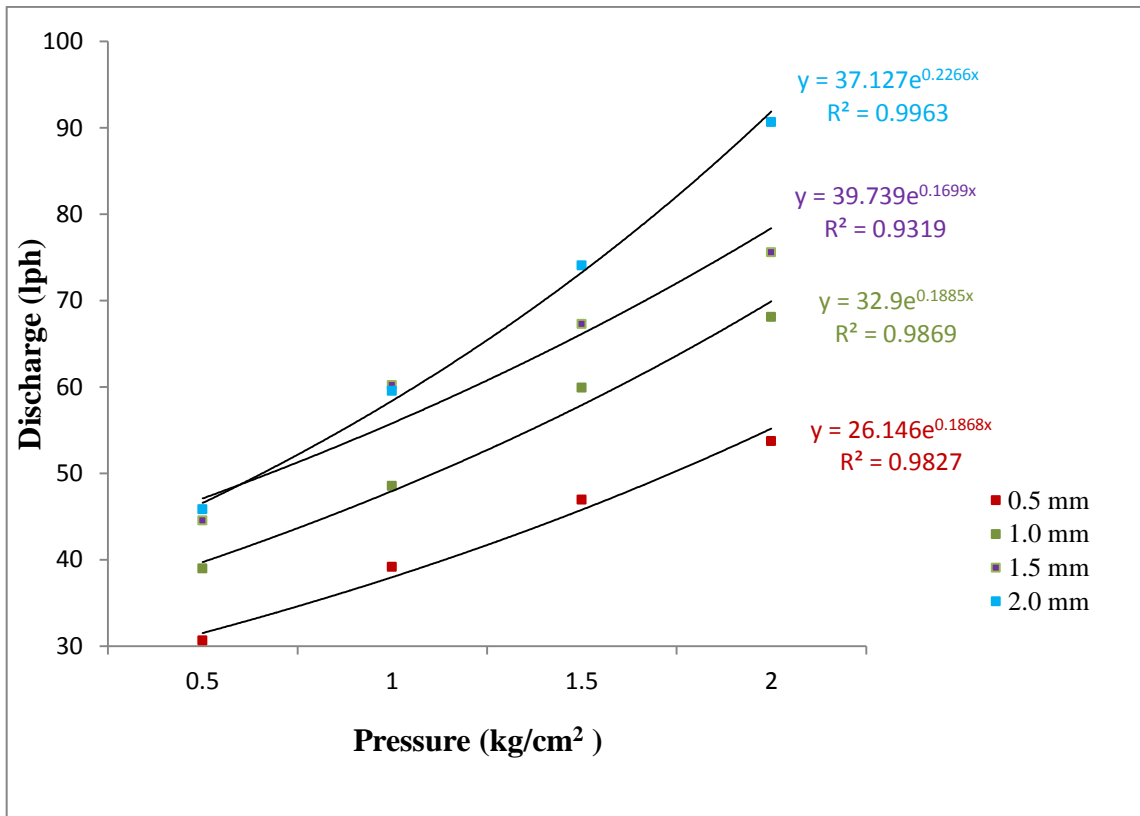

Fig. 4.1 Mean discharge of the FDMS at various operating pressures

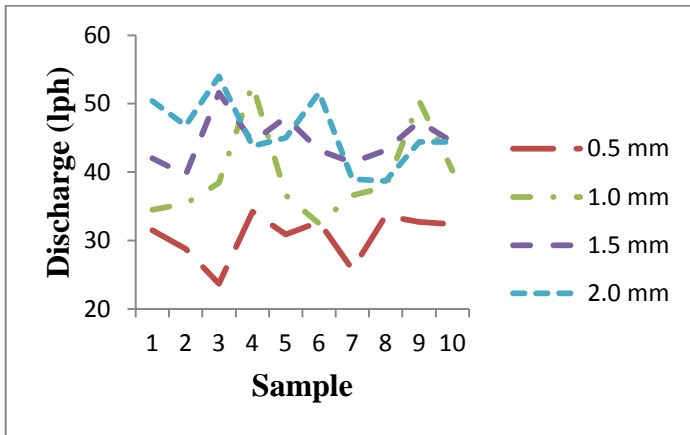

Fig. 4.2 Discharge of FDMS at 0.5 kg/cm²

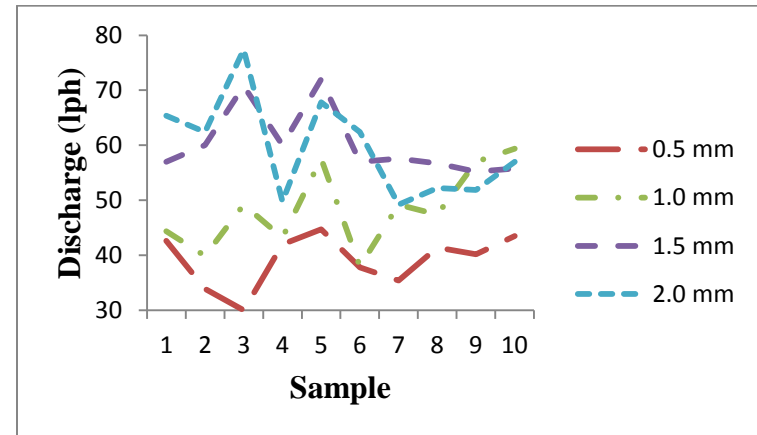

Fig. 4.3 Discharge of FDMS at 1.0 kg/cm²

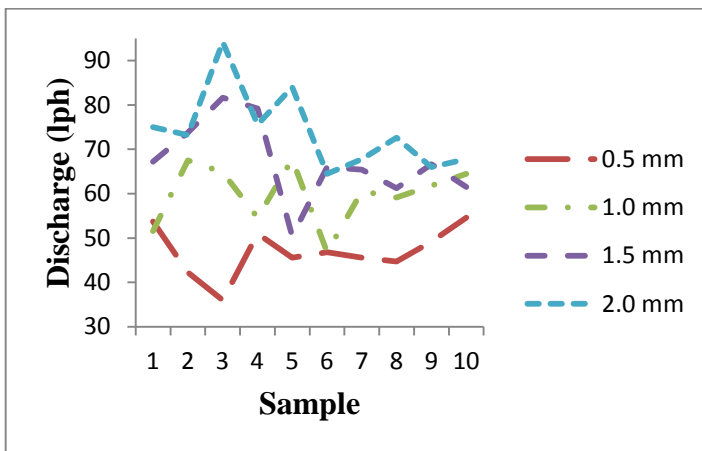

Fig. 4.4 Discharge of FDMS at 1.5 kg/cm²

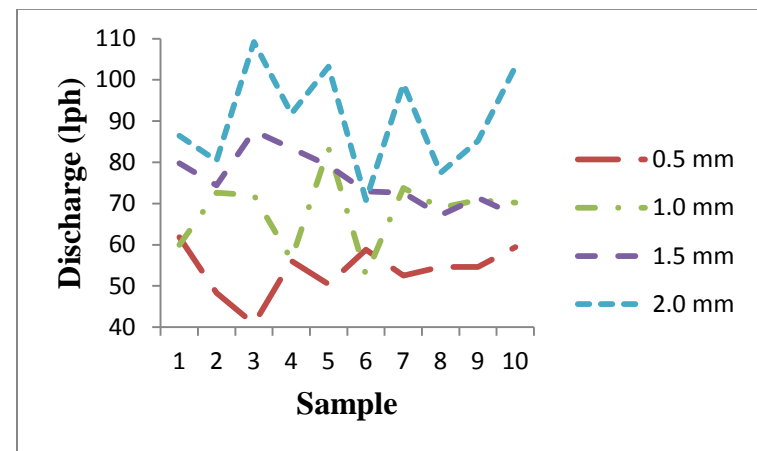

Fig. 4.5 Discharge of FDMS at 2.0 kg/cm²

4.1.2 Wetted radius

The wetted radius was calculated as the distance measured from the emitter location to the farthest point at which the emitter supplies water at a minimum rate of 0.26 mm/h. Wetted radius of the FDMS for various operating pressures are shown in figure 4.6. The mean wetted radius for 0.5 mm wide cut sprinkler at 0.5 kg/cm² is 2.31 m. The corresponding values were 2.42, 2.46 and 2.51 m respectively for other operating pressures of 1, 1.5 and 2 kg/cm². Mean wetted radius for other sprinkler sizes falls between 2.0 m and 2.34 m for 1.0 mm WCMS, 2.27 m and 2.46 m for 1.5 mm WCMS and 2.32 and 2.6 for 2.0 mm WCMS. Variability of the wetted radius between samples of the same size sprinklers were significant with a COV of 13.9, 10.0, 7.0 and 10.0 % in the case of 0.5, 1.0, 1.5 and 2.0 mm WCMS respectively. Variability of wetted radius within same sized samples decreases as the width of cut of MS increases. The values of the wetted radius are suitable for many of the plantation crops viz. coconut, areca nut and for vegetable and fruit crops.

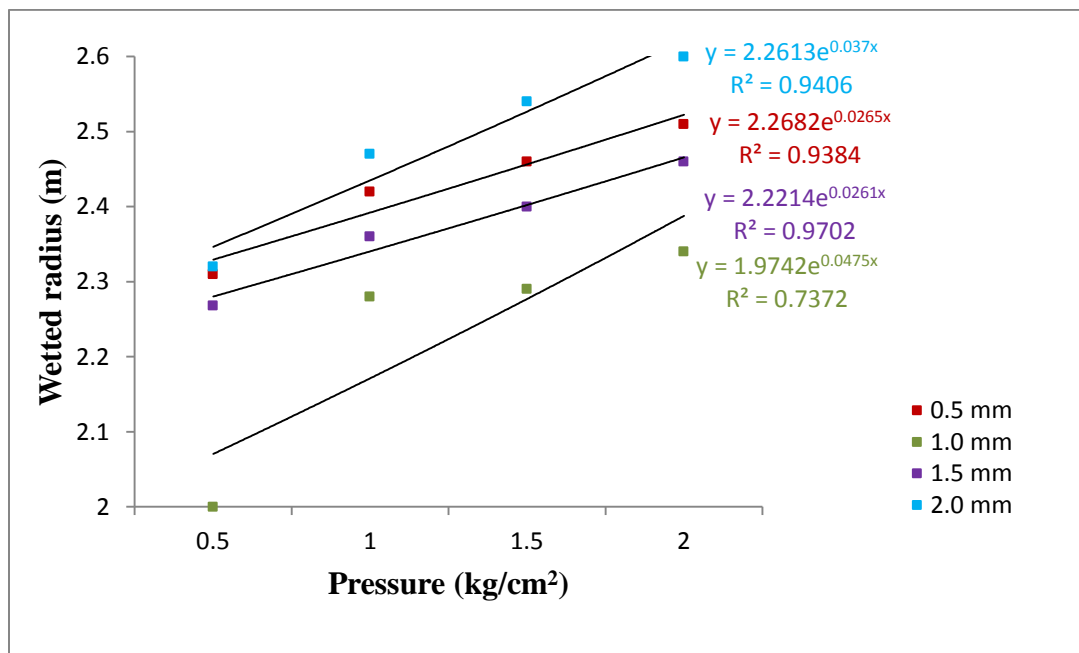

Fig. 4.6 Mean wetted radius of FDMS at different operating pressures

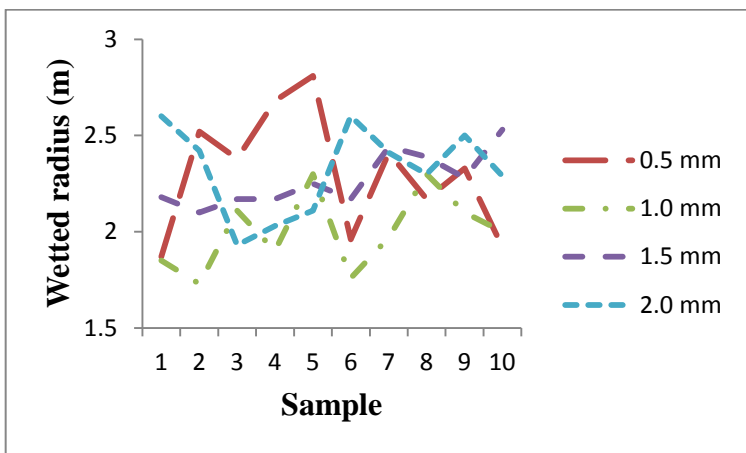

Fig. 4.7 Wetted radius of FDMS at 0.5 kg/cm²

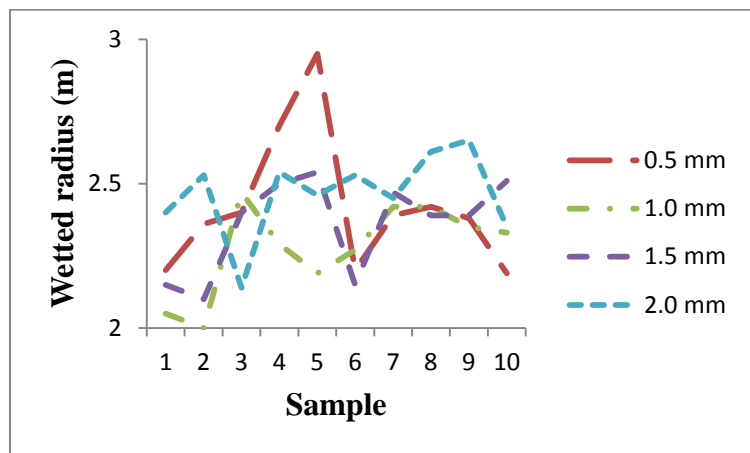

Fig. 4.8 Wetted radius of FDMS at 1.0 kg/cm²

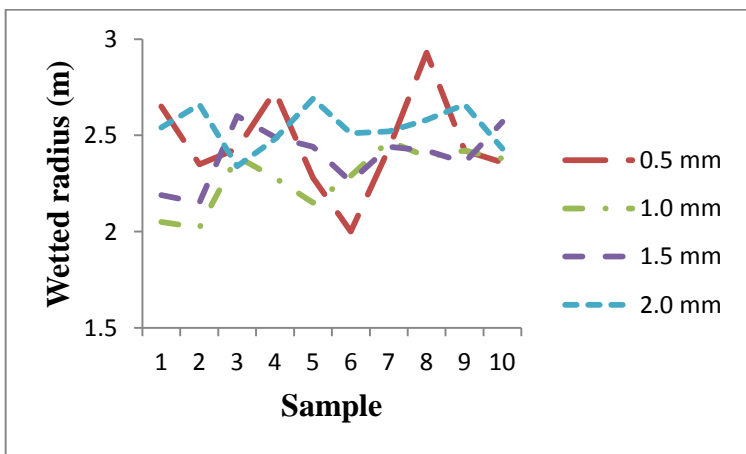

Fig. 4.9 Wetted radius of FDMS at 1.5 kg/cm²

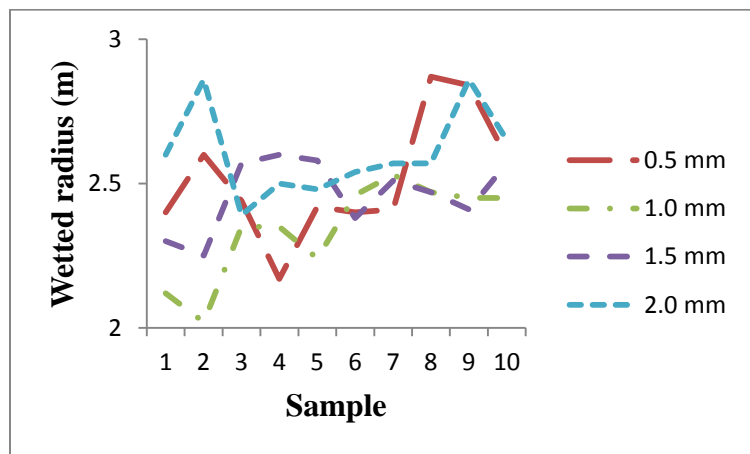

Fig. 4.10 Wetted radius of FDMS at 2.0 kg/cm²

4.1.3 Mean water application depth

The mean water application depth (D_a) of the FDMS and its variability is shown in and fig. 4.11. In the case of 0.5 mm WCMS mean water application depth vary from 7.8 to 11.1 mm/h corresponding to variation in operating pressure of 0.5 to 2.0 kg/cm². The corresponding variation is 12.0 to 16.1 mm/h for 1.0 mm WCMS. In the case of 1.5 mm and 2 mm WCMS, the application depth varies respectively from 11.1 to 15.9 mm/h and 11.2 to 17.3 mm/h corresponding to the above said pressure variation. The variation of application depth within same sized MS as indicated by COV is 33.5, 23.4, 18.6 and 28.2% for 0.5 mm, 1.0 mm, 1.5 mm and 2.0 mm WCMS. In all the cases the mean application depth are suitable for soils of moderate infiltration rate. The most ideal application depth appears to be the one given by 1.0 mm WCMS at 1.0 kg/cm². The highest mean application depth was 17.7 mm/h for 2.0 mm WCMS at 2.0 kg/cm² and the lowest mean application depth was 7.8 mm/h for 0.5 mm wide WCMS at 0.5 kg/cm².

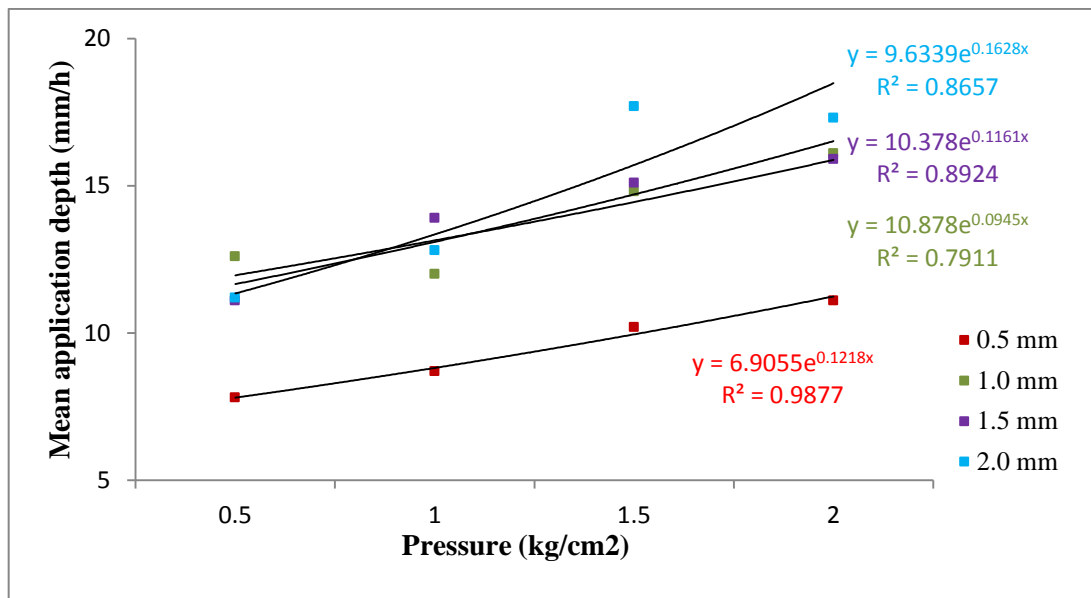

Fig. 4.11 Mean application depth of FDMS at various operating pressures

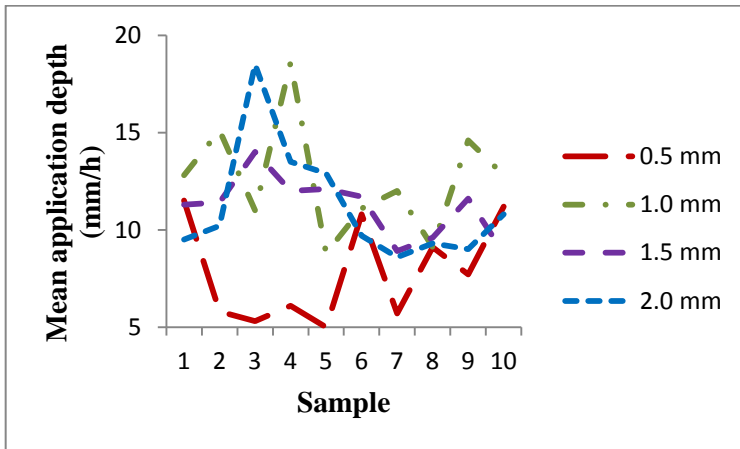

Fig. 4.12 Mean application depth of FDMS at 0.5 kg/cm²

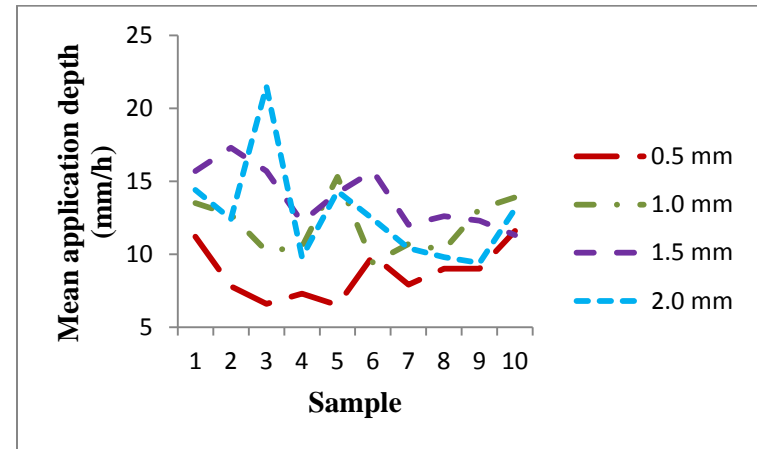

Fig. 4.13 Mean application depth of FDMS at 1.0 kg/cm²

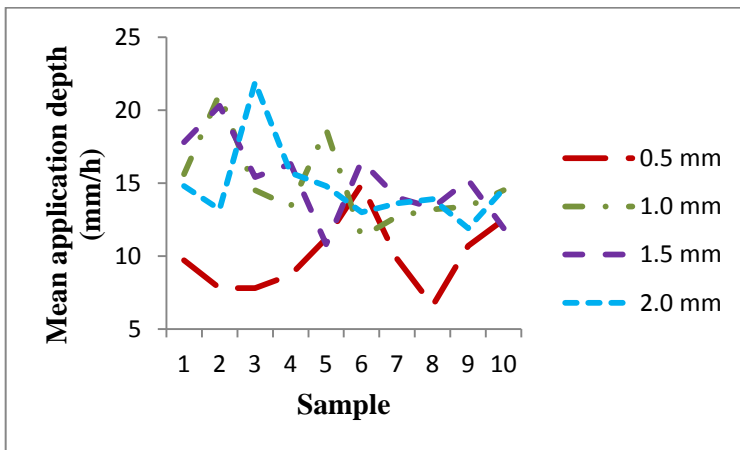

Fig. 4.14 Mean application depth of FDMS at 1.5 kg/cm²

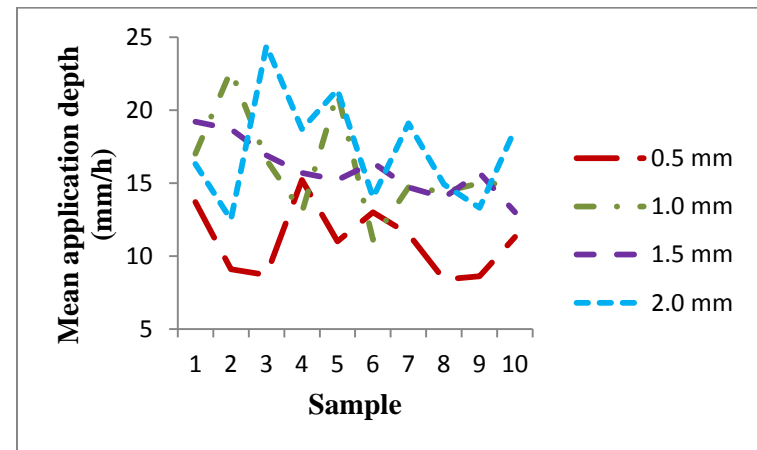

Fig. 4.15 Mean application depth of FDMS at 2.0 kg/cm²

4.1.4 Water distribution pattern

The water distribution pattern plotted with 'SURFER' software is presented in fig. 4.16 to 4.31 for various sized sprinklers at various operating pressures. The amount of water collected in each catch can was expressed as a percentage of the mean application depth, D_a . The software plotted the curves by connecting the interpolated points of equal collection (application) rates. The water distribution pattern plotted, by joining the points of equal application rate and shading the space between the isograms corresponding to the percentile proportion of the application rate, were analysed. The densograms gave a good visual impression of the nature of water distribution under the micro sprinklers.

The micro sprinkler with 0.5 mm wide cut at different operating pressures (Fig. 4.16, 4.17, 4.18 and 4.19) show a clear indication of poor performance. Although there is an increase in application depths, the distinct zones of higher application depth at central part of the wetted area shows high non-uniformity of application. Densograms justifies the low values of CUC and high values of COV (215.31% at 1 kg/cm²).

In the case of the micro sprinkler with 1.0 mm cut also, the application depth was not uniform at various operating pressures viz. 0.5, 1.0, 1.5 resulting in poor distribution pattern (Fig. 4.20, 4.21, 4.22 and 4.23), but this micro sprinkler at 2.0 kg/cm² showed a much better water distribution pattern.

The water distribution pattern of the micro sprinkler with 1.5 mm width of cut also showed an irregular pattern. Although DC values were high, the presence of considerable area with application depth at 0.5 and 1.0 kg/cm² reduces the uniformity (low values of CUC and high values of COV), but this micro sprinkler at 1.5 and 2.0 kg/cm² showed a moderate water distribution pattern (Fig. 4.24, 4.25, 4.26 and 4.27). The densograms of the micro sprinkler at 2.0 mm wide cut at 0.5, 1.0, 1.5 and 2.0 kg/cm² gives a better performance than 0.5 mm wide cut.

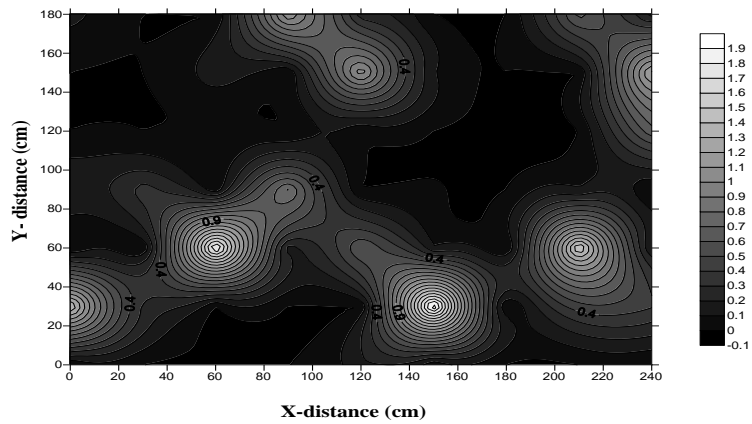

Fig. 4.16 Water distribution pattern of 0.5 mm wide cut FDMS at 0.5 kg/cm^2

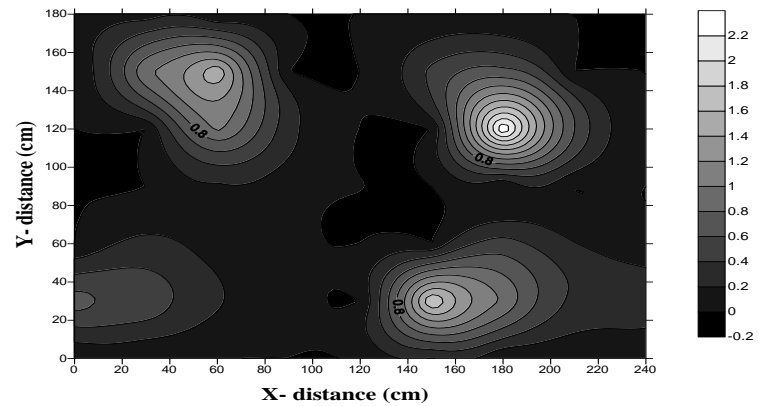

Fig. 4.17 Water distribution pattern of 0.5 mm wide cut FDMS at 1.0 kg/cm^2

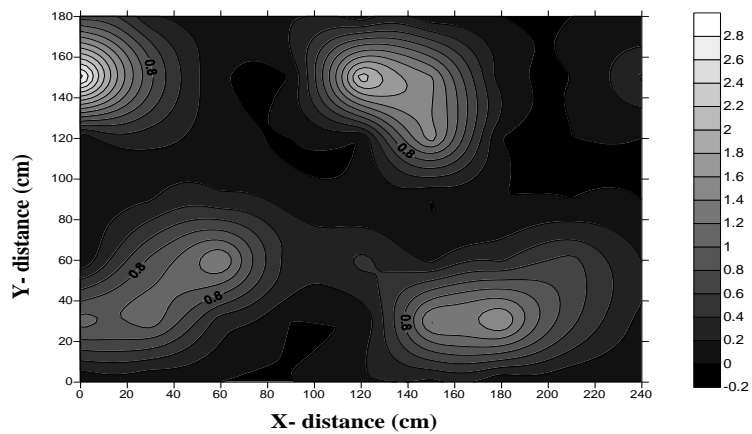

Fig. 4.18 Water distribution pattern of 0.5 mm wide cut FDMS at 1.5 kg/cm^2

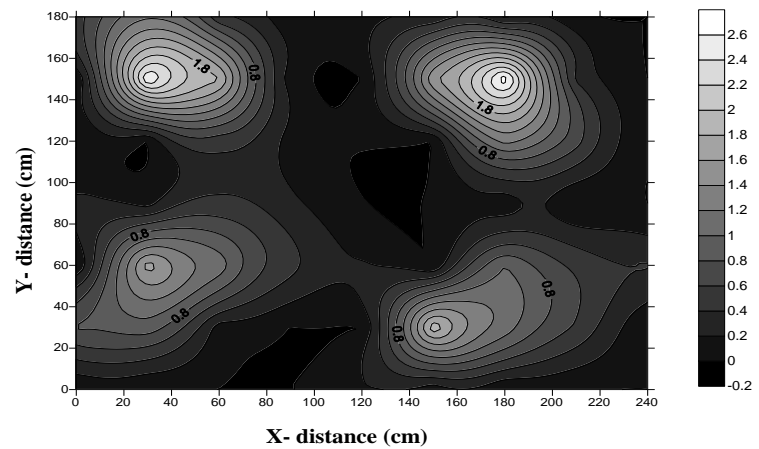

Fig. 4.19 Water distribution pattern of 0.5 mm wide cut FDMS at 2.0 kg/cm^2

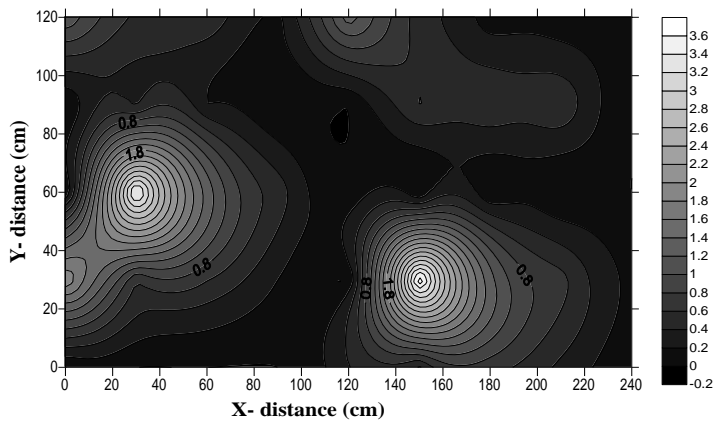

Fig. 4.20 Water distribution pattern of 1.0 mm wide cut FDMS at 0.5 kg/cm^2

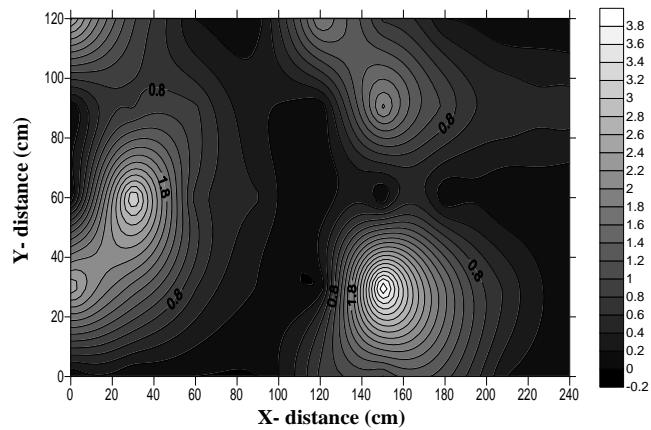

Fig. 4.21 Water distribution pattern of 1.0 mm wide cut FDMS at 1.0 kg/cm^2

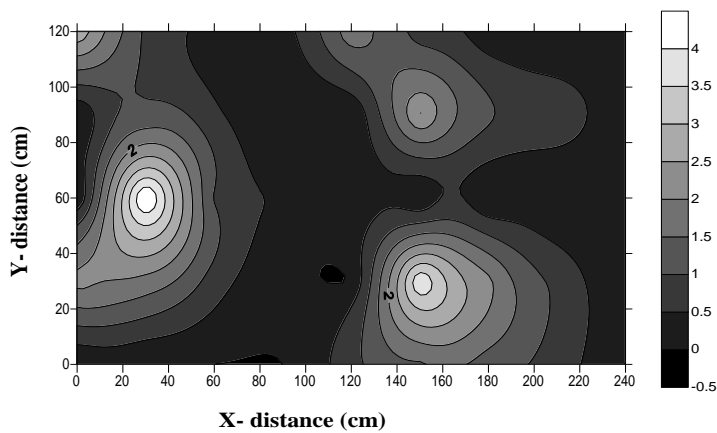

Fig. 4.22 Water distribution pattern of 1.0 mm wide cut FDMS at 1.5 kg/cm^2

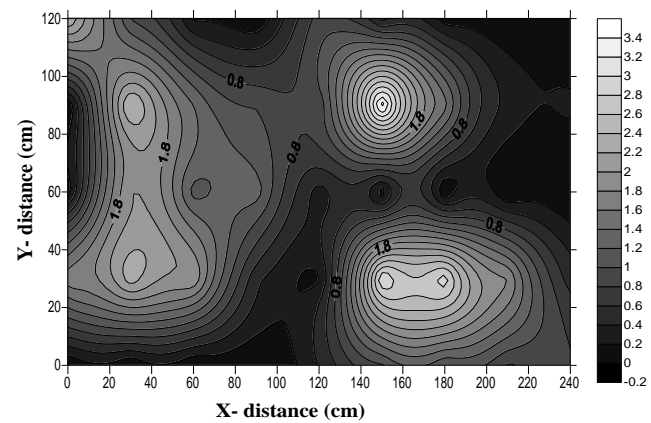

Fig. 4.23 Water distribution pattern of 1.0 mm wide cut FDMS at 2.0 kg/cm^2

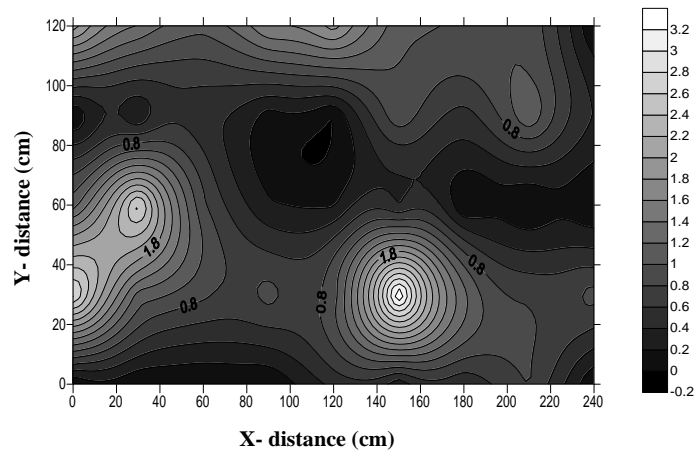

Fig. 4.24 Water distribution pattern of 1.5 mm wide cut FDMS at 0.5 kg/cm^2

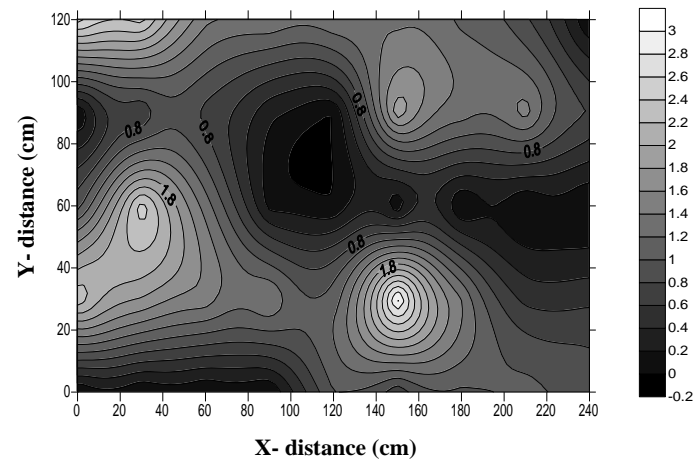

Fig. 4.25 Water distribution pattern of 1.5 mm wide cut FDMS at 1.0 kg/cm^2

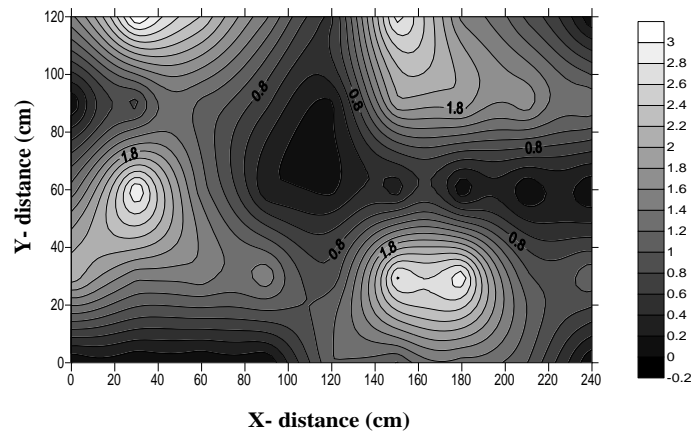

Fig. 4.26 Water distribution pattern of 1.5 mm wide cut FDMS at 1.5 kg/cm^2

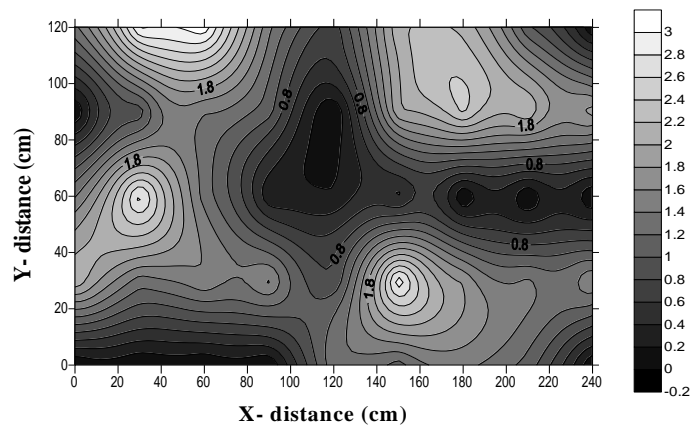

Fig. 4.27 Water distribution pattern of 1.5 mm wide cut FDMS at 2.0 kg/cm^2

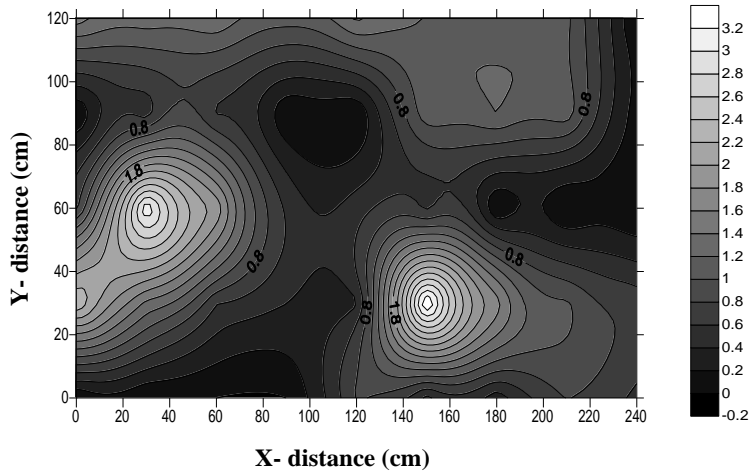

Fig. 4.28 Water distribution pattern of 2.0 mm wide cut FDMS at 0.5 kg/cm²

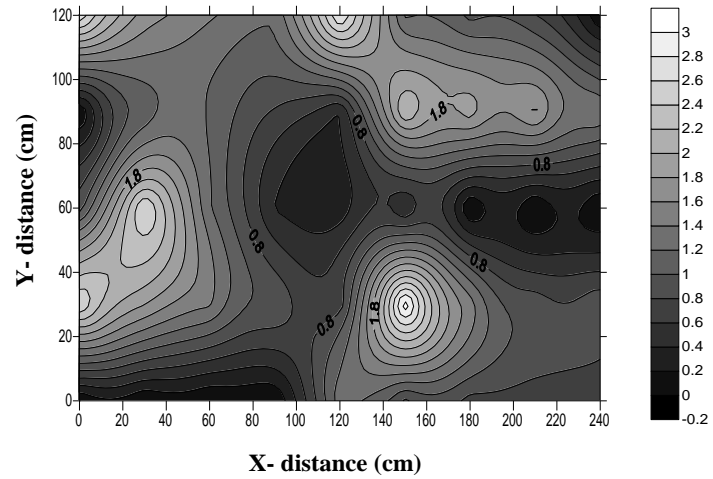

Fig. 4.29 Water distribution pattern of 2.0 mm wide cut FDMS at 1.0 kg/cm²

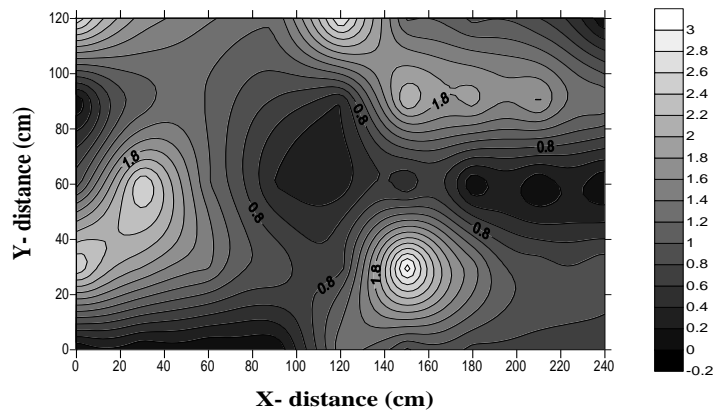

Fig. 4.30 Water distribution pattern of 2.0 mm wide cut FDMS at 1.5 kg/cm²

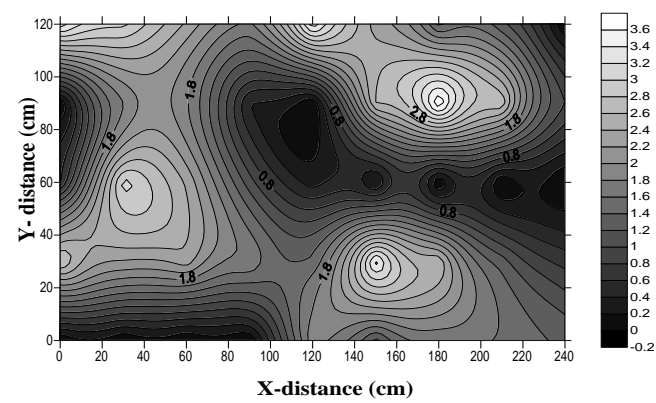

Fig. 4.31 Water distribution pattern of 2.0 mm wide cut FDMS at 2.0 kg/cm²

By analyzing the moisture distribution patterns of the micro sprinkler of different widths of cut it can be said that the performance of the micro sprinkler has been improved when the operating pressure is increased (the doughnut patterns disappeared and the whole pattern became more even and circular).

4.1.5 Uniformity of water application

Water application uniformity of the FDMS has been determined using different indices viz. Christiansen's Uniformity Coefficient, Coefficient of Variation and Distribution Characteristic.

4.1.5.1 Christiansen's Uniformity Coefficient (CUC)

The Christiansen's uniformity coefficient directly gives a measure of the uniformity of distribution of micro sprinklers. It is presented in table 4.1. It can be seen that CUC values range from 6.8 to 23.0% for the 0.5mm wide cut MS for an operating pressure of 0.5 kg/cm². For the same size of sprinkler, the range of CUC corresponding to operating pressures of 1.0, 1.5 and 2.0 kg/cm² were respectively 11.5 to 24.3%, 3.7 to 28.2% and 12.9 to 32.0%. In respect of other MS, the CUC varied from 6.3 to 35.3% for 1.0 mm wide cut, 3.7 to 32.0% for 1.5 mm wide cut and from 19.0 to 30.0 for 2.0 mm wide cut.

In general the values of uniformity coefficient are low in the case of single sprinkler operation. Usually high uniformity is achieved in the field by overlapping of sprinkler sprays. Most of the commercially available sprinkler heads, when operated as single sprinkler units, reported to have uniformity in the range of 30-35%. Hence the values obtained are satisfactory as far as a single sprinkler is concerned.

4.1.5.2. Coefficient of variation (COV)

Table 4.2 shows the values of Coefficient of variation (COV) of can catches for the tests conducted. The overall variation of COV is between 169.0 to 224.1% for 0.5 mm wide cut sprinklers, 111.2 to 210.2% for 1.0 mm wide cut sprinklers, 112.4 to 148.4% for 1.5 mm wide cut sprinklers and 98.47 to 167.6% for 2.0 mm wide cut

respectively for a range of operating pressure of 0.5 to 2.0 kg/cm². Since the coefficient of variation is the measure of the deviation of individual observation from the mean, higher values of COV represents poor distribution (large deviation from the average application depth) and lower values represents better performance. The micro sprinkler having coefficient of variation less than 100 per cent indicates “good” performance by that emitter, while COV values more than 200 per cent indicate poor water distribution efficiency and in between 100 per cent and 200 per cent indicate medium water distribution efficiency (Boman, 1989).

Based on the COV values, the best performance was for 2 mm wide cut micro sprinkler (98.47% at 2.0 kg/cm²). The lowest value of COV (215.31%) was for the MS with 0.5 mm wide cut at 1.0 kg/cm². Many other micro sprinklers have shown COV between 100% and 200%. The results further reveal that the micro sprinkler samples showed large variation in its performance due to non-standardised manufacturing process. The major reason leading to the above said variation is the manual cut given by the farmer for the sprinkler head. The discharge performance of the micro sprinkler necessitates the standardisation of the product.

4.1.5.3. Distribution characteristic

The Merriam and Keller’s distribution characteristic (DC) showed the percentile area receiving irrigation water at a rate, higher than half of the average application rate over the irrigated area. It was calculated as the ratio of the number of catch can that received more than half of the average application depth, to the total number of catch can placed over the wetted area.

The values of Distribution characteristic (DC) of the can catches are shown in table 4.3. The best performance was shown by the MS with 2.0 mm wide cut at 2.0 kg/cm² operating pressure (78.90%). The lowest DC obtained was 53.13% from 0.5 mm wide cut MS at 0.5 kg/cm². It is observed that about 80% of the total wetted area receives more than half of the mean application depth.

Table 4.1 Coefficient of uniformity of FDMS at various operating pressures

Emitter size		Pressure (kg/cm ²)	CUC (%)		Emitter size		Pressure (kg/cm ²)	CUC (%)	
l (mm)	b (mm)		S1	S2	l (mm)	b (mm)		S1	S2
4	0.5	0.5	5.2	41.8	4	1.5	0.5	6.8	23.0
		1.0	21.2	37.6			1.0	11.5	24.3
		1.5	4.8	32.7			1.5	3.7	28.2
		2.0	2.7	30.7			2.0	12.9	32.0
4	1.0	0.5	35.3	19.1	4	2.0	0.5	24.0	15.5
		1.0	14.0	10.2			1.0	19.0	19.0
		1.5	23.5	16.0			1.5	30.0	30.0
		2.0	6.3	14.4			2.0	26.8	26.8

Table 4.2 Coefficient of variation of FDMS at various operating pressures

Emitter size		Pressure (kg/cm ²)	COV (%)		Emitter size		Pressure (kg/cm ²)	COV (%)	
l (mm)	b (mm)		S1	S2	l (mm)	b (mm)		S1	S2
4	0.5	0.5	209.4	196.9	4	1.5	0.5	134.5	137.4
		1.0	224.1	215.3			1.0	122.7	123.5
		1.5	175.6	186.7			1.5	130.8	119.1
		2.0	170.5	169.0			2.0	148.4	112.4
4	1.0	0.5	210.2	200.6	4	2.0	0.5	124.9	122.7
		1.0	159.5	166.1			1.0	167.6	108.8
		1.5	163.1	159.5			1.5	105.6	102.1
		2.0	111.2	149.2			2.0	106.6	98.47

Table 4.3 Distribution characteristic of FDMS at various operating pressures

Emitter size		Pressure (kg/cm ²)	DC (%)		Emitter size		Pressure (kg/cm ²)	DC (%)	
l (mm)	b (mm)		S1	S2	l (mm)	b (mm)		S1	S2
4	0.5	0.5	53.1	50.0	4	1.5	0.5	64.6	66.0
		1.0	58.1	55.2			1.0	62.5	64.8
		1.5	57.9	46.2			1.5	66.0	66.6
		2.0	47.7	54.8			2.0	59.0	70.3
4	1.0	0.5	66.6	59.4	4	2.0	0.5	74.0	67.0
		1.0	56.8	53.8			1.0	70.7	73.7
		1.5	54.5	56.0			1.5	70.5	75.0
		2.0	56.0	70.3			2.0	70.7	78.9

4.2 Recommended size of the FDMS

From the extensive evaluation of the various sizes of FDMS at different operating pressures, it is found that 1 mm wide cut MS at an operating pressure of 1.0 kg/cm² yields best result when viewed from all angles. Hence, 1.0 mm wide cut micro sprinkler at an operating pressure of 1 kg/cm² is used for field performance evaluation.

Table 4.4 Possible discharge of standardized micro sprinkler

Sl. No.	Dimensions of the sprinkler		Operating pressure (kg/cm ²)	Discharge (lph)
	Length (mm)	Width (mm)		
1	4.0	0.5	1.0	39.0
2	4.0	1.0	1.0	49.0
3	4.0	1.5	1.0	60.0
4	4.0	2.0	1.0	73.0

4.3 Industry manufactured micro sprinkler

Attempt has been made to produce uniform sized micro sprinkler through standardized manufacturing processes. The design drawing and the manufacturing process of the product was finalized in consultation with the Dept of Chemistry, National Institute of Technology Calicut. Plastic injection moulding was chosen as the manufacturing process. The mould for the production of MS was developed at Messianic Mould Tool Engineering, Coimbatore. Two attempts of moulding the MS were made and the performance of them have been evaluated and the results and inferences are given in the following sections.

4.4 Hydraulic performance of the First Moulded Micro Sprinkler (FMMS)

The design drawing for the mould of FMMS is shown in fig. 4.32 and the moulded product is shown in plate 4.1.

4.4.1 Discharge

The result of the laboratory experiment carried out on FMMS are presented in fig.4.33. The mean discharge of the 0.5 mm wide cut micro sprinkler (WCMS) was 21.3 lph at 0.5 kg/cm² operating pressure. Mean discharge for other operating pressures of 1.0, 1.5 and 2.0 kg/cm² were respectively 30.1, 38.4 and 45.9 lph. Corresponding discharge values in the case of 1.0 mm WCMS were 27.7, 31.6, 35.8 and 40.9 lph respectively for the operating pressures of 0.5, 1.0, 1.5 and 2.0 kg/cm². The values were 45.6, 53.3, 59.9 and 64.4 lph for 1.5 mm WCMS. In respect of 2.0 mm WCMS, the mean discharge values varied over 48.9, 56.0, 64.6 and 74.6 lph for the different operating pressures.

Operating pressure versus discharge curve as presented in fig. 4.33 shows non linear trend for all the four different micro sprinkler sizes and the best fitted equation with RMS errors is shown against each. The variability of discharge within the same sized sprinklers was very high for 0.5 mm WCMS sprinklers under study (fig. 4.34).

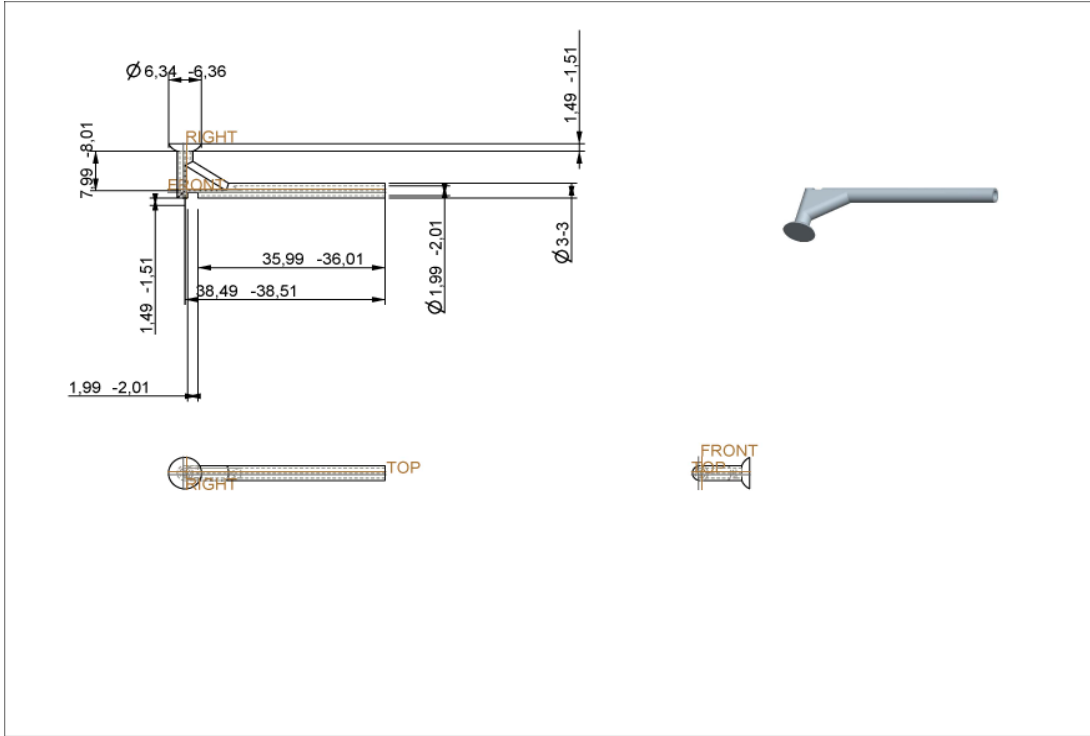

Fig. 4.32 Design drawing of the micro sprinkler sample to be moulded



Plate 4.1 Mould developed for plastic injection moulding

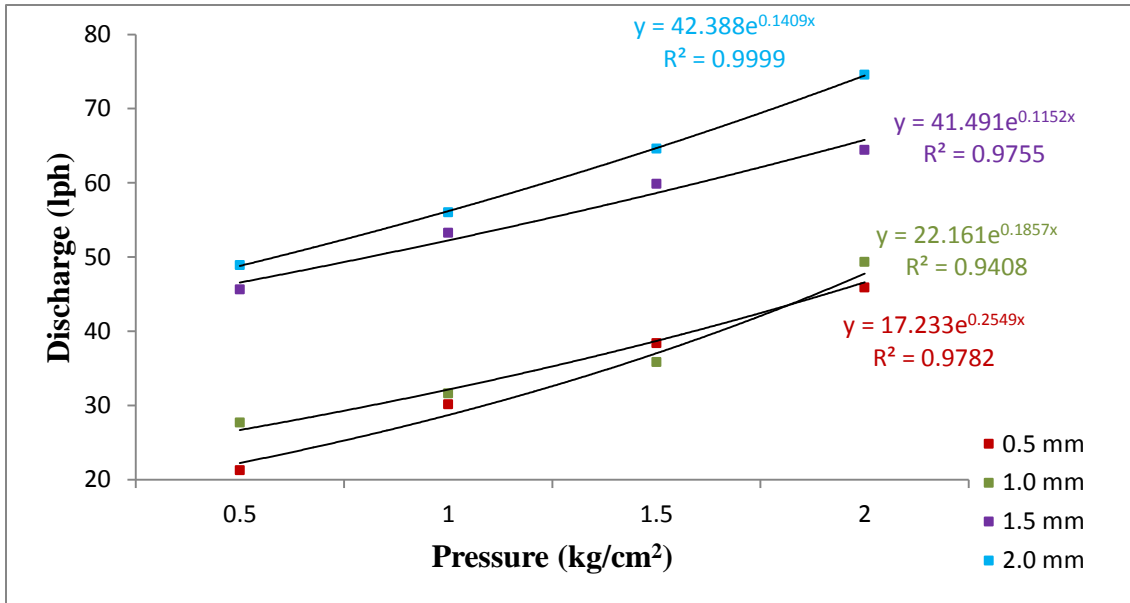

Fig. 4.33 Mean discharge of FMMS at various operating pressures



Plate 4.2 First Moulded Micro Sprinkler (FMMS)

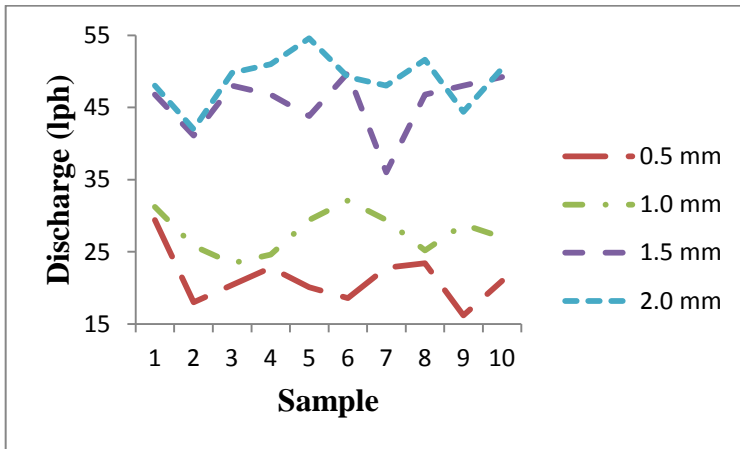

Fig. 4.34 Discharge of FMMS at 0.5 kg/cm²

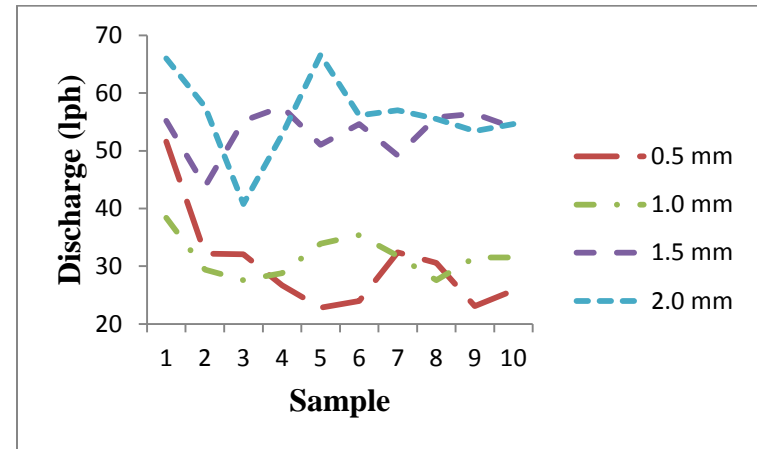

Fig. 4.35 Discharge of FMMS at 1.0 kg/cm²

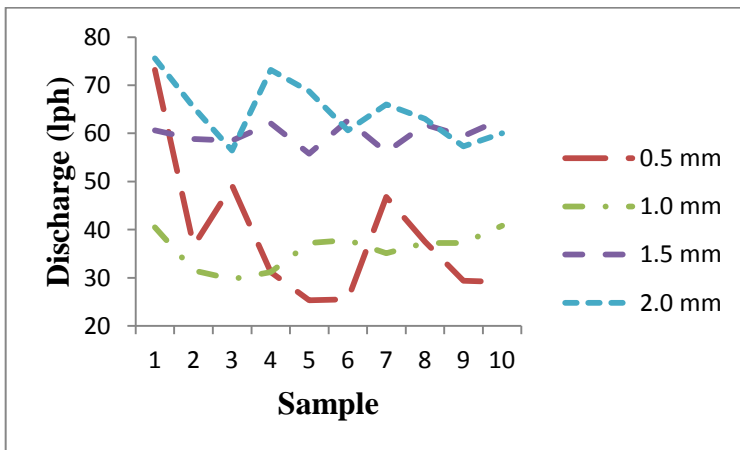

Fig. 4.36 Discharge of FMMS at 1.5 kg/cm²

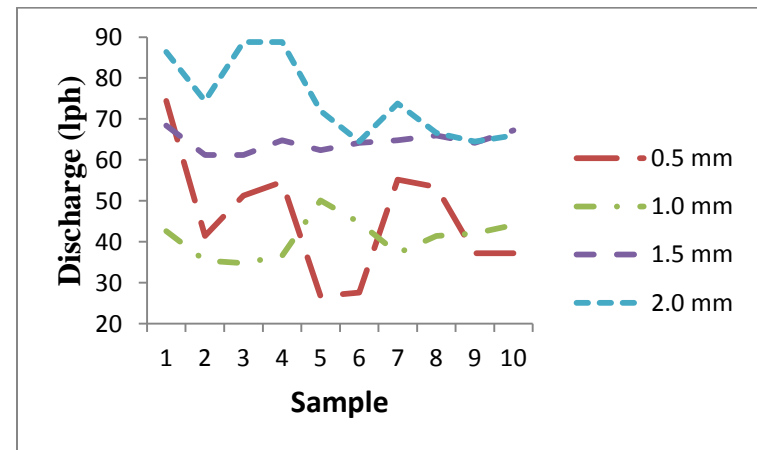

Fig. 4.37 Discharge of FMMS at 2.0 kg/cm²

It is revealed by the high COV values of 17.2, 28.1, 38.5 and 31.9% for operating pressure of 0.5, 1.0, 1.5 and 2.0 kg/cm² respectively. This variability can be attributed to some defects that crept into the manufacturing process. At the same time, the variability of discharge was lower for the case of manufactured product when compared to the FDMS for sizes 1.0, 1.5 and 2.0 mm. The variability was lowest in the case of 1.5 mm size micro sprinkler.

4.4.2. Wetted Radius

The wetted radius was calculated as the distance measured from the emitter location to the farthest point at which the emitter supplies water at a minimum rate of 0.26 mm/h. Wetted radius of the FMMS for various operating pressures are shown in fig. 4.38. The mean wetted radius for 0.5 mm WCMS at 0.5 kg/cm² is 1.38 m. The corresponding values were 1.61, 1.75 and 2.12 m respectively for other operating pressures of 1, 1.5 and 2 kg/cm². Mean wetted radius for other sprinkler sizes lied between 1.47 and 2.17 m, 1.98 and 2.48 m and 1.96 and 2.79 m respectively for 1.0, 1.5 and 2.0 mm corresponding to the operating pressures considered. Variability of the wetted radius between samples of the same sized sprinklers was significant in the case of WCMS with a COV of 27.3, 24.4, 22.4 and 20.4 % respectively for the range of operating pressures of 0.5 to 2 kg/cm². In the case of 1.0, 1.5 and 2.0 mm WCMS, the variability of wetted radius was much lower compared to 0.5 mm size and the least value was for 2 mm WCMS. The values of the wetted radius are suitable for many of the plantation crops viz. coconut, areca nut and for vegetable and fruit crops.

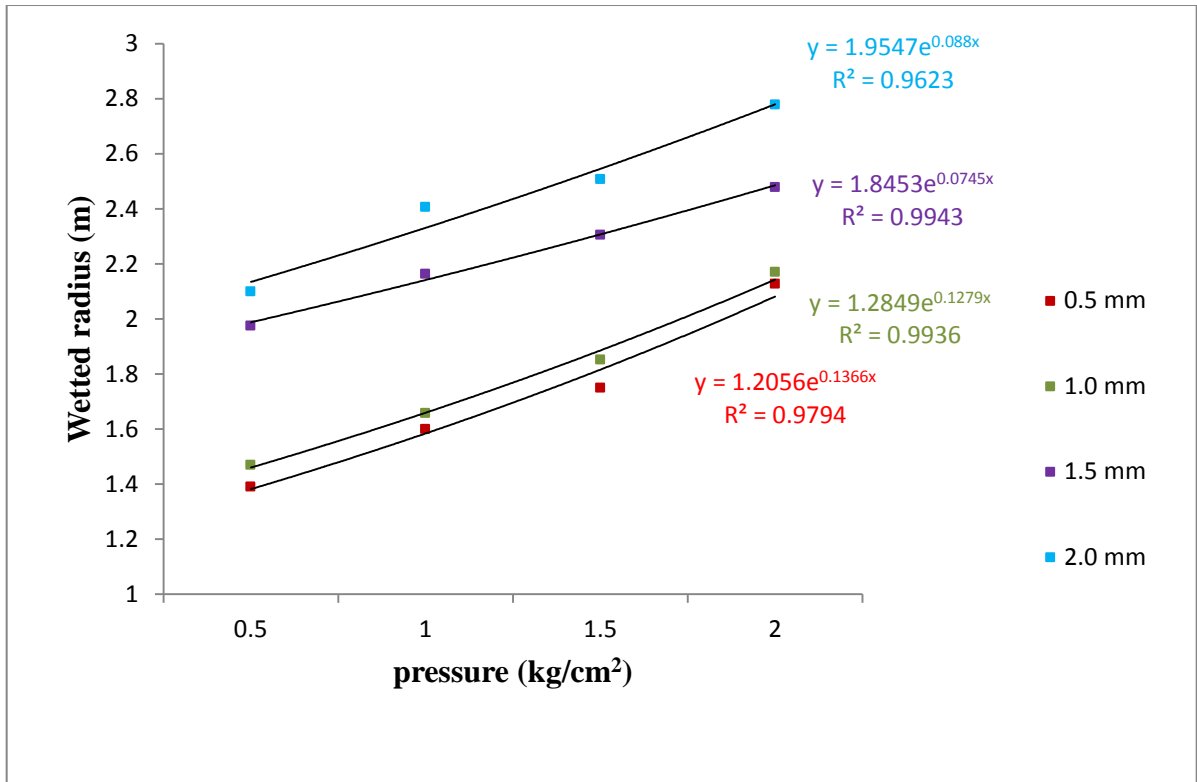

Fig. 4.38 Mean wetted radius of FMMS at various operating pressures

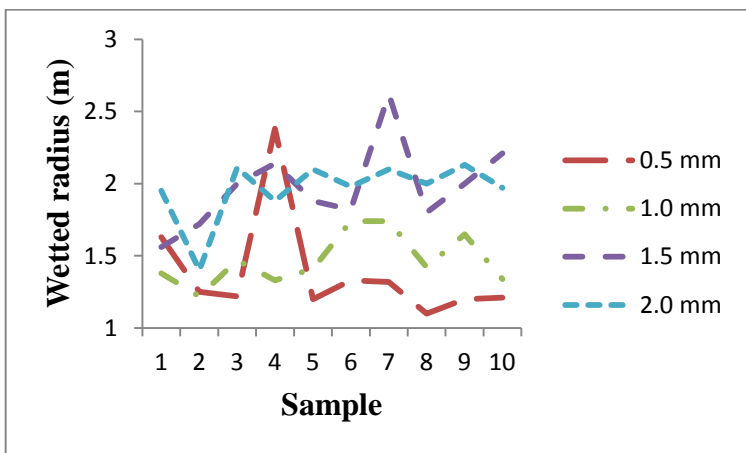

Fig. 4.39 Wetted radius of FMMS at 0.5 kg/cm²

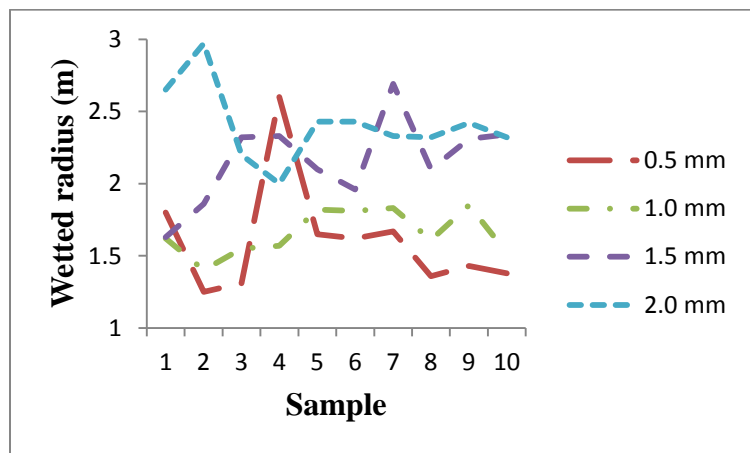

Fig. 4.40 Wetted radius of FMMS at 1.0 kg/cm²

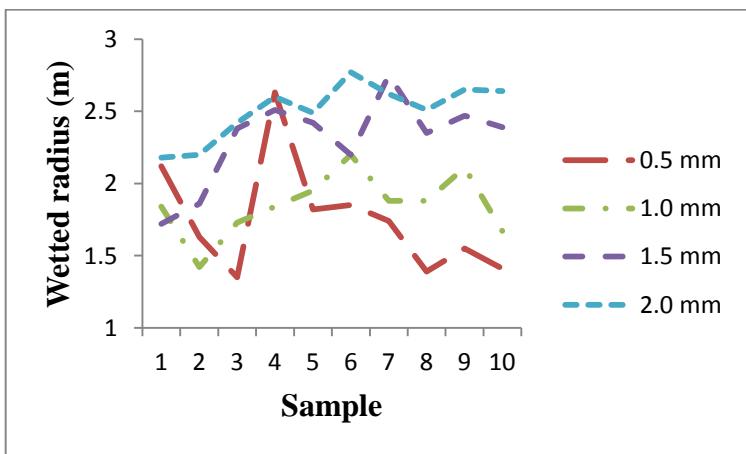

Fig. 4.41 Wetted radius of FMMS at 1.5 kg/cm²

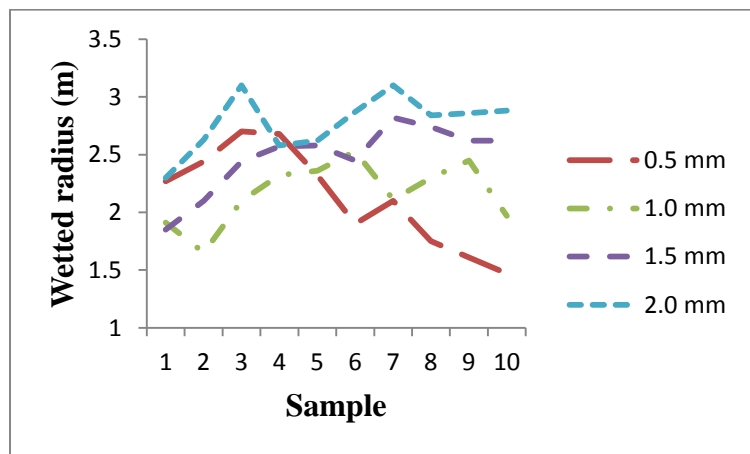

Fig. 4.42 Wetted radius of FMMS at 2.0 kg/cm²

4.4.3 Mean water application depth

The mean water application depth of the FMMS and its variability is shown in fig. 4.43. In the case of 0.5 mm WCMS water application depth decreases from 15.6 to 14.0 mm/h as operating pressure increases from 0.5 kg/cm² to 2.0 kg/cm². The corresponding decrease was 16.7 to 11.4 mm/h, 15.8 to 14.0 mm/h and 16.7 to 12.7 mm/h respectively for 1.0, 1.5 and 2.0 mm size micro sprinklers. Highest mean application depth observed was 16.7 mm/h. The variability of water application depth within same sized sprinklers was significantly high with COV values of 31.4, 39.4, 47.1 and 42.4 %. Corresponding values in the case of 2 mm WCMS were 24.3, 17.9, 23.8 and 28.8 %. In other sizes also the variability was considerable.

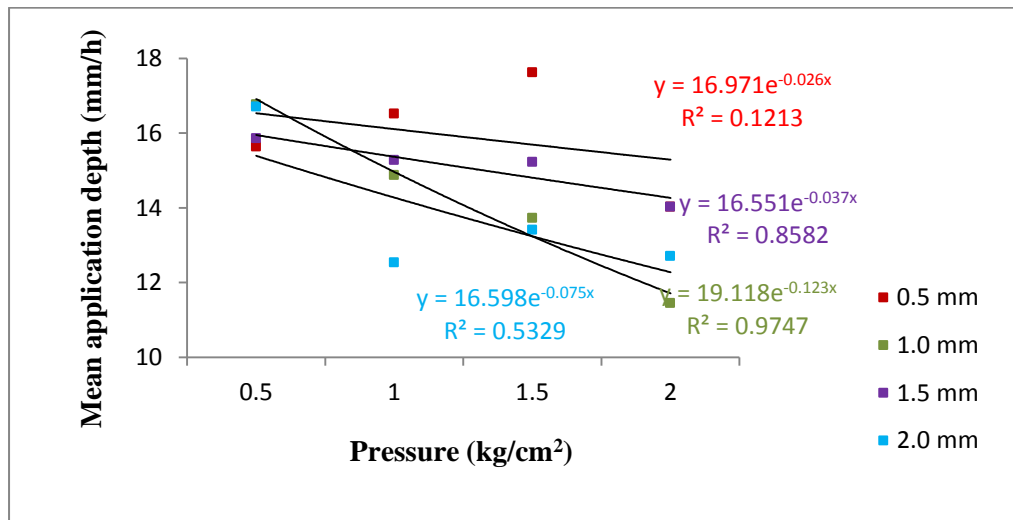

Fig. 4.43 Mean application depth of FMMS at various operating pressures

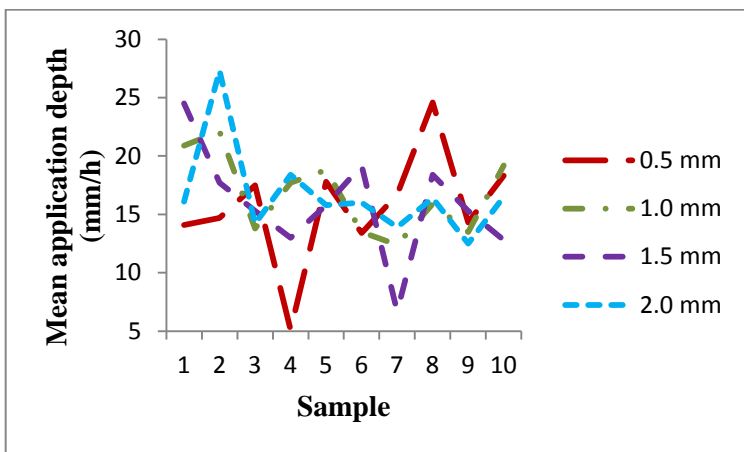

Fig. 4.44 Mean application depth of FMMS at 0.5 kg/cm²

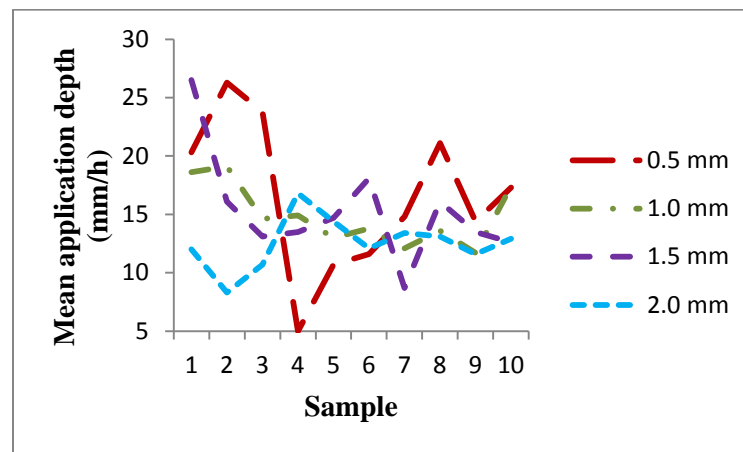

Fig. 4.45 Mean application depth of FMMS at 1.0 kg/cm²

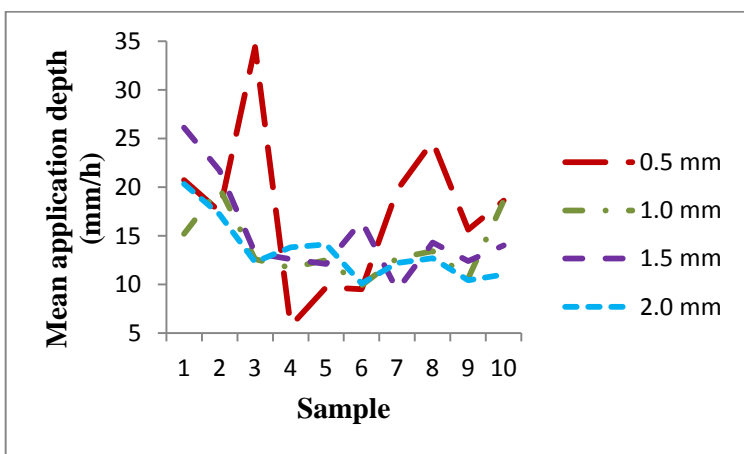

Fig. 4.46 Mean application depth of FMMS at 1.5 kg/cm²

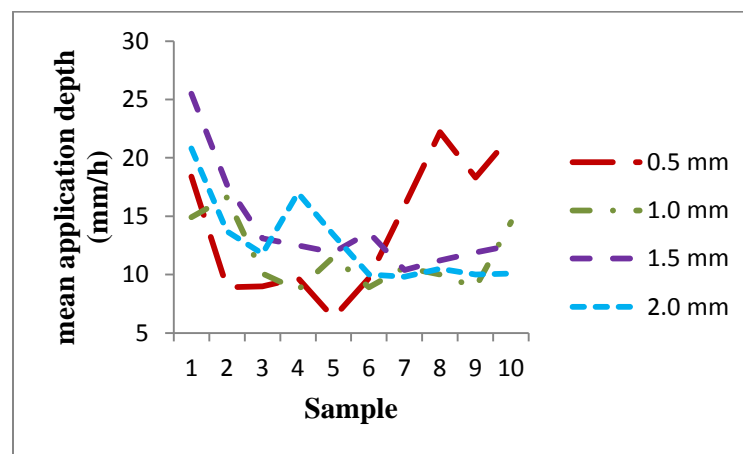

Fig. 4.47 Mean application depth of FMMS at 2.0 kg/cm²

4.4.4 Inference on the hydraulic performance of the FMMS

The hydraulic study has proved that there is considerable sample to sample variation for the FMMS. It was found that the incisions are not uniform in shape, more problems being observed in smaller size, and the major reason for the same was the small diameter of the micro tube on which the incision is made. Hence, it was decided to increase the diameter of the micro tube and go for modification in the design of the mould and moulding of the new micro sprinkler.

4.5. Hydraulic performance of the Second Moulded Micro Sprinkler (SMMS)

4.5.1 Discharge

The results of the discharge studies carried out on SMMS are presented in Fig. 4.48. The mean discharge of the 0.5 mm cut micro sprinkler was 58.0 at 0.5 kg/cm² operating pressure. Mean discharge for other operating pressures of 1, 1.5 and 2.0 kg/cm² respectively 64.1, 71.4 and 79.7 lph. Corresponding discharge values in the case of 1.0 mm WCMS were 61.6, 77.9, 84.1 and 89.0 lph. The values were 63.7, 82.4, 92.9, 104.0 lph for 1.5 mm WCMS. In respect of 2.0 mm WCMS, the mean discharge values varied through 77.5, 87.5, 100.2 and 110.4 lph.

Operating pressure versus discharge curve as presented in fig. 4.48 shows non linear trend for all the four different micro sprinkler sizes and the best fitted equation with RMS errors is shown against each. The variability of discharge within the same size sprinklers was low for all the four different sized sprinklers under study (fig. 4.49, 4.50, 4.51 and 4.52). The highest COV obtained 10.1% for 0.5 mm WCMS at 1.5 kg/cm². In most of the cases, the COV ranges between 4.0 to 7%. It can be inferred that as diameter of the micro tube increases, variability in discharge decreases. However, the discharge values are higher and may lead to surface runoff.

4.5.2 Wetted radius

The wetted radius was calculated as the distance measured from the emitter location to the farthest point at which the emitter supplies water at a minimum rate of

0.26 mm/h. Wetted radius of the SMMS for various operating pressures are shown in fig. 4.53. The mean wetted radius for 0.5 mm wide cut sprinkler at 0.5 kg/cm² is 1.62 m. The corresponding values were 1.68, 1.81 and 1.97 m respectively for other operating pressures of 1, 1.5 and 2 kg/cm². Mean wetted radius for other sprinkler sizes lied between 1.58 to 1.92 m, 2.0 to 2.75 m, and 2.37 to 2.75 m respectively for 1.0, 1.5 and 2.0 mm WCMS. Variability of the wetted radius between samples of the same size sprinklers were in general low with the COV values ranging between 4.9 to 10.9%. The values of the wetted radius are suitable for many of the plantation crops viz. coconut, areca nut and for vegetable and fruit crops.

4.5.3 Mean water application depth

The mean water application depth of the SMMS and its variability is shown in fig. 4.58. In the case of 0.5 mm WCMS water application depth vary from 28.2 to 26.6 mm/h for an operating pressure of 0.5 kg/cm². The corresponding variation is 31.7 to 31.8 mm/h, 20.5 to 17.6 mm/h and 17.7 to 18.7 mm/h respectively for 1.0, 1.5 and 2.0 mm WCMS. In general, the application depths are higher and are suitable only for soils of high infiltration rate. The variability of application depth as indicated by COV varies from 4.6 to 11.4% for 0.5 mm WCMS, 17.4 to 21.9% for 1.0 mm WCMS, 8.3 to 19.6% for 1.5 mm WCMS and 11.5 to 17.5% for 2.0 mm WCMS.

4.5.4 Inference on the hydraulic performance of the SMMS

The emitter discharge and the water application rate of the SMMS were higher than the desirable limit for most of the commonly seen soils. Sample to sample variation of same sized SMMS was also considerably high. It may be concluded that further refinement in the manufacturing process is required to produce more uniformly performing micro sprinklers in terms of discharge, wetted radius and water application depth. One of the suggestions is that if moulding of the body of the micro sprinkler and the incision cutting are done through two separate manufacturing processes, better uniform sized products may be possible.

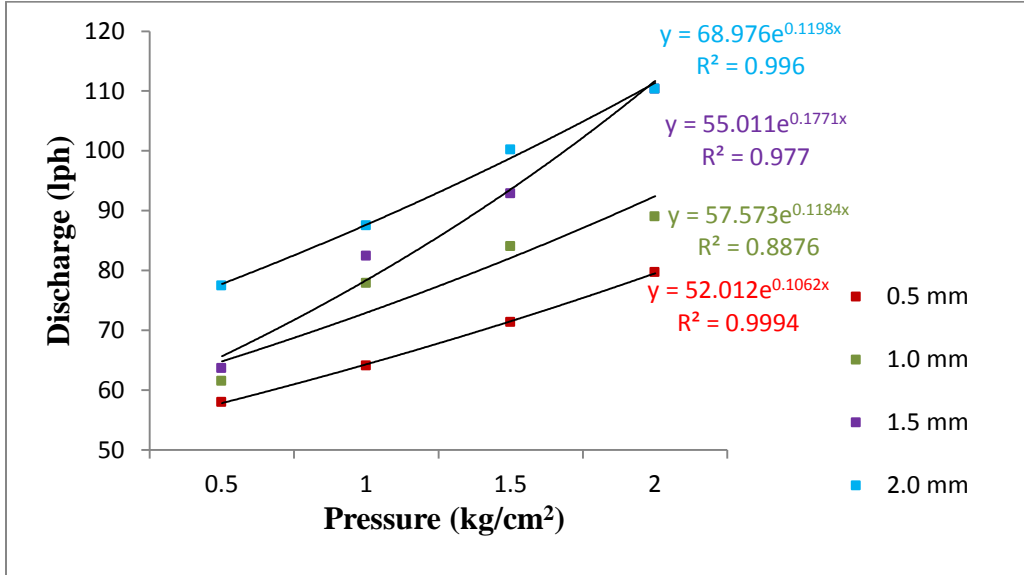

Fig. 4.48 Mean discharge of SMMS at various operating pressures



Plate 4.3 Second Moulded Micro Sprinkler (SMMS)

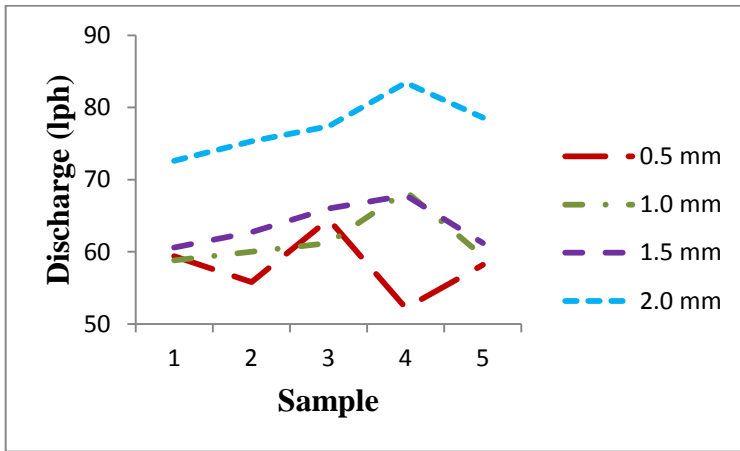

Fig. 4.49 Discharge of SMMS at 0.5 kg/cm²

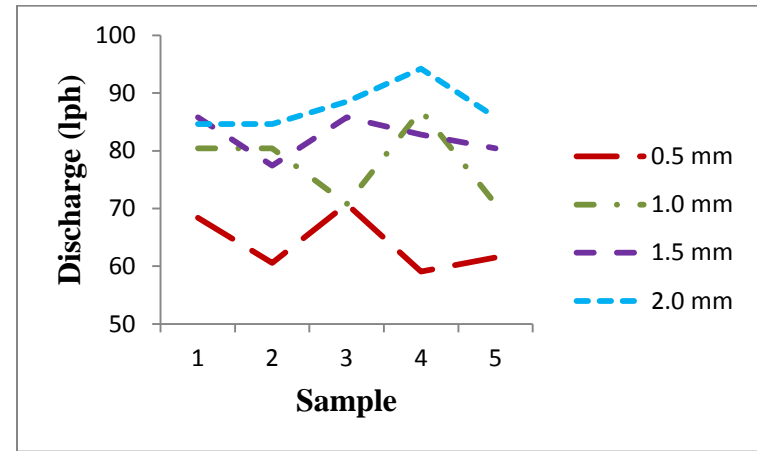

Fig. 4.50 Discharge of SMMS at 1.0 kg/cm²

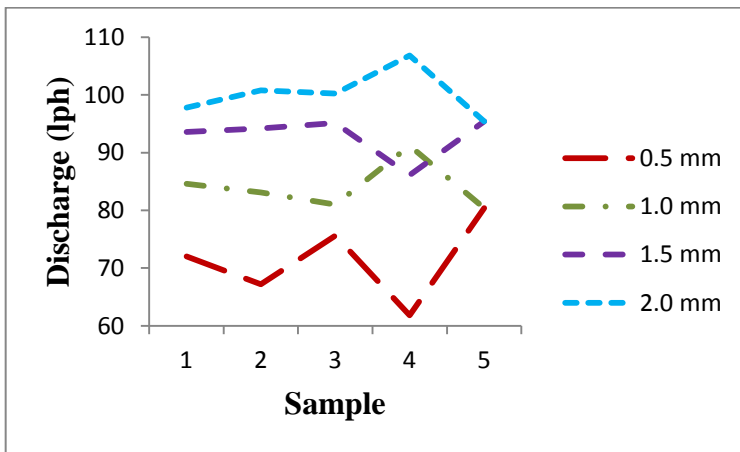

Fig. 4.51 Discharge of SMMS at 1.5 kg/cm²

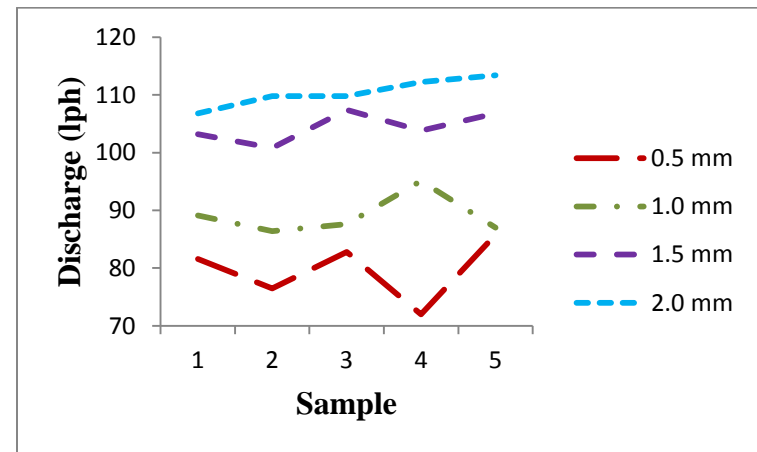

Fig. 4.52 Discharge of SMMS at 2.0 kg/cm²

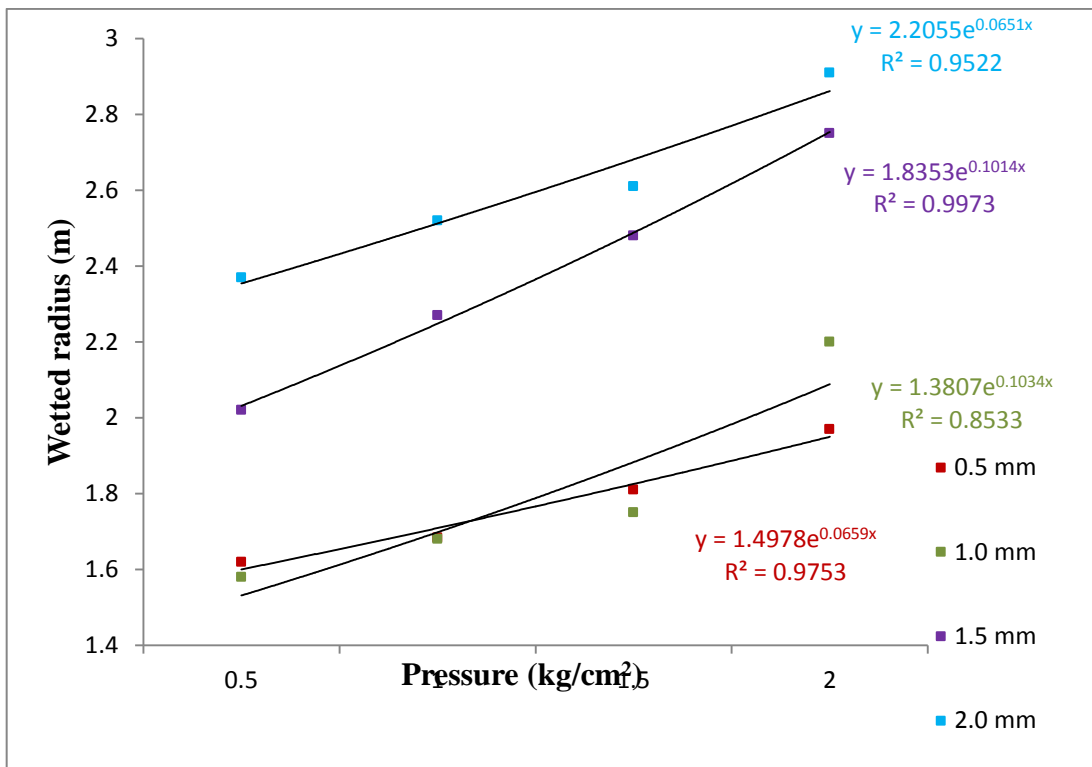

Fig. 4.53 Mean wetted radius of SMMS at various operating pressures

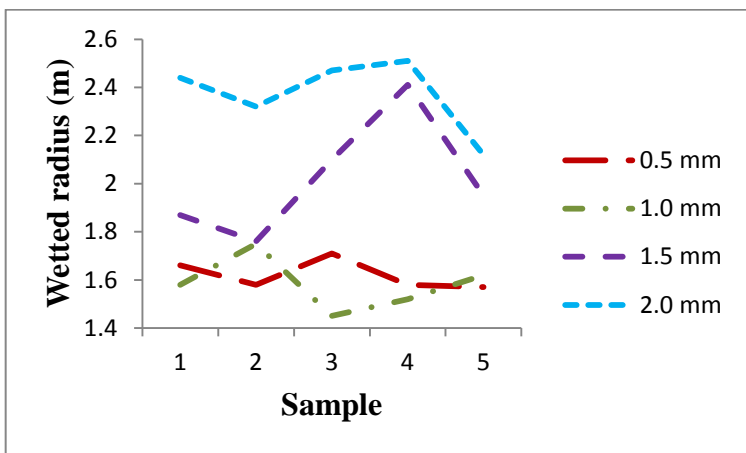

Fig. 4.54 Wetted radius of SMMS at 0.5 kg/cm²

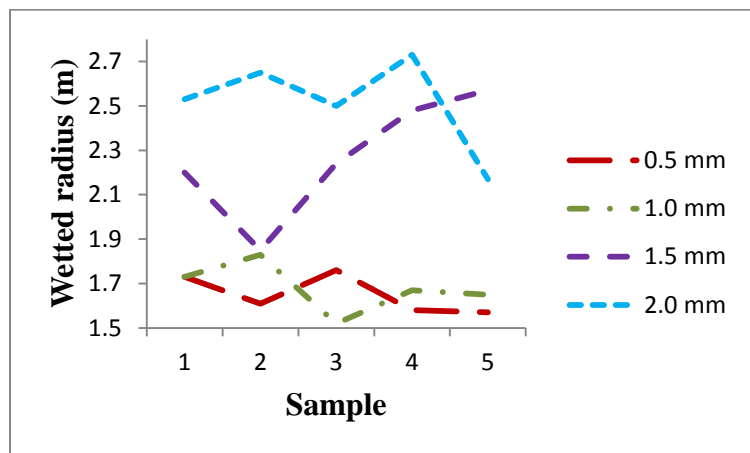

Fig. 4.55 Wetted radius of SMMS at 1.0 kg/cm²

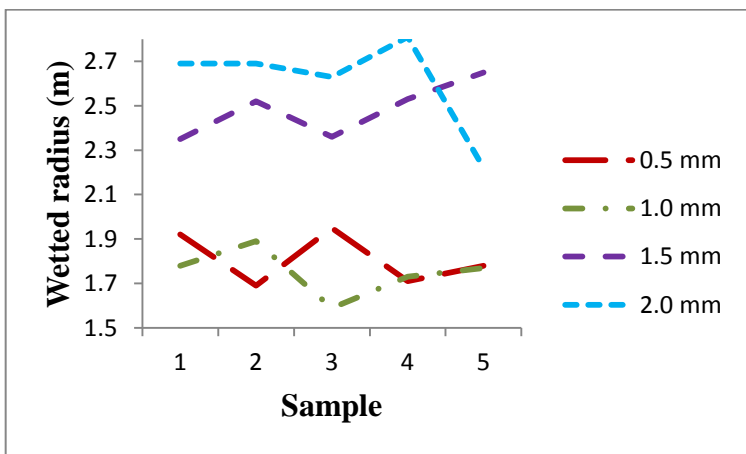

Fig. 4.56 Wetted radius of SMMS at 1.5 kg/cm²

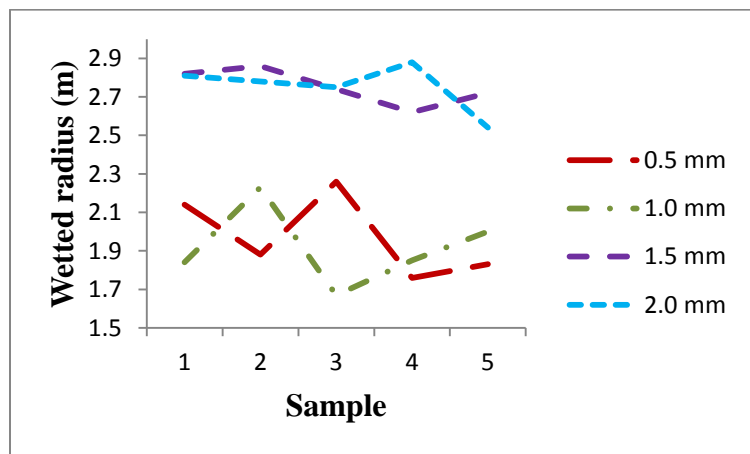

Fig. 4.57 Wetted radius of SMMS at 2.0 kg/cm²

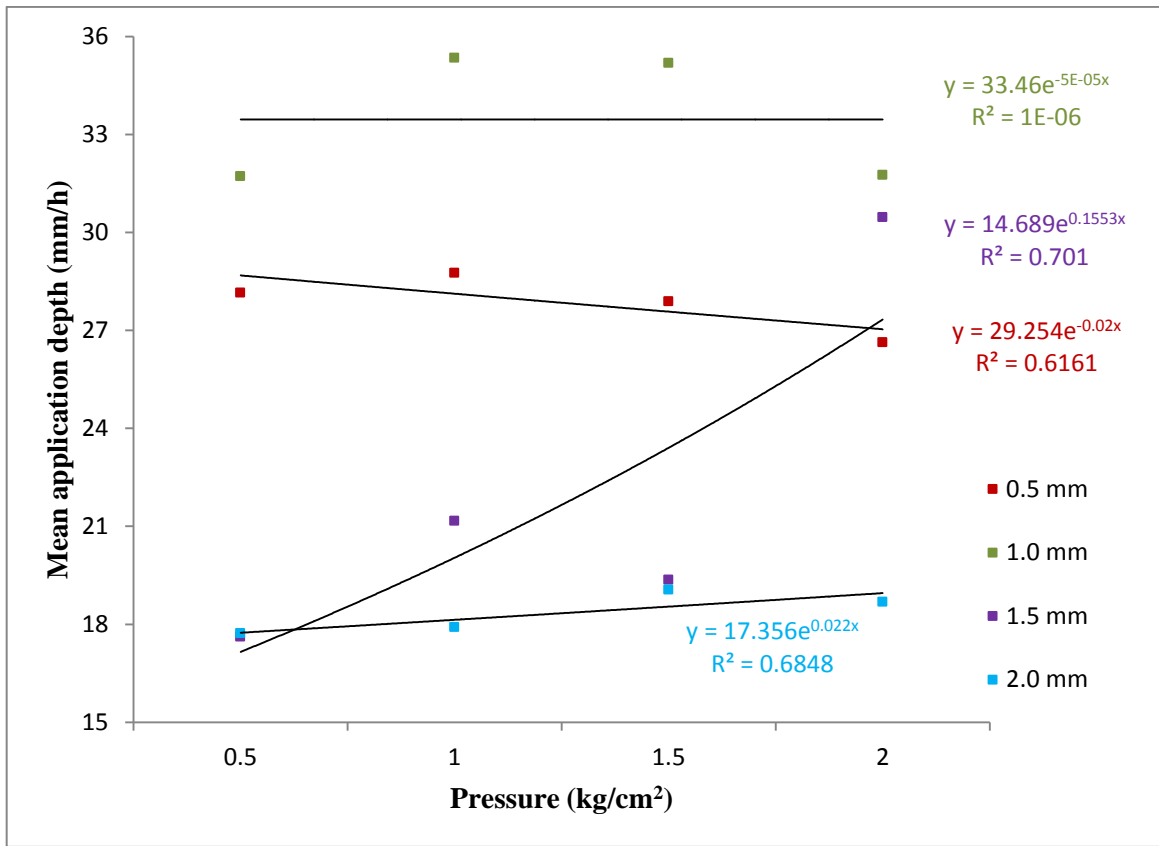

Fig. 4.58 Mean application depth of SMMS at various operating pressures

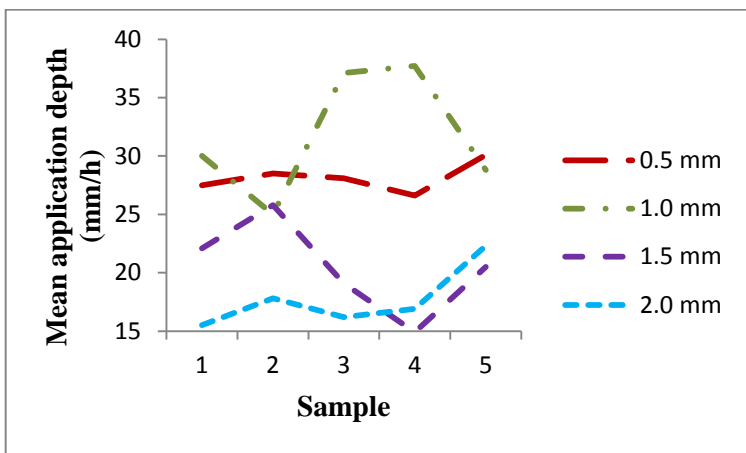

Fig. 4.59 Mean application depth of SMMS at 0.5 kg/cm²

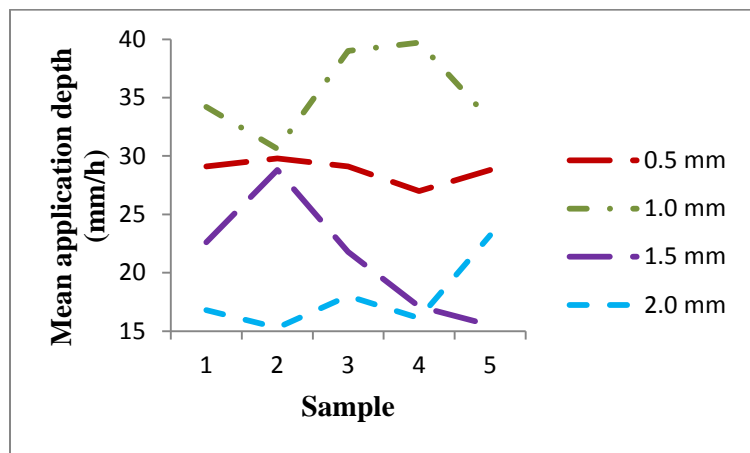

Fig. 4.60 Mean application depth of SMMS at 1.0 kg/cm²

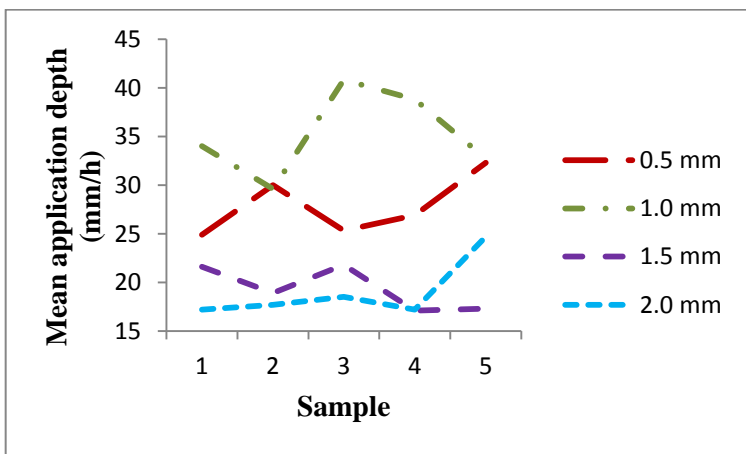

Fig. 4.61 Mean application depth of SMMS at 1.5 kg/cm²

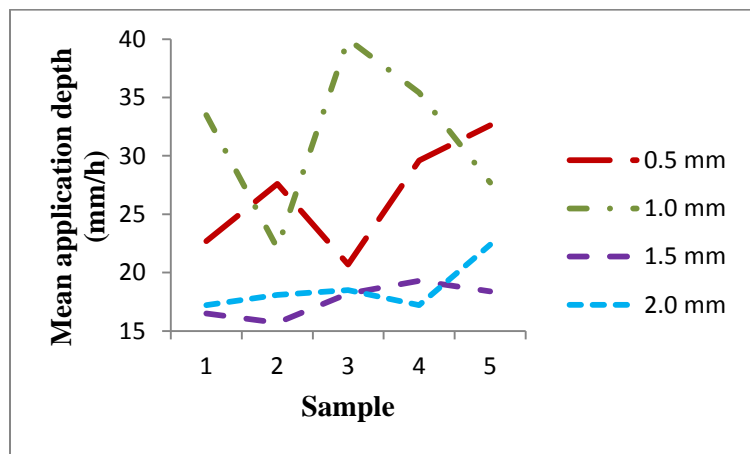

Fig. 4.62 Mean application depth of SMMS at 2.0 kg/cm²

4.6 Field performance of the FDMS

To evaluate the micro sprinkler for irrigating vegetable crops, a cucumber variety *Saubhagya* was cultivated and micro sprinkler (FDMS) was laid as described in section 3.7.3. Only 1mm wide cut FDMS was used in the study as this model was found to be the best out of 4 models, after the hydraulic study. Micro sprinklers giving near uniform discharge (50 to 60 lph) were selected for the study. The observations and their inferences on soil moisture distribution, soil temperature, number of female flower per plant, yield and fruit characteristics are described in the forth coming sections.

4.6.1 Effect of micro sprinkler treatments on soil moisture distribution

Soil moisture measured from different locations of surface and sub surface layers for different treatments are presented in table 4.5 and 4.6. Mean value of moisture content at surface level in the case of non-mulched field is 11.4%, 9.5% and 7.5% for 100, 75 and 50% levels of irrigation. Mean value of the corresponding moisture content below 30 cm depth was 4.7, 4.5 and 3.2%. In the case of paper mulched fields, the mean moisture content was 10.3, 9.1 and 6.6 % corresponding to the three levels of irrigation in the order mentioned above. In the case of straw mulch, the above values were respectively 16.3, 10.9 and 6.8%. At 30 cm depth, moisture content for straw mulched plots was 7.1, 5.0 and 3.1% respectively. It can be seen that the FDMS is able to maintain the desired level of moisture in both mulched and non-mulched plots.

Coefficient of variation of moisture content within the basin was 18% for 100% irrigation and 13% for 75% irrigation in the case of non-mulched fields. For paddy straw mulch, the COV of surface moisture was 18.2% for 100% irrigation and 7.5% for 75% level of irrigation.

Table 4.5 Effect of micro sprinkler treatments on moisture distribution at the surface (%)

Treatment	C1	C2	C3	C4	Centre
T1	6.30	16.40	8.90	9.80	6.00
T2	11.50	13.80	13.00	9.00	9.60
T3	7.30	8.20	7.90	5.80	8.05
T4	8.90	14.70	9.30	8.30	10.40
T5	9.30	11.40	8.50	7.20	9.00
T6	6.10	7.04	6.90	5.70	7.20
T7	14.10	20.43	15.10	13.60	18.50
T8	9.20	17.80	8.70	7.20	11.50
T9	6.60	7.50	6.90	6.10	7.00

Table 4.6 Effect of micro sprinkler treatments on moisture distribution at 30 cm depth from the surface (%)

Treatment	C1	C2	C3	C4	Centre
T1	3.52	7.58	4.00	4.31	3.00
T2	4.87	5.35	5.41	3.97	4.00
T3	3.10	3.50	3.70	3.30	2.34
T4	4.13	6.63	4.30	3.63	4.90
T5	3.90	5.50	3.47	3.15	4.00
T6	2.64	2.40	2.90	2.40	3.10
T7	6.22	9.47	7.00	4.53	8.35
T8	4.40	7.24	4.20	3.80	5.26
T9	2.73	4.20	2.90	2.13	3.30

4.6.2 Effect of micro sprinkler treatments on soil temperature

Mean soil temperature measured from 5 cm depth from the basin of the plant is shown in fig. 4.63. Mean value of soil temperature in the non-mulched field was 29, 32 and 35⁰C respectively for 100%, 75% and 50% levels of irrigation in the non-mulched fields. Corresponding temperature in the straw mulched fields were 28.1, 29.7 and 31.4⁰C. Increase in soil temperature was evident as the level of irrigation was decreased in both mulched and non-mulched fields.

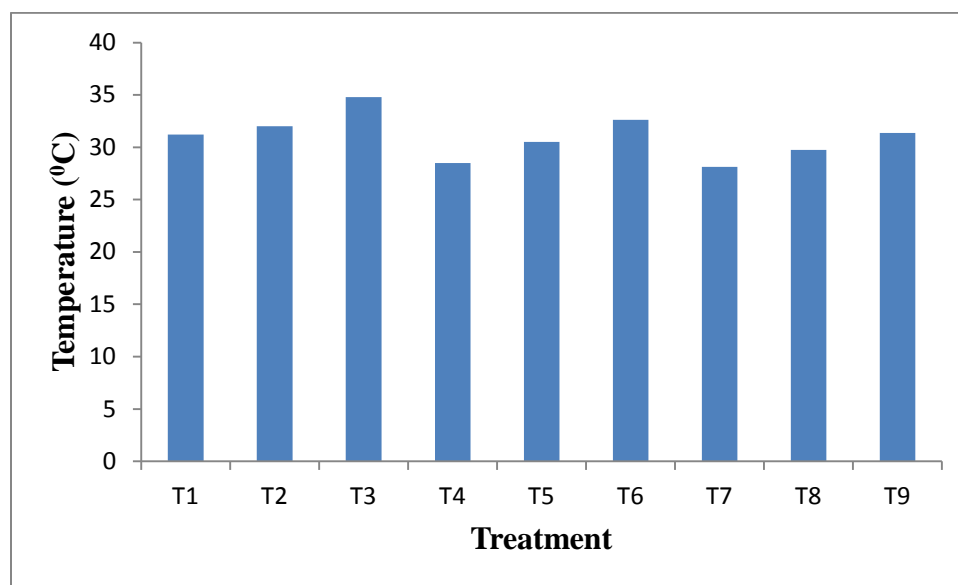

Fig. 4.63 Effect of micro sprinkler treatments on soil temperature in the field

4.6.3 Effect of micro sprinkler treatments on number of female flowers per plant

Mean value of female flowers one month after sowing in the non-mulched fields were respectively 6, 6 and 5 for 100, 75 and 50% level of irrigation. Corresponding figures in the case of paper and straw mulched fields are 8, 7 and 6 and 9, 7 and 5 respectively. Variations in levels of irrigation have marked significance on the number of female flowers. The combination of 100% irrigation with paddy straw mulching appeared to be the best followed by 100% irrigation and paper mulch from the point of view of number of female flowers.

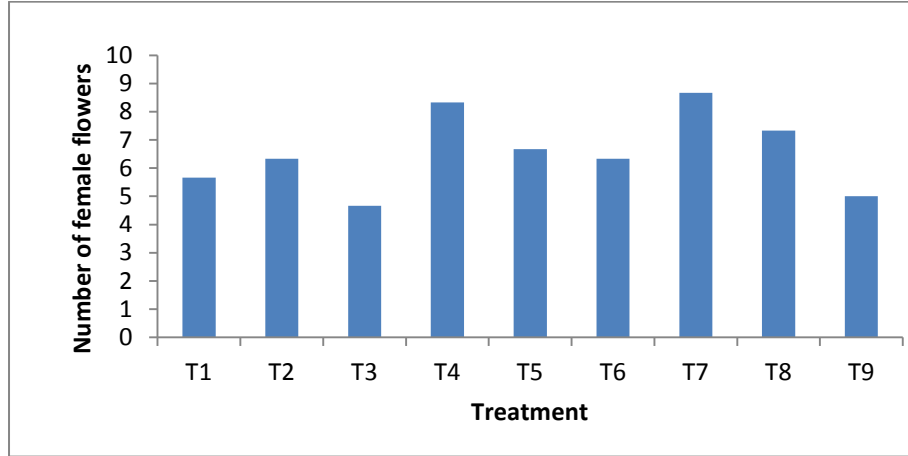

Fig. 4.64 Effect of micro sprinkler treatments on number of female flowers per plant

Table 4.7 Data on growth and yield of cucumber

Treatments	Parameters				
	Number of female flowers	Number of fruits per plant	Fruit length (cm)	Fruit girth (cm)	Yield (kg/plant)
T1	5.67 ^{bc}	5.33 ^{ab}	22.03	28.80	3.99 ^{cd}
T2	6.33 ^{abc}	5.00 ^{ab}	22.80	29.70	3.23 ^d
T3	4.67 ^c	4.33 ^b	21.37	28.93	3.22 ^d
T4	8.33 ^a	6.67 ^a	23.87	28.57	4.80 ^{bc}
T5	6.67 ^{abc}	6.33 ^{ab}	24.27	29.57	5.27 ^b
T6	6.33 ^{abc}	4.33 ^b	20.93	29.20	3.96 ^{cd}
T7	8.67 ^a	6.67 ^a	23.53	30.27	6.37 ^a
T8	7.33 ^{ab}	6.67 ^a	23.10	28.60	5.68 ^{ab}
T9	5.00 ^{bc}	4.67 ^{ab}	22.83	30.50	5.27 ^b
CD (0.05)	2.34	1.89	NS	NS	0.99



Plate 4.4 Micro sprinkler in the field



Plate 4.5 A view of the harvested cucumber

4.6.4 Effect of micro sprinkler treatments on yield of cucumber

Yield of cucumber obtained from different plants from different treatments are presented in table 4.7 and fig. 4.65. Mean yield received from non-mulched treatments was 3.99, 3.23 and 3.21 kg/plant corresponding to 100, 75 and 50% irrigation respectively. For the mulched treatments, mean yields were 4.80, 5.27 and 3.96 kg/plant (paper mulched) and 6.37, 5.68 and 5.27 kg/plant (straw mulched). Variation in yield between the replications is minimum in the case of straw mulch and maximum for non-mulched case.

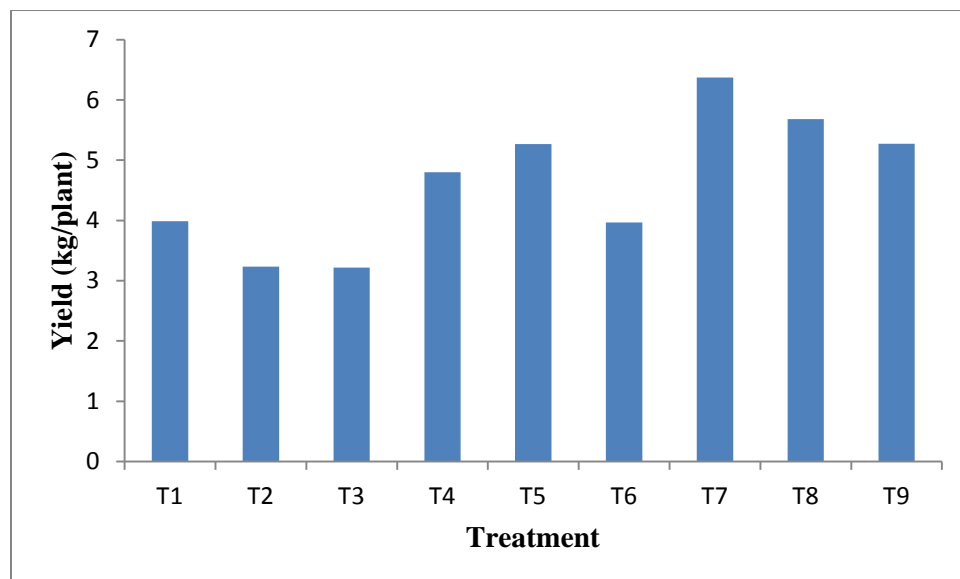

Fig. 4.65 Effect of micro sprinkler treatments on yield of Cucumber

4.6.5 Effect of micro sprinkler treatments on fruit Characteristics of cucumber

Marketability of the fruit depends upon the length and girth of the fruit and hence, an attempt has been made to analyse the impact of treatment combination on these fruit attributes. Mean fruit lengths were 22.0, 23.9 and 23.6 cm respectively for non-mulched, paper mulched and straw mulched plots corresponding to 100% irrigation. For 75% level of irrigation, these values were 22.8, 24.3 and 23.1 cm respectively.

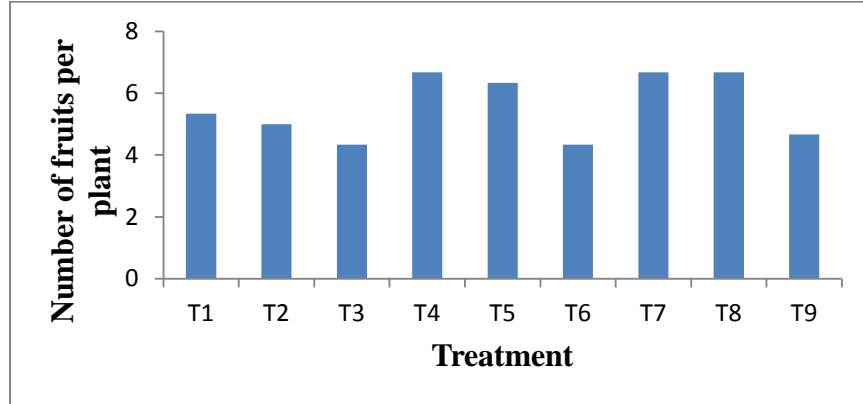

Fig. 4.66 Effect of micro sprinkler treatments on number of fruits per plant

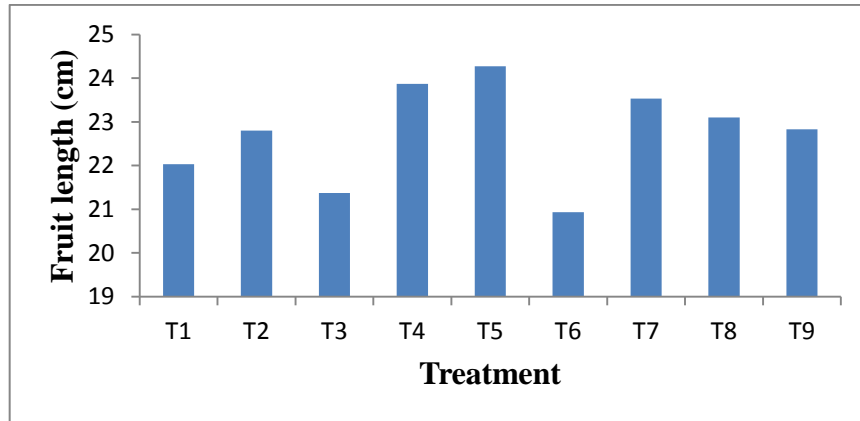

Fig. 4.67 Effect of micro sprinkler treatments on fruit length

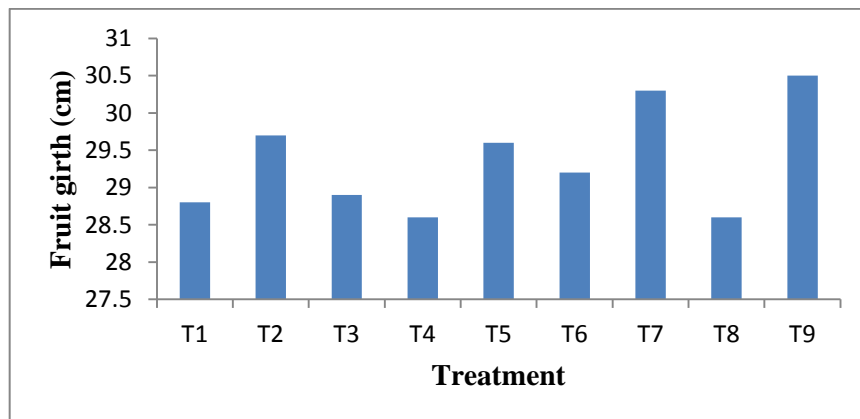

Fig. 4.68 Effect of micro sprinkler treatments on fruit girth

4.6.6 Effect of micro sprinkler treatments on water use efficiency

Water use efficiency for different treatment combinations are shown in fig. 4.69. Mean water use efficiency of the non-mulched crops were 72.4, 83.7 and 89.3 kg/ha/mm respectively corresponding to 100, 75 and 50% levels of irrigation. Corresponding figures for paper mulched crops were 108.0, 118.8 and 157.4 kg/ha/mm and that for straw mulched were 117.8, 147.4 and 195.6 kg/ha/mm. The results show that different levels of irrigation have marked influence on water use efficiency and it increases as the levels of irrigation decreases. Higher water use efficiency was shown by straw mulched treatments. Maximum water use efficiency was for the combination of straw mulch with 50% level of irrigation

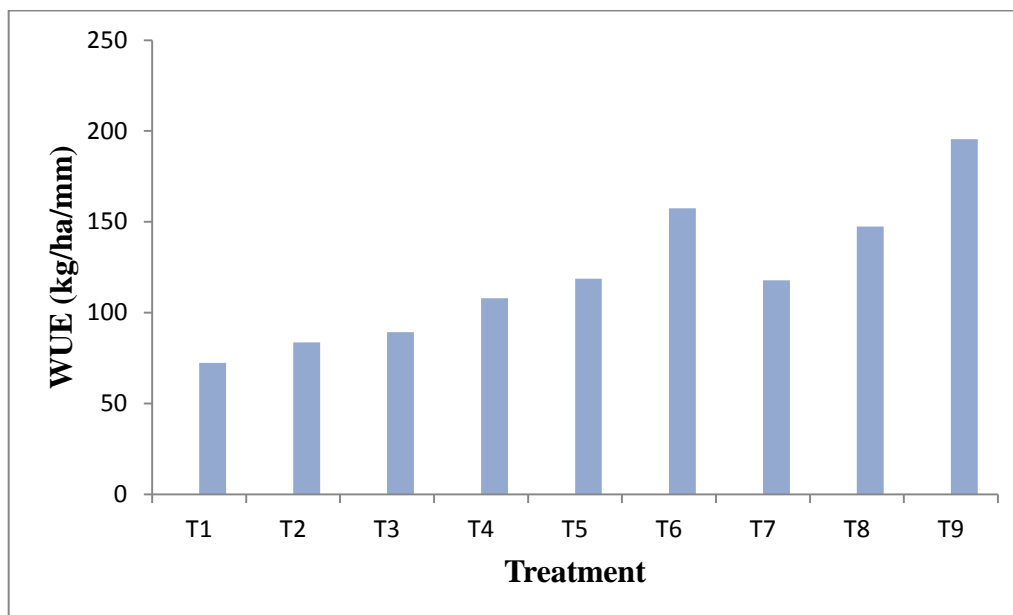

Fig. 4.69 Effect of micro sprinkler treatments on water use efficiency

4.7 Best treatment combination

From the analysis of the suitability of the farmer developed micro sprinkler for cucumber crop, it can be concluded that straw mulch with 100% irrigation is the best from the point of view of yield. Whereas, in the case of water use efficiency, straw mulch with 50% irrigation is the best management practice followed by straw mulch with 75% level of irrigation. Places, where water scarcity is experienced, straw mulch with restricted irrigation can be thought of as a feasible alternative.

SUMMARY AND CONCLUSION

CHAPTER 5

SUMMARY AND CONCLUSIONS

Micro sprinkler is a low discharge sprinkler that combines the advantages of the conventional sprinkler system and the modern drip irrigation system. It requires lesser energy than conventional sprinklers and is less susceptible to clogging than drip emitters. It has much larger area of coverage than drip emitters. Micro sprinkler irrigation has gained attention during recent years because of its potential to increase yields and decrease water use, fertilizer and labor requirements. The new micro sprinkler used in this study is developed by a farmer and is made from 3 mm diameter LDPE micro tubes. As this micro sprinkler is manually made using indigenous technology, there exists large variation in the dimensions of cut from one sample to another. The hydraulic and field performance of the micro sprinkler was tested in this study.

Micro sprinkler developed by the farmer in 4 different dimensions were tested in 4 different operating pressures to evaluate the hydraulic performance. The flow rate of the micro sprinkler with 0.5 mm wide cut was in the range of 30 lph to 54 lph, corresponding to a pressure variation of 0.5 to 2.0 kg/cm². In the case of 1.0 mm wide cut micro sprinkler, the corresponding discharge variation was 38 lph to 60 lph. Flow rate was varying from 44 lph to 76 lph in 1.5 mm wide cut micro sprinkler. The values were between 50 lph to 91 lph for 2.0 mm wide cut micro sprinkler.

The catch can data collected for the micro sprinklers was used to analyse the water application performance. The different factors used to analyse the performance were wetted radius, average application depth, uniformity coefficient, coefficient of variation, distribution characteristic and distribution pattern.

The maximum wetted radius obtained for the micro sprinkler was 2.6 m for width of cut 2.0 mm at a pressure of 2 kg/cm². The minimum wetted radius obtained was 2.0 m for 1.0 mm wide cut at 0.5 kg/cm². These values show that this micro

sprinkler can be adopted for most of the crops such as arecanut, coconut, banana and vegetables growing in Kerala state, India. The mean application depth was observed during the 1 h catch can test. The mean application depth was varying considerably according to the width of cut and pressure applied. The highest mean application depth was 17.7 mm/h shown by micro sprinkler with width of cut 2.0 mm at 1.5 kg/cm² and the lowest value was 7.8 mm for 0.5 mm wide cut at 0.5 kg/cm².

The highest CUC was 41.8% at 0.5 kg/cm² shown by micro sprinkler with 0.5 mm wide cut. In general the values of uniformity coefficient are low in the case of single sprinkler operations. Even between the same sized micro sprinklers, there exists a high variation in the values of uniformity coefficient. This is due to the sample to sample variations in the dimensions of cut made for the micro sprinkler. Many of the commercially available sprinklers are reported have a CUC value in the range of 30-40%. Hence the values of CUC obtained for the micro sprinkler are satisfactory.

The coefficient of variation (COV) of the micro sprinkler was also determined from the catch can test. Based on the COV values the best performance was shown by 2 mm wide cut micro sprinkler (98.47% at 2 kg/cm²). The lowest value of COV (215.31%) was shown by the micro sprinkler with 0.5 mm wide cut at 1.0 kg/cm² and the other micro sprinklers have shown COVs between 100% and 200%. This high percentage variation may be due to the non standardised manual cut given by the farmer. Hence, this observation necessitates the standardisation of the product. Further, the distribution characteristic (DC) of the micro sprinkler was calculated for each sample at four different pressures. The best performance was shown by the micro sprinkler with width of cut 2.0 mm at 2.0 kg/cm² (78.90%). The lowest DC obtained was 50.0% for the micro sprinkler with 0.5 mm wide cut at 0.5 kg/cm². It is observed that about 80% of the total wetted area receives more than half of the mean application depth. The moisture distribution pattern of the micro sprinkler for different width of cut was drawn using the software 'SURFER'.

An attempt was made to produce the micro sprinkler with standardised dimensions by plastic injection moulding. The hydraulic performance of industry manufactured micro sprinklers was not promising and needed further refinement. It is felt that if sprinkler head moulding and nozzle-cutting are done through two separate manufacturing processes, better performing micro sprinkler heads could be manufactured. Hence, there is further scope of research in this area.

The field performance of the farmer developed micro sprinkler was done at the instructional farm, KCAET, Tavanur. The crop chosen for the study was Cucumber (*Cucumis melo var. cocomon*) and variety selected was 'Saubhagya'. Randomised Complete Block Design was used for the study which comprised of 9 treatments with 3 replications. The irrigation levels selected for the study were 100%, 75% and 50% of the recommended irrigation as per the Package of Practices recommendations of KAU and two mulches viz. news print paper and paddy straw were used. The total cultivated area used for the experiment was 81 m². The various parameters such as moisture distribution in the soil, temperature variation in the field, number of female flowers developed, yield and yield attributing characters like number of fruits per plant, fruit length, fruit girth and water use efficiency of the micro sprinkler were evaluated.

The soil moisture content at the surface and at 30 cm depth from the surface was determined from each plot one hour after irrigation by gravimetric method. Average soil moisture retained was much higher for the treatment with paddy straw mulch which favorably attributed to the plant growth and yield. The mean moisture content on weight basis with paddy straw mulch at the surface and at 30 cm depth was 20.3% and 9.47% respectively. The temperature within the field varied from 27⁰C and 37⁰C for measurements recorded at 2.30 pm for the entire growing period of the crop. Maximum number of flowers was observed in treatment with paddy straw mulch and first female flower was also found in the case with paddy straw and paper mulching.

The yield response was sensitive to different mulched treatments. Maximum yield of 6.75 kg/plant occurred from the treatment with 100% irrigation and paddy straw mulching and a minimum of 2.33kg/plant occurred from the treatment with 75% irrigation and no mulching. The yield obtained with paper mulching was also on par with paddy straw mulching. Hence, it can be stated that natural mulching along with micro sprinkler irrigation is the best alternative for the crop under study.

Maximum number of fruits (7 numbers) was obtained from the treatment with 100% and 75% irrigation with paddy straw mulch and also in 100% irrigation with paper mulching. The minimum number of fruits per plant obtained was 4 for treatment T3 (50% irrigation and no mulch) and T6 (50% irrigation and paper mulch). It was found that T4 (100% irrigation and paper mulch), T7 (100% irrigation and paddy straw mulch) and T8 (75% irrigation and paddy straw mulch) were statistically superior to all the other treatments.

Water Use Efficiency (WUE) was more in the treatments with low irrigation levels (T3, T5 and T9). The highest WUE obtained was 195.56 kg/ha/mm from the treatment T9 (50% irrigation and paddy straw mulching) and the lowest WUE obtained was 72.41 kg/ha/mm from T1 (100% irrigation and no mulching). This low WUE was due to the fact that there were no mulching effect and 100% irrigation was also applied. Statistical analysis was performed using MSTAT software and it is seen that all the observations except fruit length and fruit girth showed significant difference between treatments. Hence, it is concluded that micro sprinkler irrigation along with mulch helps to achieve the twin objectives of efficient utilization of available water and conservation of soil moisture.

REFERENCES

REFERENCES

- Amir, I. and Dag, I. 1993. Lateral and longitudinal wetting patterns of very low energy moving emitters. *Irrig. Sci.* 13(4): 183-187.
- Anwar, A. and Aswani, K. 1980. Micro irrigation system- Past, present and future. In: Singh, H.P., Kaushish, S.P., Aswani, K., Murthy, C.S., and Samuel, J.C. (eds.), *Micro irrigation* (2001). Central Board of Irrigation and Power, New Delhi, pp: 1-17.
- Anzalone, A., Cirujeda, A., Aibar, J., Pardo, G., and Zaragoza, C. 2010. Effect of biodegradable mulch materials on weed control in processing tomatoes. *Weed Technol.* 24(3): 369-377.
- Aref, A., Abdulbaki and John, R.S. 1996. Heiry vetch mulch favourably impacts yield of processing tomatoes. *Hort. Sci.* 31(3); 338-340.
- Armstrong, F. and Wilson, V.T. 1982. Moisture distribution in stratified soils under a trickle source. In: ASAE Summer Meeting, University of Wisconsin, Madison, WI, USA. American Society of Agricultural Engineers, St Joseph, MI, USA. Paper No. 82.2061. pp. 1-42.
- Arulkar, K.P., Sarode, S.C., and Bhuyar, R.C. 2008. Wetting pattern and salt distribution in drip and micro sprinkler irrigation. *Agric. Sci. Digest* 28(2).
- ASAE.1991. Procedure for sprinkler distribution testing for research purpose. ASAE standard: S 330.1. St.Joseph, M.I, USA
- ASAE. 1997. Procedure for sprinkler testing and performance recording. ASAE standard: S 398.2. St.Joseph, MI, USA.
- Asin, L., Torres, E., and Vilardell, P. 2011. Orchard cooling with overtree micro sprinkler irrigation to increase fruit russet on ‘Conference’ pear. *Acta Horticulturae* No 909.

- Asokaraj, N. 2001. Micro irrigation- need of the 21st century for conserving India's water resources. In: Singh, H.P., Kaushish, S.P., Aswani, K., Murthy, C.S., and Samuel, J.C. (eds.), *Micro irrigation* (2001). Central Board of Irrigation and Power, New Delhi, pp: 52-62.
- Awari, H.W., Jadhav, S.N., and Gore, A.K.. 2001. Effect of irrigation frequency and irrigation level on yield of chilli under micro sprinkler irrigation. In: Singh, H.P., Kaushish, S.P., Aswani, K., Murthy, C.S., and Samuel, J.C. (eds.), *Micro irrigation* (2001). Central Board of Irrigation and Power, New Delhi, pp: 52-62.
- Barragan, J., Bralts, V., and Wu, I.P. 2006. Assessment of emission uniformity for micro irrigation design, *Biosystems Engng.* 93(1): 89-97.
- Barragan, J., Cots, L., Monserrat, J., Lopez, R., and Wu, I.P. 2010. Water distribution uniformity and scheduling in micro irrigation systems for water saving and environmental protection. *Biosystems Engng.* 107(3); 202-211.
- Barret, J.W.H. 1979. The use of modern irrigation methods to reduce water supply requirements. In: Irrigation efficiency seminar.15-17 May. Australian National Committee, International commission on irrigation and drainage, Sydney, pp. 483-491.
- Barth, H.K. 1999. Sustainable irrigation through a new sub-soil irrigation system. *Agric. Water Mgmt.* 40(2-3): 283-290.
- Batra, B.R., Malik, Y.S., and Pandit, M.L. 1985. Evaluation of different mulching materials in okra production under dry farming conditions. *Agric. Sci. Digest India* 5: 8-9.
- Berihun, B. 2011. Effect of mulching and amount of water on the yield of tomato under drip irrigation. *J. Hort. and For.* 3(7): 200-206.

- Bhattacharya, R.K. and Rao, M.V.N. 1985. Water requirement, crop coefficient and water use efficiency of robusta banana under different soil covers and soil moisture regimes. *Scientia Horticulturae* 25: 253-264.
- BIS 1987. IS 12232: Irrigation Equipment- Rotating sprinkler: part 1. Design and operational requirements. Bureau of Indian Standards.
- Boman, B.J. 1989. Distribution patterns of micro irrigation spinner and spray emitters. *Trans. ASAE*. 5(1): 50-56.
- Boman, B.J. 1999. Micro tubing effects on micro sprinkler discharge rates, *Transactions of ASAE*, 34(6): 2453-2458.
- Boman, B.J. and parsons, L.R. 1999. Micro sprinkler experiments in Florida citrus. *Appl. Engng. in Agric.* 15(5): 465-475.
- Bucks, D.A. and Davis, S. 1986. Historical development. In: Nakayama, F.S. and Bucks, D.A. (eds.), Trickle irrigation for crop production. Elsevier Sci. Publ. New York, 9: 1-26
- Castilla, P.D., Hernandez, J., Quesada, F.M., and Morales, M.I. 1994. Proc. 13th International Congress on Plastics in Agriculture.
- Ceres, D.G.C.A., Tarlei, A.B., and Rod, J.S. 2009. Characterization of the micro tube emitters used in a novel micro sprinkler. *Irrig. Sci.* 27(3): 209-214.
- Chakraborty, R.C. and Sadhu, M.K. 1994. Effect of mulch type and colour on growth and yield of tomato. *Indian J. Agric. Sci.* 64: 608-612.
- Chaya, L.A. and Hills, D.J. 1991. Droplet size and drift potential from micro sprayer emitters. *Trans. ASAE*. 346:2132-2421.
- Christiansen, J.E. 1942. Hydraulics of sprinkling systems for irrigation. *Trans. ASAE*, 107: 221-239.

- Cigdem, D., Umran, E., Senih, Y., Burak, N.C., and Arif, S. 2008. Effects of different irrigation levels on the vegetative growth, flower bud formation and fruit quality of sweet cherry in western part of Turkey. *J. Fd, Agric. and Environ.* 6(2): 173-177.
- Conellan, G. 1994. Measuring performance of turf irrigation systems. Proc. of National Conference. Australian irrigation association, 17-19 may. Sydney.
- Cuenca, R.H. and Richard, H. 1989. Irrigation system design- An Engineering approach. Prentice- Hall, Eaglewood Cliffs. New Jercey, USA, 552p.
- Dadio, C. and Wallender, W.W. 1985. Droplet size distribution and water application with low pressure sprinklers. *Trans. ASAE.* 28(2): 511-516.
- Dalton, P. and Raine, S. 2000. Technical issues in water use efficiency. In: Measures of irrigation performance and water use efficiency. http://www.ncea.org.au/downloads/rwue_rdereview.pdf.
- Davely, I., Boay, M., Zohar, Y., Rolland, L., Halevy, M., and Celestre, P. 1973. Trickle irrigation. Food and Agriculture Organization of the United Nations, Rome. FAO Paper 14.
- Davies, D.L., Evans, R.G., Campbell, G.S., and Kroeger, M.W. 1998. Undertree sprinkling for low temperature modification in apple orchards. *Trans. ASAE.* 31(2): 789-795.
- Kumar, D., Pandey, V., and Nath, V. 2008. Effect of organic mulches on moisture conservation for rainfed turmeric production in mango orchard. *Indian J. Soil Cons.* 36(3): 188-191.
- Dixit, C.K. and Majumdar, A.M. 1995. Effect of mulching on water use efficiency, yield and quality of potato (*Solanum tuberosum* L.). *Haryana J. Hortic. Sci.* 24: 286-291.

- Emmert, E.M. 1969. Black polyethylene for mulching vegetables. *J. Am. Soc. of Hortic. Sci.* 69: 164-170.
- Ertek, A. 1998. The possibilities of irrigation of cotton with drip systems. Ph.D thesis, Irrigation and Drain Engineering Department, Institute of Natural Science, Çukurova University, Adana, Turkey, 140 pp.
- Farbman, M. 1992. Micro irrigation systems: self regulation emitter- principles and system designs. *Water and Irrigation Revies* 12(2): 30-32.
- Farghale, M.A. 1997. Effect of plastic mulches on off season egg plant production. *Assiut J. agric. Sci.* 25(3): 97-112.
- Farias, L, J. and Orozco, S.M. 1997. Effect of polyethylene mulch colour on aphid populations, soil temperature, fruit quality and yield of watermelon under tropical conditions. *New Zealand J. of Hort. Sci.* 25(4); 369-374.
- Free, G.R. and Bay, C. 1990. Effects of plastic mulch on the growth, maturity and yields of corn. *Proc. Soil Science Society*, 461-464.
- Ghosh, S.N. and Ranjan, K.T. 2007. Effect of mulching on soil moisture, yield and quality of ber (*Zizipus mauritiana*). *Indian J. Soil Cons.* 35(3): 246-248.
- Bai, G.E.B. 1997. Effect of drip irrigation along with two colours of plastic mulching on the growth and yield of Brinjal. Unpublished M Tech Thesis. KCAET, Tavanur, Kerala, India.
- Gollifer, D.E. 1993. Effects of application of mulch and K on *Capsicum annum*. *Guinea J. Agric.* 36: 22-29.
- Gupta, J.P. and Gupta, G.N. 1987. Response of tomato and okra crops to irrigation and mulch in arid region of India. *Agrochemica* 31: 183-202.

- Gustafson, C.D., March, A.W., Branson, R.L., and Davis, S. 1974. Drip irrigation worldwide. Proceedings of the second International drip irrigation congress. San Diego, California.
- Gutal, G.B., Bhilare, R.M., and Takte, R.L. 1994. Mulching effects on yield of tomato crop. Proceedings of the international Agricultural Engineering Conference, 3:883-887.
- Hall, B.J. 1985. History of drip/trickle irrigation. Proceedings of the third International Drip/Trickle Irrigation Congress, Fresno, California.
- Hart, W.E. 1972. Subsurface distribution of non-uniformity applied surface waters. *Trans. ASAE* 15: 656-661.
- Hassan, S.A., Ramlan, Z.A., and Inon, S. 1994. Influence of K and mulching on growth and yield of chilli. *Acta Horticulturae* 369: 311-317
- Himelrick, D.G., Dozier, W.A., and Akridge, J.R. 1993. Effect of mulch type in annual hill strawberry plasticulture systems. *Acta Horticulturae* 348: 207-212.
- Hochmuth, Choi, C.Y., and Surez-Ray, E.M. 2004. Yield and yield attributes of water melon as influenced by mulching. *Trans. ASAE* 47(6): 1943-1951.
- Holzapfel, E., Jara, J., and Martinez, G. 2011. Evaluation of a micro sprinkler irrigation system at an apple farm in the central valley of Chile. *Acta Horticulturae* No 889.
- Howell, T.A., Stevenson, D.S., and Summerland, B.C. 1981. Design and operation of trickle (drip) system. In: Jenson, M.C. (ed.), Design and operation of farm irrigation systems. American Society of Agricultural Engineers, USA. ASAE Monograph 3. pp. 663–713.

- Jadhav, P.P., Nikam, S.P., Sinha, A.K., and Kate, A.E. 2011. Effect of nozzle size and operating pressure on performance of medium volume rain gun. *J. Agric. Engng.* 4(1): 97-99.
- James, L.G. 1988. Principles of farm irrigation system design. John Wiley, New York.
- Jensen, M.E. 1983. Design and operation of farm irrigation systems. ASAE Monograph 3, St. Joseph, MI, USA.
- Jobling G.A. 1973. Trickle irrigation design manual. Parts 1–2. New Zealand Agricultural Engineering Institute, Lincoln College, Canterbury, New Zealand, 88 pp.
- Jose, C.S. 2001. Micro irrigation in fruit crops in India. In: Singh, H.P., Kaushish, S.P., Aswani, K., Murthy, C.S., and Samuel, J.C. (eds.), *Micro irrigation* (2001). Central Board of Irrigation and Power, New Delhi, pp: 280-293.
- Kanber, R. 1999. Irrigation [Lecture notes]. Faculty of Agriculture, Çukurova University, Adana, Turkey. Lecture Book. No. 174(52), 530 pp.
- Keller, J. and Karmeli, D. 1975. Trickle irrigation design (1st ed.). Rainbird Sprinkler Manufacturing Corporation, Glendora, USA, 131 pp.
- Koni, S.B. 1983. A study on crop residues management in Chilli (Capsicum annum L.) production. M.Sc. (Agri) Thesis, University of Agricultural Sciences, Dharwad, Karnataka, India.
- Koumonov, K.S., Hopmans, J.W., Schwankl, L.J., Andreu, L., and Tuli, A. 1997. Application efficiency of micro sprinkler irrigation of almond trees. *Agric. Water Mgmt.* 34(3): 247-263.
- Kulkarni, S. Y. 1987. Sprinkler and drip irrigation system, *Sinchan* 6(3): 56-61.

- Lal, R. 1978. Influence of within and between row mulching on soil temperature, soil moisture, root development and yield of maize in tropical soil. *Field Crop Res.* 1: 127-139.
- Lourduraj, A.C. and Chattopadhyay, P.K. 1996. Influence of mulch on soil temperature, moisture and their effects on growth and yield of custard apple. *Advances in Plant Sci.* 7(2): 314-318.
- Mandal, A. and Chattopadhyay, P.K. 1999. Influence of mulch on soil temperature, moisture and their effects on growth and yield of custard apple. *Adv. in Plant Sci.* 7(2): 314-318.
- Mane, T.A., Khade, K.K., Ghugare, R.V., Pawar, H.K., and Magar, S.S. 1987. Comparative performance of sprinkler and furrow methods of irrigation on the yield of chilli. Paper: National seminar on drip and sprinkler methods adoption. April 10-11. Rahuri, Maharashtra.
- Mayalagu, K. 1983. Influence of different soil amendments on the physical properties of a heavy black soil and yield of groundnut TMV-7 in the Periyar Vaigai command area. *Madras Agric. J.* 70: 304-308.
- Merriam, J.L. and Keller, J. 1978. Farm irrigation system evaluation: a guide for management. Utah State University, Logan, USA, pp. 125-144.
- Mostaghimi, S., Mitchell, J.K., and Lembke, W.D. 1981. Effect of discharge rate on distribution of moisture in heavy soils irrigated from a trickle source. ASAE Summer Meeting, University of Illinois, Urbana-Champaign, IL, USA. American Society of Agricultural Engineers, St Joseph, MI, USA. Paper No. 81.2081. pp. 1-14.
- Neilson, D., Neilson, G.H., Gregory, D., Forge, T., and Zebarth, B. 2008. Drainage losses of Water, N and P from micro irrigation systems in a young, high density apple planting. *Acta Horticulturae* No. 792.

- Oron, G. 1984. Yield of single versus twin-row trickle irrigated cotton. *Agric. Water Mgmt.* 9: 237-244.
- Pai, W. 1997. An assessment of hydraulic design of micro irrigation systems. *Agric. Water Mgmt.* 32(3): 275-284.
- Pandey, A.K., Chauhan, H.S., Singh, K.K., and Shukla, K.N. 1995. Distribution characteristics of micro sprinklers. F.R. Lamm (ed.), Proc. of the fifth int. Micro-irrigation Congress. 2-6 April. Orlando, Florida. Pp. 857-862.
- Patra, D.D., Ram, M., and Singh, D.V. 1994. Influence of straw mulching on fertilizer nitrogen use efficiency, moisture conservation and essential oil yield in Japanese mint. *Fertiliser Res.* 34(2): 135-139.
- Post, S., Peck, D.E., Brandlee, B.A., Sakovich, N.J., and Waddel, L. 1986. Evaluation of non-overlapping, low flow sprinklers. Drip/trickle irrigation in action. Proceedings of the third international Drip/Trickle irrigation congress. ASAE. St. Joseph, MI, USA, pp. 293-305.
- Pulekar, C.S., Jadhav, S.N., and Patil, B.P. 1996. Effects of irrigation and grass mulching on yield and economics of summer okra in Konkan. *J. Maharashtra Agric. Univ.* 18(2): 202-205.
- Quadir, M.A. 1995. Mulching effects on fruit yield of watermelon. *Agric. Sci. Digest* 12(1): 1-3.
- Rajput, R.K. and Singh, M. 1970. Efficiency of different mulches on conserving soil moisture in cotton. *Indian J. Agron.* 15: 41-45.
- Rao, S.S., Singh, Y.V., Regar, P.L., and Khem, C. 2010. Effect of micro irrigation on productivity and water use of cumin (*Cuminum cyminum*) at varying fertility levels. *Indian J. Agric. Sci.* 80(6).
- Ravinder, K and Srivastava, B.K. 1998. Influence of different mulches on flowering and fruit setting of winter tomato. *Crop Res.* 12: 174-176.

- Rolbiecki, R. 2007. The effect of Micro irrigation on yields of Zucchini (*Cucurbita pepo L.*) cultivated on a sandy soil in Central Poland. *Acta Horticulturae* 729: 325-329.
- Rose, N.E., Stofella, D.J., and Bryan, N.H. 1994. Growth and yield of bell pepper and winter squash grown with organic and living mulches. *J. Am. Soc. Hortic. Sci.* 119: 1193-1199.
- Sarkar, S., Goswamy, S.B., Mallick, S., and Nanda, M.K. 2008. Different indices to characterize water use pattern of micro sprinkler irrigated onion (*Allium cepa L.*). *Agric. Water Mgmt.* 95(5): 625-632.
- Satyendra, K. and Nangare, D.D. 2008. Optimization of Irrigation for Potato with micro sprinkler Irrigation System. *J. Agric. Engng.* 45(3).
- Satyendra, K., Imtiyaz, M., and Kumar, A. 2009. Studying the feasibility of using micro irrigation system for vegetable production in a canal command area. *Irrig. and Drain*, 58(1): 86-95.
- Senyigit, U. 1998. The effects of different irrigation methods and different nitrogen doses and forms on the yield and quality of watermelon. International Center for Advanced Mediterranean Agronomic Studies, Bari, Italy, 60 pp.
- Shinde, V.R. 1995. Water requirement and yield of chilli under micro irrigation system and mulches. M Tech thesis, M P K V Rahuri, Maharashtra.
- Shrivasthava, P.K., Parikh, M.M., Sawani, N.G., and Raman, S. 1999. Effect of drip irrigation and mulching on tomato yield. *Agric. Water Mgmt.* 25: 179-184.
- Singh, H. and Singh, K.K. 1990. Technologies for combating desertification. <http://sdnp.delhi.nic/resources/desert/unccd/chap-6-iii.pdf>.

- Singh, H.P. 2001. Emerging scenario of micro irrigation in India. In: Singh, H.P., Kaushish, S.P., Aswani, K., Murthy, C.S., and Samuel, J.C. (eds.), *Micro irrigation* (2001). Central Board of Irrigation and Power, New Delhi, pp: 18-30.
- Singh, R., Sharma, R.R., Kumar, A., and Singh, D.B. 2009. Package of practices for strawberry cultivation with modern techniques under north Indian plains. *Acta Horticulturae* 842: 607-610.
- Sivanappan, R.K. 2001. Micro irrigation in fruits crops for improving productivity. In: Singh, H.P., Kaushish, S.P., Aswani, K., Murthy, C.S., and Samuel, J.C. (eds.), *Micro irrigation* (2001). Central Board of Irrigation and Power, New Delhi, pp: 240-244.
- Smajstrala, A.G. 1995. Florida in 1994- irrigation survey overall growth a continuing trend. *Irrig. J.* 451: 27-42.
- Sood, B.R. and Sharma, V.K. 1996. Effect of intercropping and planting geometry on the yield and quality of forage maize. *Forage Res.* 24(4): 190-192.
- Srinivas, K. and Hedge, D.M. 1994. Effect of mulches and cover crops on Robusta banana. *Indian J. Agric. Sci.* 64(1): 779-782.
- Suseela, P., visalakshi, K.P., Prameela, K.P., bridgit, T.K., and Abraham, M. 2006. KAU micro sprinkler. Kerala Agricultural university, Thrissur, Kerala, pp: 1-9.
- Taber, H.G. 1993. Early muskmelon production with wavelength selective and clear plastic mulches. *Hortic. Technol.* 3(1): 78-80.
- Tekinel, O., Kanber, R., Onder, S., Baytorun, N., and Batu, R. 1989. The effects of trickle and conventional irrigation methods on some crops yield and water use efficiency under Çukurova conditions. *Irrigation theory and*

practice. Proceedings of the international conference. University of Southampton, London, UK. pp. 641–651.

Tomar, A.S. 2003. Study on growth, yield, and water use and shoot-root characteristics of bush snap bean as influenced by micro irrigation and surface method of irrigation. *Indian J. Soil Cons.* 31(2): 157.

Vethomani, P.I. and Balakrishnan, R. 1990. Studies on the influence of herbicide, nitrogen and mulching on the nutrient uptake of okra (cv. MDU-1). *Indian J. Hortic.* 7: 33-238.

Walker, W.R. 1993. SIRMOD- Surface Irrigation Simulation Software and Manual. Ver.2.1. Utah State University, Logan.

Walker, W.R. and Skogerboe, G.V. 1987. Surface irrigation- Theory and Practice. Prentice hall, New Jersey, USA.

Wamble, R.L. and Farrar, S.L. 1983. Yield and quality of furrow and trickle irrigation Hob. (*Humulus lupulus* L.) in Washington State. *Agric. Water Mgmt.* 7: 457–470.

Weon, T.J., Bong, S.C., Samy, A.M., El-azeem, A., and Yong, S.O. 2011. Effects of green manure crops and mulching technology on reduction in herbicide and fertilizer use during rice cultivation in Korea. *African J. Biotech.* 10(1): 1-8.

Willardson. 1972. Attainable irrigation efficiencies. *J.irrig. Drainage. Div.* 98(2): 239-246.

Yavuz, M.Y. 1993. The effects of different irrigation methods on the yield and water use efficiency of cotton. Ph D thesis, Irrigation And Drainage Engineering Department, Institute of Natural Science, Çukurova University, Adana, Turkey, 196 pp.

APPENDICES

Appendix- I

Catch-can data (Amount of water obtained in catch cans)

Pressure 1.0 kg/cm²

Width of cut 0.5 mm

Grid point	Catch (ml)	Grid point	Catch (ml)	Grid point	Catch (ml)
A1	0	H2	28	F4	38
B1	0	I2	0	G4	233
C1	0	A3	17	H4	119
D1	0	B3	76	I4	109
E1	✧	C3	255	A5	95
F1	226	D3	50	B5	73
G1	91	E3	0	C5	13
H1	33	F3	0	D5	15
I1	5	G3	0	E5	21
A2	0	H3	0	F5	49
B2	638	I3	0	G5	0
C2	92	A4	0	H5	0
D2	82	B4	0	I5	0
E2	105	C4	112	A6	0
F2	73	D4	71	B6	0
G2	617	E4	62	C6	0

Pressure 1.0 kg/cm²

Width of cut 1.0 mm

Grid point	Catch (ml)	Grid point	Catch (ml)	Grid point	Catch (ml)	Grid point	Catch (ml)
A1	0	F2	129	B4	0	G5	144
B1	0	G2	379	C4	55	H5	40
C1	0	H2	167	D4	25	I5	4
D1	0	I2	114	E4	14	A6	0
E1	✧	A3	56	F4	4	B6	0
F1	116	B3	27	G4	419	C6	0
G1	60	C3	227	H4	165	D6	0
H1	67	D3	135	I4	88	E6	0
I1	65	E3	57	A5	84	F6	0
A2	6	F3	19	B5	600	G6	0
B2	411	G3	1	C5	309	H6	0
C2	243	H3	0	D5	72	I6	0
D2	192	I3	0	E5	33		
E2	152	A4	0	F5	315		

Pressure 1.0 kg/cm²

Width of cut 1.5 mm

Grid point	Catch (ml)	Grid point	Catch (ml)	Grid point	Catch (ml)	Grid point	Catch (ml)
A1	0	F2	166	B4	0	G5	209
B1	0	G2	472	C4	98	H5	176
C1	0	H2	216	D4	115	I5	128
D1	0	I2	84	E4	41	A6	0
E1	✂	A3	86	F4	0	B6	0
F1	154	B3	141	G4	299	C6	0
G1	98	C3	386	H4	199	D6	0
H1	148	D3	201	I4	229	E6	0
I1	163	E3	21	A5	123	F6	0
A2	154	F3	5	B5	412	G6	0
B2	362	G3	10	C5	381	H6	0
C2	275	H3	0	D5	223	I6	0
D2	233	I3	0	E5	212		
E2	217	A4	0	F5	209		

Pressure 1.0 kg/cm²

Width of cut 2.0 mm

Grid point	Catch (ml)	Grid point	Catch (ml)	Grid point	Catch (ml)	Grid point	Catch (ml)
A1	0	F2	108	B4	0	G5	180
B1	0	G2	484	C4	166	H5	144
C1	0	H2	230	D4	1821	I5	124
D1	0	I2	142	E4	120	A6	0
E1	✂	A3	148	F4	60	B6	0
F1	202	B3	140	G4	340	C6	0
G1	116	C3	406	H4	292	D6	0
H1	112	D3	188	I4	284	E6	0
I1	108	E3	60	A5	212	F6	0
A2	100	F3	44	B5	426	G6	0
B2	402	G3	64	C5	264	H6	0
C2	278	H3	0	D5	220	I6	0
D2	220	I3	0	E5	190		
E2	150	A4	0	F5	438		

Appendix- II

a. Pressure - discharge relationship of FDMS

Emitter size		Pressure (kg/cm ²)	Discharge (lph)	Emitter size		Pressure (kg/cm ²)	Discharge (lph)
l (mm)	b (mm)			l (mm)	b (mm)		
4	0.5	0.5	30.63	4	1.5	0.5	44.52
		1.0	39.15			1.0	55.00
		1.5	46.95			1.5	67.29
		2.0	53.73			2.0	75.57
4	1.0	0.5	38.97	4	2.0	0.5	50.81
		1.0	48.53			1.0	59.55
		1.5	55.00			1.5	74.07
		2.0	59.55			2.0	90.66

b. Wetted radius of FDMS at different operating pressures

Emitter size		Pressure (kg/cm ²)	Wetted radius (m)	Emitter size		Pressure (kg/cm ²)	Wetted radius (m)
l (mm)	b (mm)			l (mm)	b (mm)		
4	0.5	0.5	2.31	4	1.5	0.5	2.27
		1.0	2.42			1.0	2.36
		1.5	2.46			1.5	2.40
		2.0	2.51			2.0	2.46
4	1.0	0.5	2.00	4	2.0	0.5	2.32
		1.0	2.28			1.0	2.47
		1.5	2.29			1.5	2.54
		2.0	2.34			2.0	2.60

c. Mean application depth of FDMS at different operating pressures

Emitter size		Pressure (kg/cm ²)	D _a (mm/hr)	Emitter size		Pressure (kg/cm ²)	D _a (mm/hr)
l (mm)	b (mm)			l (mm)	b (mm)		
4	0.5	0.5	7.8	4	1.5	0.5	11.1
		1.0	8.7			1.0	13.9
		1.5	10.2			1.5	15.1
		2.0	11.1			2.0	15.9
4	1.0	0.5	12.6	4	2.0	0.5	11.2
		1.0	12.0			1.0	12.8
		1.5	14.8			1.5	17.7
		2.0	16.1			2.0	17.3

d. Mean discharge of the FMMS at various operating pressures

Emitter size		Pressure (kg/cm ²)	Discharge (lph) b (mm)	Emitter size		Pressure (kg/cm ²)	Discharge (lph)
l (mm)	b (mm)			l (mm)	b (mm)		
4	0.5	0.5	21.7	4	1.5	0.5	45.6
		1.0	30.1			1.0	53.3
		1.5	38.4			1.5	59.9
		2.0	45.9			2.0	64.4
4	1.0	0.5	27.7	4	2.0	0.5	48.9
		1.0	31.6			1.0	56.0
		1.5	35.8			1.5	64.6
		2.0	49.9			2.0	74.6

e. Wetted radius of FMMS at various operating pressures

Emitter size		Pressure (kg/cm ²)	Wetted radius (m)	Emitter size		Pressure (kg/cm ²)	Wetted radius (m)
l (mm)	b (mm)			l (mm)	b (mm)		
4	0.5	0.5	1.4	4	1.5	0.5	2.0
		1.0	1.6			1.0	2.2
		1.5	1.8			1.5	2.3
		2.0	2.1			2.0	2.5
4	1.0	0.5	1.5	4	2.0	0.5	2.1
		1.0	1.7			1.0	2.4
		1.5	1.9			1.5	2.5
		2.0	2.2			2.0	2.8

f. Mean application depth of FMMS at various operating pressures

Emitter size		Pressure (kg/cm ²)	D _a (mm/h)	Emitter size		Pressure (kg/cm ²)	D _a (mm/h)
l (mm)	b (mm)			l (mm)	B (mm)		
4	0.5	0.5	15.6	4	1.5	0.5	15.9
		1.0	16.52			1.0	15.3
		1.5	17.6			1.5	15.2
		2.0	14.0			2.0	14.0
4	1.0	0.5	16.8	4	2.0	0.5	16.7
		1.0	14.9			1.0	12,5
		1.5	13.7			1.5	13.4
		2.0	11.5			2.0	12.7

g. Wetted radius of SMMS at various operating pressures

Emitter size		Pressure (kg/cm ²)	Wetted radius (m)	Emitter size		Pressure (kg/cm ²)	Wetted radius (m)
l (mm)	b (mm)			l (mm)	b (mm)		
4	0.5	0.5	1.62	4	1.5	0.5	2.02
		1.0	1.68			1.0	2.27
		1.5	1.81			1.5	2.48
		2.0	1.97			2.0	2.75
4	1.0	0.5	1.58	4	2.0	0.5	2.37
		1.0	1.68			1.0	2.52
		1.5	1.75			1.5	2.61
		2.0	2.2			2.0	2.91

h. Mean discharge of SMMS at various operating pressures

Emitter size		Pressure (kg/cm ²)	Discharge (lph)	Emitter size		Pressure (kg/cm ²)	Discharge (lph)
l (mm)	b (mm)			l (mm)	b (mm)		
4	0.5	0.5	58.0	4	1.5	0.5	63.7
		1.0	64.1			1.0	82.4
		1.5	71.4			1.5	92.9
		2.0	79.4			2.0	110.4
4	1.0	0.5	61.6	4	2.0	0.5	77.5
		1.0	77.9			1.0	87.5
		1.5	84.06			1.5	100.2
		2.0	89.04			2.0	110.4

i. Mean application depth of SMMS at various operating pressures

Emitter size		Pressure (kg/cm ²)	Da (mm/h)	Emitter size		Pressure (kg/cm ²)	Da (mm/h)
l (mm)	b (mm)			l (mm)	b (mm)		
4	0.5	0.5	28.2	4	1.5	0.5	17.6
		1.0	28.8			1.0	21.2
		1.5	27.9			1.5	19.4
		2.0	26.6			2.0	30.46
4	1.0	0.5	31.7	4	2.0	0.5	17.7
		1.0	35.3			1.0	17.9
		1.5	35.2			1.5	19.1
		2.0	31.8			2.0	18.7

Appendix- III

Statistical analysis of field study of the micro sprinkler

Experiment Model: Randomized Complete Block Design

a. Effect of micro sprinkler treatments on number of female flowers per plant

ANALYSIS OF VARIANCE TABLE							
K value	Source	DF	SS	MS	F value	Probability	Remarks
1	Replication	2	2.000	1.000	0.5455	0.0261	S
2	Factor A	8	45.333	5.667	3.0909		
-3	Error	16	29.333	1.833			
	Total	26	76.667				

b. Effect of micro sprinkler treatments on number of fruits per plant

ANALYSIS OF VARIANCE TABLE							
K value	Source	DF	SS	MS	F value	Probability	Remarks
1	Replication	2	0.222	0.111	0.0930		
2	Factor A	8	25.333	3.167	2.6512	0.0461	S
-3	Error	6	19.111	1.194			
	Total	26	44.667				

c. Effect of micro sprinkler treatments on fruit length

ANALYSIS OF VARIANCE TABLE							
K value	Source	DF	SS	MS	F value	Probability	Remarks
1	Replication	2	3.059	1.529	0.7942	0.1214	NS
2	Factor A	8	30.061	3.758	1.9515		
-3	Error	16	30.808	1.926			
	Total	26	63.927				

d. Effect of micro sprinkler treatments on fruit girth

ANALYSIS OF VARIANCE TABLE							
K value	Source	DF	SS	MS	F value	Probability	Remarks
1	Replication	2	5.281	2.640	0.6523		NS
2	Factor A	8	12.021	1.503	0.3712		NS
-3	Error	16	64.766	4.048			
	Total	26	82.067				

e. Effect of micro sprinkler treatments on yield

ANALYSIS OF VARIANCE TABLE							
K value	Source	DF	SS	MS	F-value	Probability	Remarks
1	Replication	2	2.838	1.419	4.3172	0.0317	S
2	Factor A	8	29.392	3.674	11.1797	0.0000	S
-3	Error	16	5.258	0.329			
	Total	26	37.488				

ABSTRACT

HYDRAULICS AND FIELD PERFORMANCE OF A NOVEL MICRO SPRINKLER

By

SOUMYA RANI, T

(2010 - 18 - 106)

ABSTRACT OF THE THESIS

**Submitted in partial fulfilment of the
requirement for the degree of**

MASTER OF TECHNOLOGY

IN

AGRICULTURAL ENGINEERING

(Soil and Water Engineering)

Faculty of Agricultural Engineering & Technology

Kerala Agricultural University



DEPARTMENT OF LAND & WATER RESOURCES AND CONSERVATION ENGINEERING

KELLAPAJI COLLEGE OF AGRICULTURAL ENGINEERING AND TECHNOLOGY

TAVANUR - 679573, MALAPPURAM

2012

ABSTRACT

This thesis work was undertaken to study the hydraulics and field performance of a simple and novel micro sprinkler developed by a farmer Mr. Avaran, M of Malappuram District, Kerala. It is made by fusing one end of a 3mm diameter, 4 cm long LDPE micro tube and making an incision just below the fused end. The manually made micro sprinkler samples of four different dimensions were used for the experiment. The micro sprinklers were tested for their hydraulic performance in the laboratory under four different pressures viz. 0.5, 1.0, 1.5 and 2.0 kg/cm². The performance parameters of the micro sprinklers considered for the study were discharge, wetted radius, mean application depth, Christiansen's uniformity coefficient, coefficient of variation, distribution characteristics and soil moisture distribution pattern. The farmer developed micro sprinkler was found suitable to irrigate most of the perennial and vegetable crops of the study region. However, the micro sprinkler was showing considerable variability in discharge, wetted radius and application depth. To solve the deficiency of the farmer developed micro sprinkler, it was decided to manufacture standardised micro sprinklers through plastic injection moulding. The hydraulic performance of the industry manufactured micro sprinkler was not promising as revealed by the laboratory results and needed further refinement. A preliminary investigation has led to the conclusion that if moulding and cutting is done through two separate manufacturing processes better results can be brought out.

Further, a field study was carried out with the farmer developed micro sprinkler to evaluate its field performance for the crop cucumber, with different levels of irrigation and mulching at the instructional farm, KCAET Tavanur. Randomised Complete Block Design was used for the study with 9 treatments and 3 replications. The various field performance parameters such as moisture distribution in the soil, temperature variation of the soil, number of female flower emergence, yield and yield

attributing characteristics viz. number of fruits per plant, fruit length, fruit girth and water use efficiency of the crop were evaluated. The micro sprinkler with 100% irrigation level with paddy straw mulching has been emerged as the best treatment for maximizing yield of cucumber in sandy loam soil and for the climatic condition of the region where experiment was carried out. Looking from the yield and water use efficiency angles together, the best treatment was 75% irrigation with paddy straw mulching. It has been concluded that this simple and low cost micro sprinkler, despite its minor limitations, can be used effectively for irrigating most of the vegetable crops of Kerala.