

**DEVELOPMENT AND EVALUATION OF MODIFIED
ATMOSPHERE PACKED PASSION FRUIT
(*Passiflora edulis*)**

By

**R. MADHANA SUPRIYA
(2010-18-110)**

Thesis

Submitted in partial fulfilment
of the requirement for the award of degree of

Master of Technology

In

Agricultural Engineering

(Agricultural Processing & Food Engineering)



**Faculty of Agricultural Engineering and Technology
Kerala Agricultural University**

**Department of Post Harvest Technology and Agricultural Processing
KELAPPAJI COLLEGE OF AGRICULTURAL ENGINEERING AND TECHNOLOGY
TAVANUR – 679 573
KERALA.**

2012

DECLARATION

I hereby declare that this thesis entitled '**Development and Evaluation of Modified Atmosphere Packed Passion Fruit (*Passiflora edulis*)**' is a *bona-fide* record of research done by me during the course of research and that the thesis has not previously formed the basis for the award of any degree, diploma, associate ship, fellowship or other similar title of any other University or society.

Tavanur

Date: 5.09.12

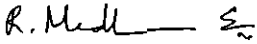
R.MADHANA SUPRIYA
(2010-18-110)

Dr. Sudheer. K.P.

Date : 5/9/12

Associate Professor

Department of Post Harvest Technology and Agricultural Processing

Kelappaji College of Agricultural Engineering and Technology

Tavanur, Malappuram, Kerala.

CERTIFICATE

Certified that this thesis entitled '**Development and Evaluation of Modified Atmosphere Packed Passion Fruit (*Passiflora edulis*)**' is a record of the research work done by Ms. R. MADHANA SUPRIYA (2010-18-110), under my guidance and supervision and that it has not previously formed the basis for the award of any degree, diploma, fellowship or associateship to her.

Tavanur

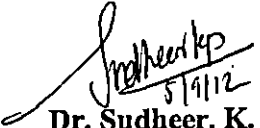
Dr. Sudheer. K. P

Chairman



Dr. K.P. SUDHEER
Associate Professor
Dept. of Post Harvest Technology
KCAET, Tavanur
Kerala - 679 573

CERTIFICATE

We, the undersigned, members of the Advisory Committee of Miss. **Madhana Supriya, R.**, a candidate for the degree of Master of Technology in Agricultural Engineering majoring in Agricultural Processing and Food Engineering agree that the thesis entitled "**Development and evaluation of Modified Atmosphere Packed Passion Fruit (*Passiflora edulis*)**" may be submitted by Miss. **Madhana Supriya, R.** in partial fulfillment of the requirement for the degree.

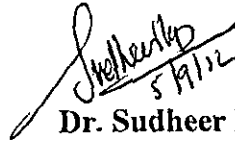

Dr. Sudheer K. P
Associate Professor
Dept. of PHT & AP
KCAET, Tavanur
(Chairman)



Dr. Santhi Mary Mathew
Professor and Head
Dept. of PHT & AP
KCAET, Tavanur
(Member)



Er. George Mathew
Associate Professor
Dept. of PHT & AP
KCAET, Tavanur
(Member)



Dr. Jayan. P.R.
Associate Professor and Head
Dept. of FPME
KCAET, Tavanur
(Member)

Dr. Sinija V.R
Associate Professor & Head
IICPT, Thanjavur
Tamil Nadu- 613005
(EXTERNAL EXAMINER)

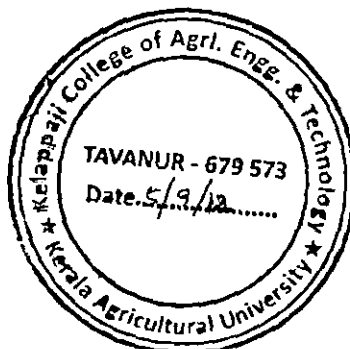

Acknowledgement

ACKNOWLEDGMENT

I bow to the lotus feet of 'God the Almighty' whose grace had endowed me the inner strength and confidence and blessed me with a helping hand at each step during this work.

I feel fortunate to be associated with my advisor **Dr. Sudheer K.P.**, *Associate Professor, Dept. of Post Harvest Technology and Agrl. Processing (PHT & AP), Kelapaji College of Agricultural Engineering and Technology (K.C.A.E.T), Tavanur.* He guided during the course of this research work with words of wisdom and training for patience. I am indebted for his sympathetic and kind co-operation provided for the accomplishment of this research work as a sympathetic and encouraging advisor.

It gives me an immense pleasure to thank **Dr. M. Sivaswami**, *Dean (Ag.Engg.), K.C.A.E.T, Tavanur* for providing me an opportunity to work on this project.

I am thankful to the worthy members of my advisory committee: **Dr. Santhi Mary Mathew**, *Prof. & Head, Dept. of PHT & AP, K.C.A.E.T, Tavanur*, **Er. George Mathew**, *Assoc. Prof., Dept. of PHT & AP, K.C.A.E.T, Tavanur*, **Dr. Jayan P. R.**, *Assoc. Prof. & Head, Dept of Farm Power Machinery & Energy, K.C.A.E.T, Tavanur* for their scholarly guidance.

My special thanks to **Mr. Hugh Douglas**, *AgriCoat Industries, England* and **Mr. Pramod**, *Farm Manager, Orange and Vegetable farms, Nellyampathy* for their helpful support by providing the raw materials required for this study.

I wish to acknowledge the assistance and encouragement from all PHT & AP staff, K.C.A.E.T, Tavanur.

I exploit this opportunity to thank **Mr. V.K. Asokan**, *Technical Supervisor (Gr.I)*, and **Mr. K. Aravindan**, *Technical Supervisor (Gr.I)*, of K.C.A.E.T, Tavanur, for their ardent spirit in aiding me.

I sincerely express my gratitude to also the other staff members of workshop, K.C.A.E.T, Tavanur, especially **Mr. Manohar Krishna, Mr. Muhammad, Mr. Ashraf, Mr. Sathyan, Mr. Mansoor** and all other technical staff of K.C.A.E.T for their help and co-operation during the conduct of this project.

I would also like to thank **Dr. S. Krishnan, Assoc. Prof, College of Horticulture, Vellanikkara** for his help and co-operation for doing the statistical analysis as a part of the research work.

I am highly courteous to **Er. Jishitha Ravindran, Er. Sunitha C.P** and **Er. Anu S Chandran, M.Tech** students for their constant timely help, uninterrupted words of encouragement and sincere advices during the research work.

I express my thanks to **Er. Pritty S Babu, Er. Pavithran** and **Er. Praveen Subhahar** for their willing help and co- operation.

I am deeply grateful for the financial support received from the Kerala Agricultural University, who awarded me a Junior Fellowship.

Above all I am greatly indebted to my parents and **Ms. Reshmi**, for the moral support, constant encouragement, affectionate concern and prayers without which I could not have completed this work. I am thankful to all those, who helped me through their prayers.

I am thankful to **all those**, who directly or indirectly helped me.

I once again bow my head to **Him** who had been constantly present with me during my work and for invigorating, enlightening and making me confident and optimistic throughout my life.



R.Madhana Supriya

LIST OF TABLES

Table No.	Title	Page No.
2.1	Nutritive value of passion fruit per 100 gram of the pulp	8
2.2	Classification of waxes	18
4.1	Change in PLW of uncoated fruits	43
4.2	Change in PLW of fruits in ambient storage	45
4.3	Change in TSS of uncoated fruits	47
4.4	Change in TSS of fruits in ambient storage	49
4.5	Change in acidity of uncoated fruits	51
4.6	Change in acidity of fruits kept in ambient storage	53
4.7	Variation in greenness (a) of bee wax coated fruits	55
4.8	Variation in lightness (L) of uncoated fruits	57
4.9	Variation in yellowness (b) of uncoated fruits	59
4.10	Variation in greenness (a) of commercial wax coated fruits	60
4.11	Variation in colour parameters of fruits kept in ambient storage	62
4.12	Change in pulp m.c of bee wax coated fruits	63
4.13	Change in pulp m.c of commercial wax coated fruits	65
4.14	Change in pulp m.c of fruits kept in ambient storage	66
4.15	Change in peel m.c of bee wax coated fruits	67

CONTENTS

Chapter	Title	Page No.
	LIST OF TABLES	viii
	LIST OF FIGURES	x
	LIST OF PLATES	xi
	LIST OF ANNEXURES	xii
	SYMBOLS AND ABBREVIATIONS	xiii
I.	INTRODUCTION	1
II.	REVIEW OF LITERATURE	5
III.	MATERIALS AND METHODS	25
IV.	RESULTS AND DISCUSSION	36
V.	SUMMARY AND CONCLUSION	80
	REFERENCES	84
	APPENDIX	94
	ABSTRACT	103

LIST OF TABLES

Table No.	Title	Page No.
2.1	Nutritive value of passion fruit per 100 gram of the pulp	8
2.2	Classification of waxes	18
4.1	Change in PLW of uncoated fruits	43
4.2	Change in PLW of fruits in ambient storage	45
4.3	Change in TSS of uncoated fruits	47
4.4	Change in TSS of fruits in ambient storage	49
4.5	Change in acidity of uncoated fruits	51
4.6	Change in acidity of fruits kept in ambient storage	53
4.7	Variation in greenness (a) of bee wax coated fruits	55
4.8	Variation in lightness (L) of uncoated fruits	57
4.9	Variation in yellowness (b) of uncoated fruits	59
4.10	Variation in greenness (a) of commercial wax coated fruits	60
4.11	Variation in colour parameters of fruits kept in ambient storage	62
4.12	Change in pulp m.c of bee wax coated fruits	63
4.13	Change in pulp m.c of commercial wax coated fruits	65
4.14	Change in pulp m.c of fruits kept in ambient storage	66
4.15	Change in peel m.c of bee wax coated fruits	67

4.16	Change in peel m.c of commercial wax coated fruits	69
4.17	Change in peel m.c of fruits kept in ambient storage	70
4.18	Change in ascorbic acid of bee wax coated fruits	71
4.19	Change in ascorbic acid of commercial wax coated fruits	73
4.20	Change in ascorbic acid content of fruits kept in ambient storage	74
4.21	Change in firmness of uncoated fruits	76
4.22	Change in firmness of fruits kept in ambient storage	77
4.23	Depletion of O ₂ (%) in MAP of passion fruits	78
4.24	Enrichment of CO ₂ (%) in MAP of passion fruits	78
4.25	Gas composition of fruits kept in ambient storage	79

LIST OF FIGURES

Fig. No.	Title	Page No.
4.1	Schematic diagram of wax applicator	40
4.2	Change in PLW of bee wax coated fruits	42
4.3	Change in PLW of commercial wax coated fruits	44
4.4	Change in TSS of bee wax coated fruits	46
4.5	Change in TSS of commercial wax coated fruits	48
4.6	Change in TSS of coated/uncoated samples	48
4.7	Change in acidity of bee wax coated fruits	50
4.8	Change in acidity of commercial wax coated fruits	52
4.9	Change in acidity of coated/uncoated samples	52
4.10	Variation in lightness 'L' of bee wax coated fruits	54
4.11	Variation in yellowness 'b' of bee wax coated fruits	56
4.12	Variation in greenness 'a' of uncoated fruits	58
4.13	Variation in lightness 'L' of commercial wax coated fruits	59
4.14	Variation in yellowness 'b' of commercial wax coated fruit	61
4.15	Change in pulp m.c of uncoated fruits	64
4.16	Change in peel m.c of uncoated fruits	68
4.17	Change in ascorbic acid of uncoated fruits	72
4.18	Change in firmness of bee wax coated fruits	75
4.19	Change in firmness of commercial wax fruits	76

LIST OF PLATES

Fig. No.	Title	Page No.
3.6	Hunter lab colour flex meter	34
3.7	Texture analyser	35
4.1	Side view of wax applicator	39
4.2	Top view of wax applicator	41
4.3	Fruits after first week of storage	56
4.4	Fruits after second week of storage	58
4.5	Fruits after third week of storage	61
4.6	Fruits after fourth week of storage	80

LIST OF ANNEXURES

No.	Title	Page No.
I	Effect of wax coating on PLW of fruits	95
II	Variation in TSS during the storage period	96
III	Effect of wax coating on acidity of fruits during storage	97
IV	Change in colour parameters of passion fruits during storage	98
V	Variation in pulp m.c during storage	101
VI	Ascorbic acid deviation during storage	102
VII	Change in firmness during the storage of passion fruit	103

Symbols and Abbreviations

CO ₂	Carbon di-oxide
°C	°Celcius
cm	centimetre
c.w	commercial wax
CA	Controlled Atmosphere
<i>et al.,</i>	and others
etc.	et cetra
Fig.	figure
g	gram
ha	hectare
HDPE	High density poly ethylene
h	hour(s)
i.e.	that is
K.C.A.E.T	Kelappaji College of Agricultural Engineering and Technology
kCal	kilo calorie
kg	kilogram
LDPE	Low density poly ethylene
MAP	Modified atmosphere packaging
m	metre
mg	milligram
mm	millimetre

MT	Million Tonnes
mins	minutes
m.c	Moisture content
O ₂	Oxygen
ppm	parts per million
<i>P.</i>	<i>Passiflora</i>
p	probability
PHT & AP	Post Harvest Technology & Agricultural Processing
PLW	Physiological loss in weight
R ²	Co-efficient of regression
RH	Relative humidity
TA	Titration acidity
TSS	Total Soluble Solids
viz.	namely
%	per cent
/	per
@	at the rate of

DEDICATED
TO
MY LOVING PARENTS

Introduction

Chapter I

Introduction

Fruits along with vegetables play a very important role in our life. They are important source of carbohydrates, proteins, organic acids, vitamins and minerals for human nutrition. The total production of fruits and vegetables in the world is around 370 MT (Anonymous, 2011). India ranks first in the World with an annual output of 32 MT fruits (Anonymous, 2011), about 8% of the world's fruit production; also is the second largest producer of vegetables and accounts for about 15% of the World's production of vegetables.

Though, India is the largest producer, the postharvest losses are 20-30% due to lack of proper harvesting, processing and storage facilities, which is valued at ₹ 230 billion (Anonymous, 2008). It is evident that the only way to cope with the present situation is to give a massive thrust to reduction of post harvest losses in order to make available more food from the existing level of production (Pulamte, 2008).

In general, after harvest, foods (e.g. fruits, vegetables, milk, meat, and fish) are liable to accelerated physiological, chemical and microbial processes that invariably lead to deterioration and loss of wholesomeness. It is then necessary to institute some measure of processing such as reduction in moisture content, denaturation of endogenous enzymes and microorganisms, or packaging in order to curtail perishability. In the absence of such processing, massive post harvest losses can ensue.

The causes of postharvest losses are improper harvesting, inadequate packaging, handling, storage and transportation facilities (Fallik and Aharoni, 2004). Poor drying facilities and marketing opportunities further aggravate the situation.

There is a wide range of postharvest technologies that can be adopted to reduce losses throughout the process. Internationally, several postharvest technologies have been introduced to control fruit disorders, maintain optimum

quality, freshness and minimize the losses (Krochta, 1997; Hagenmaier, 2002; Bajwa and Anjum, 2007). The most common technologies used commercially are low temperature storage, film packaging and emulsion applications as wax coatings (Perez *et al.*, 2002; Thakur *et al.*, 2002).

Temperature is the most important determinant of fresh produce deterioration rate. An important supplement to temperature and relative humidity management is the use of controlled atmosphere (CA) or modified atmosphere storage (MAS) and other technologies. The low temperature storage helps to increase the shelf life and reduce weight loss in fruits.

Fruits and vegetables coated with wax look better and exhibit improved shrivelling control (McGuire *et al.*, 1995). Application of physical barrier such as wax coating regulates permeability of water vapour and other gases, retards ripening and restricts insect infestation and microbial growth. The wax emulsion application is employed to control the weight loss (Kaushal and Thakur, 1996; Alam and Paul, 2001). The wax application will be an effective method for increasing shelf life and ultimately to get more income from their production.

The application of wax can be carried out either by dipping the fruits in the wax emulsion or by spraying the wax solution as a mist over the fruits or vegetable surface. It has been realized that the normal method of application (dipping, drenching etc.) had definite limitations such as excessive consumption of wax, labour intensive. Hence, wax application will be effective by the use of wax coating machine.

The benefits of film packaging include easy to handle (consumer package); protection from injuries; reduction of water loss, shrinkage, wilting; reduction of decay by modified atmosphere (MA); reduction of physiological disorders (chilling injury); retardation of ripening and senescence processes; retardation of regrowth and sprouting (green-onion radishes) and control of insect in some commodities (Aharoni, 2004). Storage in plastic films in all kinds of combinations (different materials, perforation, inclusions, individual seal packing – shrunken and non-shrunken) are types of MA storage (Irtwange, 2006).

Plastic films and waxes increase post-harvest life because fruit respiration occurs inside the coating and consequently there is a reduction in the concentration of O₂ and an increase in CO₂, and an atmosphere with high relative humidity is formed, thus reducing water loss by transpiration (Moleyar *et al.*, 1994; McGuire *et al.*, 1995; Fonesca *et al.*, 2000). In all these methods, the shelf life is extended by reducing the respiration rate and moisture loss from the fruits.

Most of the tropical fruits have a short shelf life. Passion fruit is one such fruit, which rapidly loses moisture once detached from the vine, leading to excessive wrinkling, internal fermentation and drying out within 7-10 days under ambient conditions (Pruthi, 1963). Commercially matured fruit are ground-harvested after natural drop. Fruit that abscise from the vine begin dehydrating immediately and are frequently contaminated with soil-borne pathogens.

The total global supply of passion fruit is estimated at 8.52 lakh tonnes, with major producing countries comprising of Brazil, Mexico, Ecuador, Australia, Zimbabwe, Kenya and Columbia. In India, passion fruit cultivation is confined to Kerala, Tamil Nadu (Nilgiri hills and Kodai Kanal), Karnataka (Coorg) and north-eastern states (Mizoram, Nagaland, Manipur and Sikkim) with an area and production of 9,000 ha and 45,000 tonnes (Kundan, 2009) respectively. The average productivity comes to 5.02 T.ha⁻¹, abysmally low to 30-35 T.ha⁻¹ harvested in the countries like Brazil, Australia, Colombia etc (Joy, 2010). This is due to the high perishability of the fruit and utmost care must be taken in the post harvest handling and processing to reduce the post harvest losses.

Incompetent handling of fruits results in injury to the surface layer making them more susceptible to attack by spoilage organisms with consequent reduction in consumer appeal in the market. These conditions further aggravate to the development of physiological disorders such as, weight loss during marketing and storage, fruit rot etc. Hence, post harvest loss reduction technologies are necessary to extend the shelf life of passion fruit. The passion fruit cultivation is an important source of income for small to medium producers. Thus, the technologies must be cheap for them to adopt.

Considering the facts and situations, study was undertaken to investigate the effects of extension of post harvest shelf life of passion fruit with the following objectives:

- i. To develop a wax applicator for passion fruit.
- ii. To standardise the pre-treatment for the passion fruit.
- iii. To standardise a Modified Atmosphere Packaging (MAP) by understanding the quality parameters of passion fruit.
- iv. To evaluate the post harvest behaviour of passion fruit during storage and handling by measuring the quality parameters.

Review of Literature

Chapter II

Review of Literature

A critical comprehensive review of literature is inevitable for any scientific investigation. A brief report of research works carried on the shelf life studies of passion fruit are presented in this chapter. This chapter provides the background information on the issues to be considered in the present research work and to focus the relevance of the present study. The purpose is also to present a thorough understanding of the storage of fruits.

2.1. History

Passion fruit has a long and colourful history of popularity and extensive cultivation, starting in the late 19th century, when it was introduced to Hawaii in 1880. It quickly became a “household word” and, at the turn of the 21st century, Hawaii is the state with the highest per-capita consumption of passion fruit juice in North America. Today, passion fruit is grown nearly everywhere in the tropical belt of South America to Australia, Asia and Africa and plantations are found in California (USA) (Joy, 2010).

2.1.1. World production and trade

South America is currently the largest producer of passion fruit worldwide. Native to Brazil, it is immensely popular there. Ecuador, having comparative advantage for the growth of passion fruit, is one of the largest producers in the world with a dominant share in the world export market. It is followed by Australia and New Zealand in export of the fruit to other countries. Kenya and South Africa also have a decent production of passion fruit and its area under cultivation is growing rapidly (Beninca *et al.*, 2007).

India, too, has its place in passion fruit history. In India it is found to be growing wild in many parts of Western Ghats such as Nilgiris, Waynad, Kodaikanal, Shevroys, Coorg and Malabar as well as Himachal Pradesh and North Eastern States like Manipur, Nagaland and Mizoram.

2.1.2. Varieties

It belongs to a genus *Passiflora* (Passifloraceae) of woody perennial vines with 400 known species, 40-60 of which bear edible fruit (Montanher *et al.*, 2007; Beninca *et al.*, 2007). But of these only two are cultivated widely: the passion fruit (*P.edulis*) and the giant granadilla (*P.quadrangularis*) (Souza *et al.*, 2004).

The species *Passiflora edulis* is a vigorous liana, with stems 20, 50 or even 80 m long (Joy, 2010). The different varieties of passion fruit are:

- **Purple passion fruit** has small, globular to ovoid fruits 4 to 9 cm long and 4 to 7 cm in diameter with a moderately brittle pericarp and strongly aromatic dark yellow pulp forming 35 to 50% of fruit weight. This is suited to tropical and subtropical regions and hence most commonly cultivated in high latitudes or elevations.
- The **yellow passion fruit** *Passiflora edulis f. flavicarpa* is more vigorous than the purple variety. Its fruits are round to oval with a smooth, yellow surface and also more attractive than purple. The pericarp is harder and the fruit is larger-from 6 to 12 cm long and 4 to 7 cm in diameter and weighing 60 to 150 g. They are less aromatic and slightly more acid. Yellow passion fruit requires high temperatures (20 to 34°C) and grows better at a low elevation. The juice yield is 30-46%.
- **Sweet passion fruit** or sweet granadilla (*Passiflora liqularis*) is a vigorous liana. The fruits are round to ovoid and measure 5 to 9 cm long by 4 to 7 cm in diameter. The pericarp is thin and brittle. The pale grey pulp is aromatic and slightly acidulous. The juice yield is 30%.
- **Giant granadilla** (*P.quadrangularis*) is 20-30 cm long and to 18 cm in diameter. The fruit is yellowish green, sometimes pinkish and ovoid to oblong. It weighs an average of 2.8 kg and can reach 4 kg. The pulp is pale, white to orangey and sweet and acidulous.
- **Banana passion fruit** (*P.mollissima*) is an oblong fruit 6 to 10 cm long and 3 to 5 cm in diameter, with more or less rounded extremities. It weighs 50 to 150 g. The pericarp is pale yellow, green in rare cases, more

or less pubescent, thin and flexible but leathery. The pulp forms 60% of fruit weight and is salmon pink to dark orange. It has low acidity and is very pleasantly aromatic but usually astringent.

2.1.3. Morphological and physiological characteristics

Passion fruit exhibits a typical climacteric pattern of respiration. Akamine *et al.*, (1957) found that when stored in air at 25°C the fruit reached its climacteric peak after 13-14 days and attained a peak ethylene production of 370 $\mu\text{Lkg}^{-1}\text{hr}^{-1}$ after another 7 days. When stored under applied ethylene (500 ppm), the climacteric peak was reached within 2 days. Oxygen uptake increased with the level of ethylene applied indicating an interaction between ambient ethylene and respiration rate. However, the level of ethylene applied was far in excess of normal physiological levels.

When stored at 6.5°C, Pruthi (1963) found that the climacteric peak was delayed for up to 2-3 weeks and the respiratory activity was found to range between 101-272 $\text{mg CO}_2\text{kg}^{-1}\text{hr}^{-1}$ over the storage period of 4 weeks.

Externally the tough purple rind is smooth, glossy and is covered with a thin layer of wax. The edible portion of the fruit is 86% water (Chan, 1980) and 30-40% of the fruit weight can be recovered as juice (Purseglove, 1980).

The fruit is a round or oval berry, deep purple when ripe, dotted and glabrous. It averages 40-70 mm in diameter, 40-90 mm in length and 25-38 g in weight. The pericarp is 3-6 mm thick, moderately hard and the pulp yellow to orange in colour with a pleasant aroma, having 100-150 black edible seeds embedded in it (Knight and Sauls, 2009).

2.2. Nutritive and medicinal value

Passion fruit is rich in phosphorus, calcium, and vitamin A and particularly rich in easily digestible carbohydrate (Pruthi, 1963; Arjona and Matta, 1991). Several species are also of ornamental interest, and some are used for their sedative, antispasmodic, antibacterial and anti-insect properties.

The purple passion fruit has a very attractive flavour and is versatile in its culinary utilization (Heal and Allsop, 1986; Werkhoff, 1998) giving it a big potential to grow as a major fresh fruit line in the UK.

The pulp may be eaten directly from the shell or used in fruit salads, ice creams, sorbets, tropical punches and various other recipes (crepes, crème patisserie, etc) (ITC Newsletter, 1989). The nutritive values of passion fruit are listed in Table 2.1.

2.3. Engineering properties of fruits

Harmond *et al.*, (1965) reported that, the size refers to characteristic of an object, which determines how much space it occupies and within limits, can be described in terms of length, width and thickness. Mohsenin (1970) reported that the physical properties of any material such as shape, volume and surface area are important in many problems associated with design or development of specific machine. Pappas *et al.*, (1988)

Table 2.1 Nutritive value of passion fruit per 100 gram of the pulp (National Nutrient Database, 2012)

Nutrient	Unit	Value per 100.0g
Proximates		
Water	g	84.21
Energy	Kcal	60
Protein	g	0.67
Total lipid (fat)	g	0.18
Carbohydrate	g	14.45
Fibre	g	0.2
Sugar	g	14.25
Minerals		
Iron	mg	0.36
Magnesium	mg	17
Phosphorus	mg	25
Potassium	mg	278
Sodium	mg	6
Zinc	mg	0.06
Calcium	mg	4
Vitamins		
Vitamin C	mg	18.2
Vitamin A	IU	1000-2000
Niacin	mg	2.24

used multiple regression analysis to describe the shape of cowpeas using the three principle dimensions i.e. length, width and thickness.

Ibrahim (1992) indicated that the processed materials vary considerably in their physical properties such as size, shape, density, volume, specific gravity, and surface texture. These characteristics are very important in many problems associated with design or development of specific machine, analysis of the behaviour of the product and handling. Kaleem *et al.*, (1993) stated that, the angle of repose is very important in the determination of the inclination angle of the machine. Hatem *et al.*, (2005) found that the olive fruit length, diameter and weight were directly proportional to its pit for the investigated varieties.

2.4. Factors affecting storage life and quality of passion fruit

2.4.1. Harvest maturity

Passion fruit is climacteric, and the climacteric rise occurs while the fruit is still attached to the plant (Biale, 1975). When it ages, the epiderm wrinkles but this does not affect the quality of the pulp. It keeps well for 4 to 5 weeks at 8 to 12°C. The shelf-life depends on the stage of maturity but is generally 5 or 6 days.

A passion fruit orchard may have a life span of 3-5 years. There are two major seasons of production, June to August and November to January. Fruits are harvested when they have dropped to the ground. Green or immature fruits should not be picked off the vine as they will not ripen; they will also be off flavoured and have a higher concentration of cyanogenic glycosides (a toxin produced by the vine). Fruits should be collected 2 to 3 times per week.

Pruthi (1963) found that out of fruit picked at 4 different stages, *viz.*,

- Pale greenish-yellow;
- Partially purple;
- Just ripe purple and
- Deep purple, plant-ripened, slightly shrivelled, fruits allowed to fall from the plant.

Fruits allowed to fall from the plant are stored at 6.5°C, 85-90% RH, maximum weight loss occurred at the first and fourth stages was found to possess good physicochemical properties, but the deep purple fruit had juice with better aroma.

Akamine *et al.*, (1957), Hall (1958) and Chan *et al.*, (1988) stated that green-ripe fruit, even if allowed to ripen off the vine, possess a woody off-flavour. However, for the fresh market Pruthi (1963) and Chan *et al.*, (1988) recommend that fruit must be picked off the vine, rather than allowing them to drop off naturally to avoid excessive shrivelling.

Hall (1958) on the other hand stated that passion fruit, once detached from the vine, would never ripen and recommended that fruit for the fresh market must not have any green showing on the skin at harvest.

Because ripe passion fruit loses moisture rapidly once detached from the vine, marketing must be done immediately if losses of up to 10-20% in weight are to be avoided (Akamine *et al.*, 1957).

2.4.2. Method of harvest

Fruit can be picked with the stalk intact, pulled from its stalk, or allowed to drop to the ground after ripening naturally. Pruthi (1963) reported minimum physiological weight loss and less attack from moulds during storage when fruit was picked with stalks clipped down to about 0.7 cm.

2.4.3. Storage of fruits

The basic concept of storage is to extend the shelf life of products by storing them in appropriate conditions to maintain their availability to consumers and processing industries in their usable form. They can either be stored naturally in the field, or in built storages (Pantastico *et al.*, 1975; Raghavan and Garipey, 1985). In natural storage the product is left in the field and harvesting is delayed, while in artificial storage favourable conditions are provided which help to maintain product freshness and nutritional quality for a longer period. During storage, the passion fruit physiology and its ripening involves many

physiochemical activities, such as cumulative physiological loss in weight (CPLW), acidity, loss in firmness, increase in total solids.

The total yield of fresh passion fruit can be increased by improving the storage conditions. There are various techniques, which have been developed to improve the storage life and maintain the quality of fresh horticultural commodities.

2.4.3.1. Controlled and modified atmosphere storage

In recent years much focus has been laid down on internal gas composition of storage. MAP of fresh fruits and vegetables refers to the technique of sealing actively respiring produce in polymeric film packages to modify the O₂ and CO₂ levels within the package atmosphere (Jobling, 2001). In addition to atmosphere modification, MAP vastly improves moisture retention, which can have a greater influence on preserving quality than O₂ and CO₂ levels. Furthermore, packaging isolates the product from the external environment and helps to ensure conditions that, if not sterile, at least reduce exposure to pathogens and contaminants (Mir and Beaudry, 2000).

MA storage technique can also be used to maintain the postharvest quality of different fruits (Meir *et al.*, 1998 ; Ding *et al.*, 2002 ; Rodov *et al.*, 2002 ; Illeperuma and Jayasuriya, 2002). MA storage has been found to be effective in controlling the rate of metabolic activities (Singh *et al.*, 1998).

The storage life of unripe fruit was increased from 3 to 6 weeks (Huelin, 1962) by storage in an atmosphere containing 5% CO₂ and 5% O₂. Response to hot wax treatment and CAS reduced with maturity of fruits (Huelin, 1962).

Studies on MAP of horticultural commodities show that highly permeable films such as polyvinyl chloride (PVC) overwraps can maintain postharvest quality by reducing transpiration and respiration (Kader, 1986).

The basic idea of Controlled Atmosphere Storage (CAS) is to maintain the best product quality. This can be accomplished by keeping CO₂, O₂ and ethylene gases at predetermined levels (gas levels differ depending on the type of fruit

being stored). Usually decreased O₂ and increased CO₂ levels at a low temperature with high RH are suitable for stored commodities. CA can provide an effective storage environment for different fruits and vegetables (Bender *et al.*, 2000; Raghavan *et al.*, 2003).

2.4.3.2. Storage at low temperature

While storing fruits the first priority is to maintain the quality of the product. Low temperature storage is one of the most commonly adopted methods to maintain the fruit quality. For successful storage it is necessary to efficiently control the temperature throughout the storage period. The principle behind cold storage is to delay the period of ripening of a product by slowing down its physiological activities.

Passion fruit is a tropical climacteric fruit (Biale, 1975; Wills, *et al.*, 1982) subject to chilling injury when stored below 6.5°C (Pruthi, 1963). Recommended storage temperatures are 5-7°C (Pruthi, 1963), 3-5°C (Wills *et al.*, 1982) and 7-10°C (McGregor, 1987).

At tropical ambient temperatures (24-33°C), passion fruit rapidly loses moisture, shrivels and the pulp ferments, leading to off-flavours within 7-10 days. Fungal attack will be manifest at any temperatures above 7°C (Pruthi, 1963).

At 6.7-7°C the fruit can be stored for 4-5 weeks (Pruthi, 1963), although much of the flavour is lost during this storage period (Kefford, 1954; Chan *et al.*, 1988). Hall (1958) reported that fruit could be kept in the warmer part of a refrigerator for up to 2 weeks after which they will chill, the skin will become soft and papery and rots will develop. Pantastico *et al.*, (1975) also recommended storage temperatures of 5.6-7.2°C and 85-90% RH, but stated that under such conditions fruit could be stored for 3 weeks only. Low temperature injury takes the form of a blood-red discolouration of the skin followed by mould attack (C.S.I.R.O, 1934).

Cantwell (2001) recommended the storage temperature for passion fruit as 10°C with 85-90% RH. The fruits stored under this condition have a shelf-life of 3-4 weeks.

Passion fruit stored at 5°C and 85% RH lost moisture rapidly: 80% of the fruit surface was shrivelled after 3 days of storage (Arjona *et al.*, 1992). While passion fruit juice remained wholesome for 7 days, fruit began shrivelling soon after abscission (Knight and Sauls, 2009). The rind accounted for most of the dehydration in the first 15 days of storage (Arjona, 1990).

2.4.3.3. Plastic packaging

Plastic packaging is also one of the factors that increase the post-harvest life by reducing the transpiration and respiration rates of the fruits (Silva *et al.*, 1999; Fonesca *et al.*, 2000).

Pruthi and Lal (1955) found that packaging fruit in plastic films reduced weight losses to within 0.1% in four weeks of storage at 6.5°C, but found that mould attack was more than in control fruit due to high relative humidity. Fruits packed in plastic bags treated with a fungicide had less mould attack. Better results were obtained when plastic bags had side windows to permit gaseous exchange. They did not state whether the flavour was affected by storage in plastic bags.

Cereda *et al.*, (1976) reported that passion fruit stored in polyethylene bags at 7.2°C and 85% to 90% RH remained marketable up to 30 days. Storing passion fruit in sealed polyethylene bags at 6°C to 10°C can protect them from shrivelling for 3 to 4 weeks (Campbell and Knight, 1983). However, moisture condenses on the fruit surface under consistently high RH, creating conditions favourable for pathogen growth (Zagory and Kader, 1988). For fresh fruit use, water loss that results in wilting and shrivelling must be minimized.

Mota *et al.*, (2003) evaluated the influence of a MA – wax emulsions and plastic film – on the shelf life of the yellow passion fruit. Plastic film (Cryovac D-955, 15µm thickness) reduced fresh weight loss and fruit wilting, kept higher

fruit and rind weight and higher pulp osmotic potential over the storage period. Also, he found that among the tested waxes, fruit wax (18-21% carnauba wax) was the best, promoting reduced weight loss, wilting and rottenness.

Akath *et al.*, (2007) studied the shelf life and quality of passion fruit with polyethylene packaging under specific temperature. The fully ripened fruits were packed in perforated and non-perforated HDPE (0.03, 0.05, 0.08mm) and LDPE (0.025mm) and stored at ambient temperature. Fruits packed in perforated HDPE of 0.03 mm thickness showed a shelf-life of 28 days at 5°C as against 4 days for control. Quality and nutritional value of fruit were better preserved, but there was slight reduction in flavour and colour of juice. The quality parameters, TSS, TA, sugars and ascorbic acid contents were at par with initial value even after 28 days of storage.

Randhawa *et al.*, (2009) showed the effect of HDPE packaging with edible oil and wax coating on storage quality of 'Kinnow' mandarin. The shelf-life of 'Kinnow' mandarin was enhanced by the use of HDPE packaging, followed by edible oils (neem, mustard, coconut and olive oils) and wax (Citrashine) coating. Results revealed that highest palatability rating after 45 days of ambient storage was recorded in the fruits which were only HDPE packed. The fruits treated with neem oil+HDPE packaging recorded highest juice content and minimum spoilage during storage. Maximum TSS content and physiological losses in weight were found in control fruits.

Hailu *et al.*, (2011) studied the effect of packaging material on the quality of banana fruits. They found that fruits packed in flexible bags remind marketable for over 4 weeks where as unpackaged fruits remind marketable only for 15 days. Also, the chemical qualities were maintained in packed fruits.

Santana *et al.*, (2011) evaluated the effect of MAP and cold storage on quality and storage life of the peaches. In their study, the fruits were packed in PP trays and placed inside LDPE bags (30, 50, 60, 75µm thickness) with active MA (10 kPa CO₂ + 1.5 kPa O₂, balance N₂). The control was made with peaches held in unwrapped PP trays. Fruits were kept at 1±1°C and 90±5% RH for 28 days and

CO₂ and O₂ within packages was monitored every two days. The fruits wrapped in bags maintained its quality.

2.4.3.4. Storage by use of coating

Films and coatings have received much attention in recent years because they extend shelf-life and improve food quality by providing a barrier to mass transfer, carry food ingredients and improve mechanical integrity or handling characteristics of a food (Krochta, 1997). Waxing is one of the coating technologies suitable for preservation of fruits and vegetables. By this method we can increase the shelf-life of agro-produce by more than 2 weeks. This gives breathing time for marketing. This will also increase the market (Anonymous, 2004). Some of the benefits of waxing include improved appearance, less moisture loss, less economic loss, reduced postharvest decay, longer postharvest life and less susceptibility to chilling injury.

Trout *et al.*, (1953) defines surface coating as a very thin film of wax, oil, emulsion, or other suitable material applied to the surface of a fruit as an addition to or a replacement of the natural protective waxy layer on the fruit.

Mollenhauer (1954) reported that fruit dipped in hot paraffin wax was in good condition after 2-3 months of storage, although the flavour had deteriorated. Dipping in hot paraffin wax apparently sterilised the skin preventing mould attacks and prevented shrivelling. He also suggested that it caused quick evaporation of volatiles from the fruit through the layer of wax, leading to poor flavour. Pruthi and Lal (1955) recommended that waxed fruit should be stored for only 4-5 weeks at 6.5°C. Huelin (1962) reported that dipping fruits in molten wax extended storage life from 3 to 6 weeks.

Nyambati (1984) reported that passion fruit treated with 2% and 2.5% Pro-long had lower respiration rate, better flavour, less wrinkled and lost less weight than untreated fruit after 28 days at 24°C and 85% relative humidity. At 8°C he did not find any significant effect of Pro-long on these parameters. Pro-long is an

edible mixture of lipids and a polysaccharide, which is semi-permeable to carbon dioxide and oxygen (Kader *et al.*, 1986).

According to Petracek *et al.*, (1998) internal O₂ concentrations in fruit should always be higher than 12%. He reported that the use of carnauba or polyethylene waxes often results in less shine, but allows greater O₂ and CO₂ gas exchange than shellac wax. Candelilla wax has low shine, low melting point and low water vapour permeability. This wax is usually mixed with other waxes to maximize its coating effect on fruit quality (Dou *et al.*, 1999). Recently the use of various types of oil applications to coat oranges is gaining popularity.

Ladaniya (2001) found that wax coating reduced respiration rate of 'Mosambi' fruits. The change of colour from green to yellow was quite slow in wax coated fruit as compared to non-coated fruit. After 30 days of storage, yellow colour intensity was more in degreened + non-waxed fruit as compared with non-degreened + non-waxed fruit. He also found that fruits packed without polyethylene liner lost more juice and ascorbic acid and had more firmness, TSS and acidity content.

Nanda *et al.*, (2001) studied the effects of individual shrink film wrapping with two polyolefin films (BDF-2001 and D-955) and skin coating with a sucrose polyester (SPE) Semperfresh™ on the shelf life and quality of soft-seeded 'Ganesh' pomegranates (*Punica granatum* L.) stored at 8,15 and 25°C. The shrink-wrapped pomegranates could be stored for 12,9 and 4 weeks as compared to 8,6 and 2 weeks by SPE coating at 8,15 and 25°C respectively, whereas non-wrapped fruits could be kept for 7,5 and 1 week under similar storage conditions. Peel thickness and freshness and firmness of the fruit were retained and weight loss greatly reduced by shrink wrapping. The weight loss in shrink-wrapped fruits was 1.2-1.3% after 12 weeks of storage at 8°C and 2.2-3.7% after 10 weeks at 15°C. During the same period non-wrapped fruits lost 20.4 and 30.7% at 8 and 15°C, respectively. Changes in acidity, sugars and vitamin C of the shrink-wrapped fruits were lower than that of non-wrapped fruits during 12 weeks of

storage at 8°C. Shrink wrapping also reduced the respiration rate of the fruit. No detectable levels of ethylene were produced during storage of pomegranates.

In passion fruit, the outer surface is shiny. This shining comes because of natural waxes. When this wax evaporates, the fruit become dry. Wax prevents evaporation of water in the produce. So by increasing the layer of wax, shelf life can be increased. When we see a fruit under microscope we can see small holes like those on our skin. By applying wax these holes are blocked so water in the produce cannot come out. So the shelf life is increased (Thirupathi *et al.*, 2006).

Silva *et al.*, (2009) evaluated the shelf life of the yellow passion fruit coated with different substances (carnauba's wax, rubber tree latex, solution of calcium chloride and cassava starch) stored under temperature atmosphere. He found that the weight of the fruit, titrable acidity (TA), soluble solids (SS), ratio SS/TA and ascorbic acid of the fruit was not affected by the coating with fruit wax, rubber tree latex, calcium chloride and cassava starch. Also, the rubber tree latex was found to be the most effective coating as the mass loss was very much reduced.

2.5. Wax application methods

Waxes may be applied in several different ways, ranging from manual rubbing of the product surface to automated roller brush application (Anonymous, 2004).

2.5.1. Manual rubbing

Liquid waxes can be applied manually by rubbing the commodity and smearing the wax evenly over the surface using a soft absorbent cloth or fine bristled brush. After which, the products should be left to air dry for about 15 minutes before packing (Anonymous, 2004).

Table 2.2 Classification of waxes

Animal waxes	
❖ Bee wax	❖ Spermacefi wax
❖ Shellac wax	❖ Chinese insect wax
Vegetable wax	
❖ Carnauba wax	❖ Candelilla wax
❖ Sugarcane wax	❖ Palm wax
❖ Esparto wax	❖ Japan wax
❖ Oricury wax	❖ Waxol 0.12
Mineral and Synthetic waxes	
❖ Ozocerite	❖ Montan wax
❖ Synthetic wax	❖ Semperfresh

2.5.2. Dipping / Submergence

In dipping, the wax is applied as a brief dip or submergence of the product in a bath of melted wax for about one second or less. It is very important the product surface be completely dry before dipping. If not dry, the high temperature of the melted wax converts the surface moisture on the product into steam and forms pockets or blisters under the wax coating. The wax will then loosen and drop off (Anonymous, 2004).

2.5.3. Roller Brushing

Liquid waxes can also be applied automatically to the surface of the commodity by pump through low pressure nozzles. Irrigation drippers can also be used to apply the wax. (Anonymous, 2004).

Fitzgerald (1958) developed a wax coating machine for fruits and vegetables. In his applicator, the melted wax is deposited on an applicator brush or buffer in order to apply wax uniformly over the surface of the fruit.

Gillespie (1980) developed a wax applicator for citrus fruits. In this applicator, the wax is dispensed through two travelling nozzles over the fruit passing through roller brushes.

Rajkumar *et al.*, (2007) fabricated a hand operated wax applicator. It consists of a feed hopper, cylindrical drum known as wax vat, impeller fitted with four paddles mounted on a shaft and outlet chute. A handle is provided at one end of the shaft to rotate the impeller. The vanes are made up of perforated sheets with oblong perforations. The vanes are positioned at an angle of 45° to the tangent. The impeller is housed inside a casing which is split into two halves. The bottom half of the casing is used to hold the wax, also known as wax vat. The successive vanes of the impeller along with the casing form four packets. These packets receive the fruits from the feed hopper, conveying them through the wax emulsion contained in the wax vat and also deliver the fruits due to gravity through the outlet chute; the entire unit is supported on an L angle frame of convenient height.

2.6. Physicochemical changes during the storage of fruits

There is an inverse relationship between the fruit growth rate, its quality and extended storage on the tree and postharvest life. It has been observed that the juice content decreases with delayed harvest and so the fruit keeping quality.

2.6.1. Physiological Loss in Weight (PLW)

Physiological loss in weight (PLW) commonly designated as weight loss is transpiration of water from the rind epidermal cells, resulting in concentration of existing carbohydrates, particularly total sugars and reduction in fruit weight. The loss in weight can range from 1.5 to 34% depending upon storage conditions and fruit coatings (Kaushal and Thakur, 1996).

A minimum weight loss (1.5%) in fruits is the result of coatings that are applied on the fruit surface to protect postharvest loss in weight, while uncoated fruit may lose its 33.23% weight (Alam and Paul, 2001; Thakur *et al.*, 2002). Sharp increase in PLW of fruit occurs at room temperature, while it is

significantly lesser when fruit is waxed and stored in cold chamber (Shellhammer and Krochta, 1997).

An increasing trend in the PLW of fruit during storage is a major factor contributing to deterioration in the fruit quality. The loss in weight in passion fruit has resulted in the incorporation of different applications in the form of waxing, polyethylene packaging and low temperature storage. PLW can be significantly controlled when fruits are packed in polyethylene bags and kept under cool conditions (Kaushal and Thakur, 1996). Film wrapping has a positive impact on the water loss from the fruit surface.

Arjona *et al.*, (1994) placed vine-ripened yellow passion fruit in Styrofoam trays and wrapped with VF-60 plastic film and stored for 15 and 30 days. He found that wrapping prevented fruit weight loss while maintaining external appearance.

Studies on different mandarin varieties have shown positive effects of film wrapping on the quality of mandarins (Aquino and Palma, 2003). Film wrapped fruit completely inhibits transpiration thereby reducing the loss in weight at the end of storage. Changes in the fruit composition are dependent on internal atmosphere of the fruit, which usually alters once harvesting has been done and is dependent on storage conditions. Most commonly employed technique is low temperature storage which slows down respiration rate and minimizes the rate of metabolic processes.

Matuska *et al.*, (2006) found strawberries when coated with edible coating had reduced weight loss than non-coated fruits. There was roughly a 30% difference in rates of water loss between the different treatments.

2.6.2. Firmness

Firmness is defined, as specific force required to deform a fruit. Firmness is frequently used as a quality index for fruits and vegetables and is related to the product's maturity, freshness and extent of bruising or compressive damage (Hahn, 2004). Loss of firmness can be an indicator of the end of shelf-life and a

key factor that influences the consumer's acceptance of the product (De Ketelaere *et al.*, 2006). The fruit, which is more firm, shows less deformation from a given applied force.

Hagenmaier (2000) and Rojas *et al.*, (2002) reported that firmness and strength of citrus improved when fruit was coated, while uncoated fruits turn soft with the passage of storage time. In initial storage periods there is not much difference in the firmness of coated and uncoated fruit, but under prolonged storage conditions coated fruits stay firm as compared to uncoated ones (Perez *et al.*, 2003).

Besides loss in firmness, fruits after harvesting undergo different chemical and biological phenomenon such as decay, deformation of original structure, weight and changes in firmness and reduction in overall appearance (Aquino and Palma, 2003).

2.6.3. Ascorbic acid

Ascorbic acid is a water-soluble vitamin that is commonly found in relatively high concentrations in many fruits (Kays and Paull, 2004). It rapidly oxidizes by the action of light and heat and by the action of ascorbic acid oxidase. Prolonged storage of fruits results in losses in vitamin C. Changes under cold conditions are less as compared to room temperature (Pal *et al.*, 1997). Fruits treated with coatings contain significantly higher ascorbic acid as compared to uncoated fruits. Similarly, fruit stored at lower temperatures (7°C, 10°C and 12°C) has significantly higher ascorbic acid as compared to fruits stored under ambient conditions (Thakur *et al.*, 2002). The decline in ascorbic acid content depends upon the harvesting period.

2.6.4. Titrable acidity

Acids are one of the energy reserves of the fruit; therefore these are used in the respiration process and converted to more simple molecules such as CO₂ and water (Wills *et al.*, 1998). As a result of respiration, acids decrease, but water loss in the fruit increases its concentration.

El-Anany *et al.*, (2009) evaluated the effect of edible coating on the shelf-life and quality of Anna apple during cold storage (0°C, 90-95% RH). The results indicated that coated apples showed a significant delay in the change of weight loss, firmness, titrable acidity, TSS, decay and colour compared to uncoated ones. Sensory evaluations results showed that coatings maintained the visual quality of the Anna apple during the storage time.

Marupadi *et al.*, (2011) studied the enhancement of storage life and quality maintenance of papaya fruits using Aloe Vera based antimicrobial coating. The results showed that the titrable acidity in the fruit samples decreased with storage time in both control and treated fruits. However, the difference was to a lesser extent in coated fruit compared to control.

2.6.5. Moisture content of pulp and peel

According to Ssemwanga (1990), passion fruit loses moisture mainly from its skin and loss is more rapid during the first 1-2 weeks after harvest. Also, he found that moisture loses as the fruit shrivels. Hence, he concluded that fruits coated with semperfresh didn't lose moisture.

Banks *et al.*, (1997) stated that surface coatings can reduce moisture loss and retard ripening of avocados without adversely affecting the other aspects of fruit quality. The avocados can lose 1% of its moisture each day at 20°C, 60% RH. Surface coatings like wax act as a good barriers to water vapour. This reduces the rate at which water evaporates from the fruit surface and thereby slows loss of saleable weight. Thus, he found that waxing reduced moisture loss by up to 50%.

2.6.6. Total Soluble Solids

Hayat *et al.*, (2003) investigated the effect of different concentrations of CaCl₂ (1%, 1.5%, 2%), paraffin wax coating and different wrapping materials (polyethylene, carton paper) in order to increase the shelf life and to avoid the postharvest losses of apple. In this study, the minimum weight loss was observed in the samples treated with CaCl₂. The possible reason may be that CaCl₂ served

as a semi permeable membrane around fruit surface which resulted in reduction of evapo-transpiration and rate of respiration. The chemical characteristics, TSS, pH, acidity, total sugar, reducing sugar and vitamin C were analyzed after 15, 30, 45 and 60 days of storage. All the treatments had significant effect on the shelf life of fruits.

2.6.7. Colour analysis

Colour of fruits plays an important role in fruit consumption and is one of the most important quality attributes in the selection process. Sometime colour influences flavour recognition and it affects consumer perception.

Akamine *et al.*, (1956) reported a delay in the colour development of quarter-to-half purple fruits stored at 25°C compared to those at 20°C. Ethylene treated fruits at both temperatures coloured more rapidly and evenly than fruits stored in air. Further, he found that even the half-coloured fruits were internally fully ripe at the end of the experiment, suggesting that colour was not a reliable maturity index. However, Pruthi (1963) found colour to be a fair index of maturity.

2.6.8. Appearance

Impairment of fruit appearance due to loss in weight starts after the second week of storage, turning the fruit unattractive owing to formation of wrinkles on the skin (Raghav and Gupta, 2000) as well as leathery and unacceptable condition of the peel (Aquino *et al.*, 2001).

Matta *et al.*, (2006) studied the shelf-life of yellow passion fruit which were placed in polystyrene tray and overwrapped with a plasticized PVC film. In his experiment he stored the wrapped and non-wrapped fruit at 10°C for 15 or 30 days at 85% RH in a commercial ripening banana chamber. The fruits were analyzed after 15 and 30 days of storage. Film-wrapped fruit had a better appearance, than non-wrapped fruit. Also, non-wrapped fruit had the highest weight loss, and weight loss increased with storage time. In these experiments, wrapping fruit with plasticized film minimized fruit weight loss and maintained

the external appearance of stored fruit. RH under the wrapped treatments was not measured, but condensation, which may have contributed to the mold growth, formed in the packages after 25 days of storage.

Kundan *et al.*, (2011) stated that the maximum weight loss in purple passion fruit was recorded under room temperature ($25 \pm 1^\circ\text{C}$) than under cold storage ($8 \pm 1^\circ\text{C}$). He reported that the physico-chemical and the appearance of the fruit remained as such for only 5 days at 25°C and it was upto 21 days at 8°C .

Materials & Methods

Chapter III

Materials and Methods

This chapter deals with the details of the materials and the methodology followed during the course of the present investigations.

3.1. Experimental Materials

3.1.1. Fruit sources

Yellow variety of passion fruits were harvested from the commercial orange and vegetable farm of Nelliampathy, located at geographic coordinates; 10°18'52''N and 76°24'43''E and 610 m altitude. Fruits with 70-80% of green rind colour were selected for the study. After harvesting, the fruits were placed inside cartons and transported at 18 - 20°C to the postharvest technology laboratory of K.C.A.E.T within 4 h after harvest. The fruits were further sorted washed and air dried before subjected to treatments.

At the beginning of the experiments, an attempt was made to sort the fruit based only on size and degree of shrivelling by visual assessment. The fruits found to be excessively shrivelled, too large or small, or with obvious infection or deformities and damages, were discarded.

3.1.2. Bee wax, description and preparation

Bee wax, a natural wax of animal origin was used. It has a melting point 62 to 64°C. It was never subjected to a temperature more than 64°C, so as to avoid a chance of discolouration at an extreme of 85°C.

Bee wax maintains the quality and freshness of the fruit. Also, it prevents evaporation of water, inhibits respiration rate and polishes the skin to increase the attractiveness of fruit for consumers.

The bee wax cannot be used as such. A vegetable oil was required as a base to prepare the wax emulsion. Hence, a formulation of bee wax with rice bran oil was made. Various concentrations of bee wax in rice bran oil were tested to obtain a solution which remained at room temperature without solidification. Of

the trails conducted, the best result was obtained when the wax to oil ratio was taken as 1:100 (Alfiya *et al.*, 2010). This standardized wax was applied over the passion fruits.

3.1.3. Commercial wax, description and preparation

Commercial wax used in the present investigation was Semperfresh collected from M/s. AgriCoat Industries, UK. This was a powder formulation of sucrose esters, sodium carboxy methyl cellulose and a mixture of mono- and di-glycerides of fatty acids, all of which are derived from plant sources.

This edible formulation is designed to create a MA inside the fruit, reducing its physiological activity through restricted gaseous exchange between the interior of the crop and the environment. Commercial wax coatings create an invisible, edible protective film around the fruit. They are effective in delaying ripening and reducing spoilage of a wide range of fresh produce. In addition, commercial wax fruit coatings function by modifying the rate of respiration of the produce. Also, commercial wax treatment can help to maintain the freshness and firmness of fruits by minimising weight loss (dehydration).

The experiment is carried out using 2% solution (1% active commercial wax) i.e. 20 g/litre of water. This was prepared as follows:

Liquid commercial wax concentrate is poured slowly into the water flow while filling the container with water to the correct volume. In order to minimise foaming during this procedure the water inlet should be kept below the water level. The resulting dispersion should be left for 30 minutes with occasional stirring to use.

3.1.4. Plastic bags

Low density polyethylene (LDPE) bags of 200 gauge (50 μm) and 400 gauge (100 μm) thickness were used.

Different sets of perforations *viz.*, 0.5%, 1% and 2% were used for packing the fruits. Also, a set of fruits were kept in the bags that weren't perforated (Akath *et al.*, 2007; Santana *et al.*, 2011). As they were impermeable to moisture

migration and low temperature, the problem of moisture loss from fruits were solved to some extent by them.

3.2. Properties of passion fruit

The engineering properties are important in designing a machine. A sample of 20 fruits were selected at random for determining the physical characteristics, 10 of it were the bigger-sized fruits while another 10 were the small-sized fruits. The length, width and thickness were measured using a standard vernier calliper with an accuracy of 0.01mm. The fruit shape was expressed in terms of its sphericity and aspect ratio.

Sphericity is a yardstick to measure the roundness or spherical nature of an object. This parameter was responsible for movement of fruits from the feed hopper to the wax coating unit. For the sphericity (S), the dimensions obtained in size above were used to compute the index based on the recommendation as follows (Sahay and Singh, 1994):

$$S = \frac{(abc)^{1/3}}{a} \quad \text{--- --- 3.1}$$

where a is length (cm), b is width (cm) and c is thickness (cm). The aspect ratio (R_c) was calculated as recommended (Owolarafe and Shotonde, 2004):

$$R_c = \frac{b}{a} \times 100 \quad \text{--- --- 3.2}$$

The surface area (S) of fruits were obtained by the formula (Mohsenin, 1970),

$$S = \pi D^2 \quad \text{--- --- 3.3}$$

The angle of repose of fruits was found using the tilting top drafting table. The table top is tilted till the fruit starts moving over the inclined surface. The angle of inclination is measured which is the angle of repose of the fruits (Sahay and Singh, 1994).

3.2. Development of a wax applicator

Based on the physical properties of passion fruit, a wax applicator was designed with a principal objective to apply a uniform and complete impervious

coating to each fruit in a continuously moving stream of fruits. The designed wax coating machine has the following components:

1. Feed hopper.
2. Tank.
3. Power source.
4. Rollers and brushes.
5. Collecting tray.
6. Wax supply system.
7. Main frame.

3.2.1. Feed hopper

A hopper made of 16 gauge MS sheet was designed.

3.2.2. Tank

A circular stainless steel vessel was taken as a tank for storing the wax necessary for the coating on fruits. The tank was considered to keep in bottom in order to collect the excess wax.

3.2.3 Power source

A single-phase electric motor (12 V) was used to drive the main shaft. Power is transmitted from the motor to the flywheel by means of a chain. The flywheel which was attached to the main shaft of the rollers and brushes moves the fruits forwardly.

3.2.4. Rollers and brushes

The rollers are necessary for conveying the fruits from the hopper to the collecting tray. In addition, it also helps in the uniform application of wax. The rollers were made of MS mesh sheet. The sheets are then welded cylindrically. From these six cylinders, 4 were covered with bristles made of nylon.

3.2.5. Collecting tray

A rectangular collecting tray made of MS steel is kept next to the brushes, in order to collect the coated fruits.

3.2.6. Wax supply system

A pump (2800 rpm) is welded on the bottom of the frame. The inlet of the pump is connected to the tank containing wax and the outlet is connected to the sprayer having numerous nozzles.

3.2.7. Main frame

A MS hollow square was used for making the frame of the wax applicator.

3.3. Working

The fruits to be waxed were fed from a hopper. The wax stored in the bottom tank was pumped and sprayed from above through a pipe having numerous holes. The brushes were saturated with wax and spin the product, smearing the wax evenly over the product surface. The fruits are collected in the collecting tray and then dried using a blower. The dried fruits are then subjected to the different treatments.

3.4. Evaluation of wax applicator

3.4.1. Capacity

Five sets of fruits (each having 10 kg) are fed into the hopper and its respective time for coating is noted using a stop watch. The average time taken for coating all the five passes of fruits is calculated. From the average time, the quantity of fruits required for coating in 1hr is calculated. Thus, the capacity of the applicator is determined.

3.4.2. Mechanical damage

One by-product of mechanization in handling of fruits and vegetables is mechanical damage. The damage is mainly due to the impact, compression and abrasion. This may result in mechanical injuries such as cuts, punctures, bruises or abrasions. The wax coated fruits were visually examined for any damage in its surface.

3.4.3. Coating efficiency

The coating efficiency of the applicator was determined manually on a 5 point scale (full cover (100%) - 5, 90-100% - 4, 80-90% - 3, 70-80% - 2, 60-70% - 1) by observing the percentage of wax cover on fruit surface.

3.5. MAP of passion fruit and its quality evaluation

The experiment was Completely Randomised Design (CRD) with 21 treatments and each having 3 replications.

3.5.1. Preparation of samples

Different samples prepared were:

1. **Bee wax (T0):** In this sample the passion fruits were coated with the bee wax emulsion alone.
2. **Bee wax + LDPE 400 gauge + 2% perforation (T1):** This sample was prepared by coating the fruits with bee wax and packed in LDPE bags of 400 gauge with 2% perforations.
3. **Bee wax + LDPE 400 gauge + 1% perforation (T2):** In this sample the fruits are coated with bee wax and packed in LDPE bags of 400 gauge with 1% perforation.
4. **Bee wax + LDPE 200 gauge + 2% perforation (T3):** In this treatment, the fruits are coated with bee wax and packed in LDPE bags of 200 gauge with 2% perforation.
5. **Bee wax + LDPE 200 gauge + 1% perforation (T4):** The fruits coated with bee wax are packed in LDPE bags of 200 gauge with 1% perforation.
6. **Bee wax + LDPE 200 gauge + 0.5% perforation (T5):** In this treatment, bee wax coated fruits are packed in LDPE bags of 200 gauge with 0.5% perforation.
7. **Bee wax + LDPE 200 gauge + without perforation (T6):** In this one, fruits coated with bee wax are packed in LDPE bags of 200 gauge without any perforation.

Similarly, a study was conducted in the fruits without using any coatings and the samples are as follows:

1. **LDPE 400 gauge + 2% perforation (T7):** In this sample, the fruits are placed in LDPE 400 gauge bags having 2% perforation.
2. **LDPE 400 gauge + 1% perforation (T8):** The fruits are placed in LDPE 400 gauge bags having 1% perforation.
3. **LDPE 200 gauge + 2% perforation (T9):** In this treatment, the fruits are packed in LDPE 200 gauge bags with 2% perforation.
4. **LDPE 200 gauge + 1% perforation (T10):** In this sample, the fruits are packed in LDPE 200 gauge bags with 1% perforation.
5. **LDPE 200 gauge + 0.5% perforation (T11):** In this sample, the fruits are placed in LDPE 200 gauge bags having 0.5% perforation.
6. **LDPE 200 gauge + without perforation (T12):** In this one, the fruits are packed in LDPE 200 gauge bags having no perforation.

Apart from these, a similar study was conducted in the fruits using Commercial wax and the samples are as follows:

1. **Commercial wax alone (T13):** In this sample, the fruits are coated with commercial wax coating alone.
2. **Commercial wax + LDPE 400 gauge + 2% perforation (T14):** In this sample, the fruits coated with commercial wax are packed in LDPE bags of 400 gauge with 2% perforation.
3. **Commercial wax + LDPE 400 gauge + 1% perforation (T15):** The fruits coated with commercial wax are packed in LDPE bags of 400 gauge with 1% perforation.
4. **Commercial wax + LDPE 200 gauge + 2% perforation (T16):** In this treatment, the coated fruits are packed in LDPE bags of 200 gauge with 2% perforation.
5. **Commercial wax + LDPE 200 gauge + 1% perforation (T17):** In this sample, the coated fruits are packed in LDPE bags of 200 gauge with 1% perforation.

6. **Commercial wax + LDPE 200 gauge + 0.5% perforation (T18):** In this one, the fruits coated with commercial wax are packed in LDPE bags of 200 gauge with 0.5% perforation.
7. **Commercial wax + LDPE 200 gauge + without perforation (T19):** In this one, the fruits coated with commercial wax are packed in LDPE bags of 200 gauge without any perforation.
8. **Control (T20):** A sample was kept as such without any treatments, as controlled sample. This was to compare the performance of other samples with respect to this sample.

3.5.2. Storage conditions

The samples were held in ambient temperature (35°C) and in a cold storage room whose temperature was maintained at 7°C with an automatic refrigeration unit (Pruthi, 1963).

3.5.3. Quality parameters evaluation

3.5.3.1. Physiological loss in weight (PLW) (%)

The physiological loss in weight in passion fruit was calculated according to the method of Thakur *et al.* (2002). For determining the PLW, fruits were weighed after imposing the treatment which served as the initial fruit weight. The loss in weight was recorded at 7 days interval until 30 days which served as the final weight. The PLW was determined by the following formula and expressed as percentage.

$$PLW (\%) = \frac{A-B}{A} \times 100 \quad \text{--- 3.4}$$

where A – Original fruit weight (g).

B – Final fruit weight in the day of observation (g).

3.5.3.2. Total Soluble Solids (° Brix) (TSS)

The TSS in passion fruit was determined from each treatment. The fruits were cut and the pulp was taken. The juice was extracted from the pulp. TSS was

determined in filtered juice by using Erma hand refractometer (0-32) according to the method described in AOAC (2000). The results were expressed as ° Brix.

3.5.3.3. Titrable acidity (%Acid)

The acidity in passion Fruit was determined as citric acid by titrating against 0.1N NaOH by following the method given in AOAC (2000). The percent acidity was calculated according to the expression given below:

$$\text{Acidity, \%} = \frac{0.1 \times \text{equivalent weight of acid} \times 0.1N \text{ NaOH} \times \text{Titre value}}{\text{Weight of sample}} \times 100 \quad \text{--- 3.5}$$

3.5.3.4. Ascorbic acid (mg/100 ml)

The ascorbic acid in Passion fruit was estimated by using the detective dye 2, 6 dichlorophenol indophenol (DCPIP) by standardizing 0.1% standard, 2,6 DCPIP dye solution against 0.1% ascorbic acid solution according to the method described in AOAC (2000). The per cent ascorbic acid was computed according to the expression given below:

$$\text{Ascorbic acid, (mg/100ml)} = \frac{R_L \times V}{R \times W \times V_1} \times 100 \quad \text{--- 3.6}$$

R – ml of dye used in titration against one ml standard Ascorbic acid solution (1mg ascorbic acid/ml).

R_L – ml of dye used in titration against V_1 ml of aliquot.

V – Volume of aliquot made by 0.4% ascorbic acid.

W – ml sample.

V_1 – ml aliquot taken for titration.

3.5.3.5. Colour analysis

Colour of fruits plays an important role in fruit consumption and is one of the most important quality attributes in the selection process. Sometime colour influences flavour recognition and it affects consumer perception. Hunter lab colour flex meter (made by Hunter Associates Laboratory, Reston, Virginia, USA) was used for the measurement of colour. It works on the principle of

focusing the light and measuring the energy reflected from the sample across the entire visible spectrum. The colour meter has filters that rely on “standard observation curves” which defined the amount of red, yellow and blue colours. It provide readings in terms of parameters L, a, and b indicating degree of brightness, degree of redness (+a) or greenness (-a) and the degree of yellowness (+b) or blueness (-b) respectively (McGuire, 1992).



Plate 3. 1 Hunter lab colour flex meter

3.5.3.6. Texture analysis

Firmness is defined, as specific force required to deforming a fruit. The fruit, which is more firmed, shows less deformation from a given applied force. The measurement of texture is an important criteria and it can be measured with the help of TA.XT plus texture analyser (Stable micro systems Ltd.).



Plate 3. 2 Texture Analyser

The texture analyser is a microprocessor controlled texture analysis system. It measures force, distance and time, thus providing three dimensional product analysis. The probe carrier contains a very sensitive load cell. Compression platens were used for conducting the test. Size of the probe used was 5 mm at test speed of 2 mm/s.

3.5.3.7. Moisture content of juice and peel (m.c)

The moisture content of the pulp and peel is determined by oven dry method. The pulp and peel are weighed separately and kept in hot oven at a temperature of 70°C (Ssemwanga, 1994). The samples are weighed after 24 hrs. Then the samples are again kept in hot oven and again the samples are weighed after 48 hrs. If both the weights (i.e.) the weight after 24 hrs and the weight after 48 hrs are same, the weight is taken as final weights of the samples. The moisture content (m.c) is determined by the following method:

$$\text{Moisture content (\%)} = \frac{\text{Weight of water}}{\text{Weight of water} + \text{Weight of dry sample}} \times 100 \quad - -3.7$$

3.5.3.8. Appearance

Surface characteristics of food products contribute to appearance. Sight plays an important role in the assessment of fresh fruits. The fruits are visually assessed for shrivelling, decay and fungal growth.

3.5.4. Statistical Analysis

The results obtained during the course of experiment were subjected to the one-way Analysis of Variance (ANOVA). The statistical analysis of data was carried out by using software SPSS.

Results & Discussion

Chapter IV

Results and Discussion

The results of an experiment to develop a wax applicator for passion fruit are detailed in this chapter. The evaluation of wax applicator and postharvest behaviour of wax coated passion fruits during its storage period are also discussed.

4.1: Properties of passion fruit

The properties of passion fruit were determined by using the methodology described in section 3.2.

4.1.1. Sphericity

Sphericity (S_c) and aspect ratio ranged from 0.90 to 0.99 and 0.86 to 0.98 with mean values of 0.95 and 0.92 respectively. This was determined for designing the conveying equipment and the capacity of the feed hopper.

4.1.2. Surface area

The surface area is another important parameter for calculating the amount of wax required for coating the fruits and it was found to be $137.61 \pm 1.89 \text{ cm}^2$.

4.1.3. Angle of repose

The angle of repose determines the angle of inclination of the machine. The angle of repose of the fruits was found to be $4 \pm 2^\circ$. It should be less than the angle of inclination so that the movement of fruits from the feed hopper to the collecting tray will be smooth.

4.2. Development of wax applicator

Based on the properties of passion fruit, a wax applicator was designed and developed (Plate 4.1 & 4.2). The developed wax coating machine had the following components:

1. Feed hopper
2. Tank

3. Power source
4. Brushes
5. Collecting tray
6. Wax supply system
7. Main frame

4.2.1. Feed hopper

A feed hopper of size 36 x 18 x 33 cm was designed according to the dimensions of the fruit. The hopper was inclined slightly at an angle of 10°. The inclination was designed based on the sphericity and the angle of repose of the fruits.

4.2.2. Tank

A tank of capacity 5 litres was fixed at the bottom of the main frame. This was designed in such a way, to collect the excess wax after the application. The tank was also provided with a pipe at the bottom for collecting the remaining wax after the entire application.

4.2.3. Power source

Power was transmitted from the motor to the flywheel by means of a chain. The flywheel which was attached to the main shaft of the rollers and brushes rotated them in the clockwise direction so that the fruits were forwarded to the collecting tray.

4.2.4. Rollers and brushes

Three perforated rollers were used to transfer the excess wax sprayed over the fruit to the tank. There were followed by 3 roller brushes to ensure uniform application of wax and to avoid bruising of fruits.

4.2.5. Collecting tray

A rectangular collecting tray was kept next to the brushes, in order to collect the coated fruits.

4.2.6. Wax supply system

It consists of a centrifugal pump which transferred the wax from the tank to the spraying tube through a nylon hose. The spraying tube has a number of holes through which the wax was sprayed.

4.2.7. Main frame

The entire wax coating machine, rollers and brushes were fixed to an iron frame of size 57 x 52 x 75 cm. The frame was inclined at an angle of 12° which should be less than the angle of repose of the fruits for free movement of fruits.



Plate 4. 1 Side view of wax applicator

4.3. Evaluation of wax applicator

4.3.1. Capacity

The capacity of wax applicator was determined as per the method described in section 3.3.1. The average time taken for coating all the set of fruits was found to be 2.48 min and thus, the capacity of the applicator was found to be 250 kg/hr.

4.3.2. Mechanical damage

The mechanical damage of the fruits after coating was noted from the method mentioned in section 3.3.2. The fruits collected in the collecting tray after coating, were not damaged. This may be due to the absence of bruising between the fruits due to the presence of rollers covered with nylon bristles which provided a cushion effect.

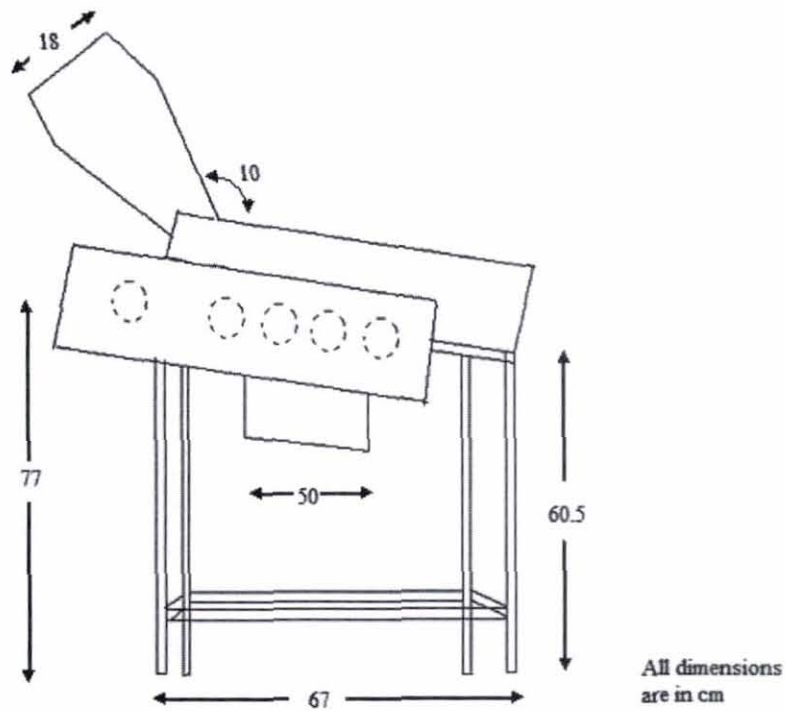

Figure 4. 1 Schematic diagram of wax applicator

4.3.3. Coating efficiency

The fruits after the application of wax were examined for finding the coating efficiency (section 3.3.3). The coated fruits were found to be fully covered with wax. This high coating efficiency was due to the presence of nylon brushes which uniformly spreads the wax over the surface of the fruits.



Plate 4.2 Top view of wax applicator

4.4. Postharvest behaviour of passion fruit during its storage period

The postharvest behaviour during storage of passion fruit in cold storage (7°C, 90% RH) and ambient conditions (32-35°C, 70-80% RH) were evaluated by finding the quality parameters as described in section 3.4.3. In the case of ambient storage conditions, the fruits kept for analysis shrivelled after the 10th day of analysis and hence they were discarded. At the same time, the fruits kept in cold conditions shrivelled after the fourth week of analysis and hence they were also discarded. However, the fruits kept as control cannot last for 2 days in the ambient condition and two weeks in cold conditions.

4.4.1. Physiological loss in weight (PLW)

The PLW of passion fruit occurs due to the reduction in moisture content. This leads to the formation of wrinkles on the rind and eventually increases the rate of shrinkage. The PLW increased consistently as a function of storage. The statistical results regarding the effect of different coating on PLW (%) have been

presented in Appendix I. Their respective values of PLW for each sample were plotted against the weeks to obtain the trend as shown in Fig. 4.1 and 4.2. The results indicated that the fruits showed significant variation ($P < 0.05$) in the PLW during storage.

4.4.1.1. Change in PLW of bee wax coated fruits under MAP

From the Fig. 4.1, the lowest PLW was observed for T6 (bee wax + LDPE 200 without perforation) i.e. 0.34% preceded by T2 (bee wax + LDPE 400 with 1% perforation) which was 4.42%, T5 (bee wax + LDPE 200 with 0.5% perforation) with 5.93% and so on in an increasing order, after the fourth week of storage. This minimum loss may be due to the combination of barrier properties of bee wax and LDPE bags (Kore and Kabir, 2012). From the above results, as the LDPE 200 bags were not perforated, the PLW was less. In the case of LDPE 400 bags, the perforations increased the rate of respiration. The increasing PLW trend was explained by the equation $PLW = 0.054x + 0.09$ ($R^2 = 0.7881$), where x is storage period (weeks). The highest PLW (11.13%) observed for T0 (bee wax alone), after the fourth week of storage may be due to the absence of LDPE bags, which enhanced the moisture migration and respiration rate. Similar results were reported by Hailu *et al.*, (2011).

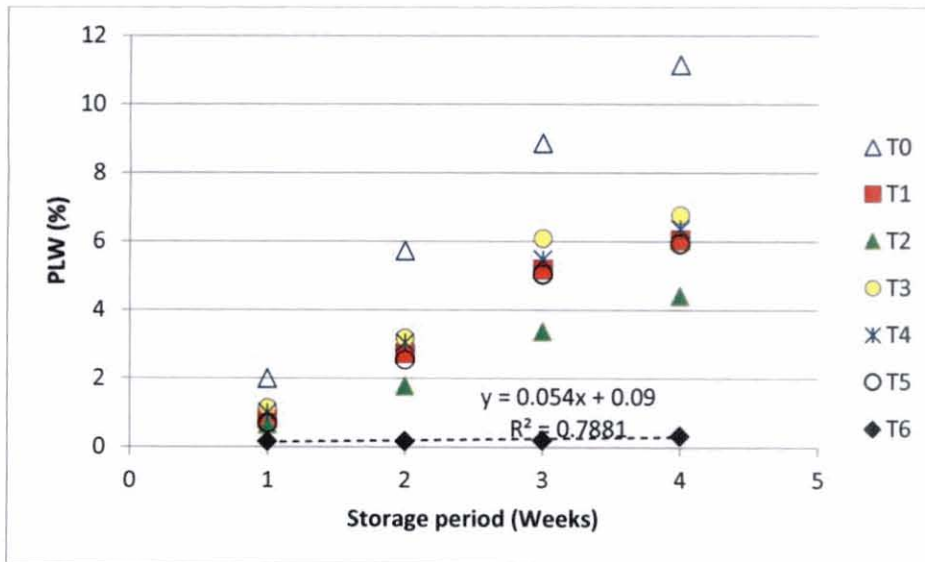

Fig. 4.2 Change in PLW of bee wax coated fruits

4.4.1.2. Change in PLW of uncoated fruits under MAP

The table 4.1 shows that the minimum weight loss after fourth week of storage was observed in T12 (LDPE 200 without perforation) with a mean of 1.82%. This was due to the property of LDPE to reduce water loss which was in accordance with the results of Aharoni, (2004). The mean PLW of uncoated fruits increased from 3.29% to a maximum of 19.56%. However, the maximum PLW was observed in control (T20) with 52.32% after the fourth week of storage. It was also noted that the PLW of the control exceeded 12% after the second week of storage, thus reducing its consumer acceptability (Wills *et al.*, 1998).

Table 4.1 Change in PLW of uncoated fruits

Treatments	Storage period (weeks)				Mean (%)
	1	2	3	4	
T7	3.27 ^c	8.72 ^c	14.43 ^c	19.36 ^c	11.45
T8	1.40 ^b	3.03 ^b	5.44 ^b	9.59 ^b	4.86
T9	4.02 ^f	10.67 ^f	18.65 ^f	26.43 ^f	14.94
T10	2.57 ^d	4.01 ^d	8.84 ^d	14.33 ^d	7.44
T11	1.96 ^c	3.91 ^c	6.81 ^c	11.07 ^c	5.94
T12	0.12 ^a	0.86 ^a	2.47 ^a	3.81 ^a	1.82
T20	9.66 ^g	14.58 ^g	31.75 ^g	52.32 ^g	27.07
Mean (%)	3.29	6.54	12.63	19.56	

4.4.1.3. Change in PLW of commercial wax coated fruits under MAP

From the Fig. 4.2, an increase in trend with the equation

$$PLW = 0.264x - 0.035 \quad (R^2 = 0.9852), \quad \text{-----4.1}$$

where x is storage period (weeks) was observed with the minimum deviation in T19 (commercial wax + LDPE 200 without perforation) with 0.99%. This significant variation may be due to the combined action of commercial wax and

LDPE bags in which the coating plugs the opening of the fruit skin surface thereby lowering the rate of respiration and transpiration and the LDPE bags offers some resistance to the exchange of gases. This was in conformity with the results of Claypool, (1939) and Silva *et al.*, (2009).

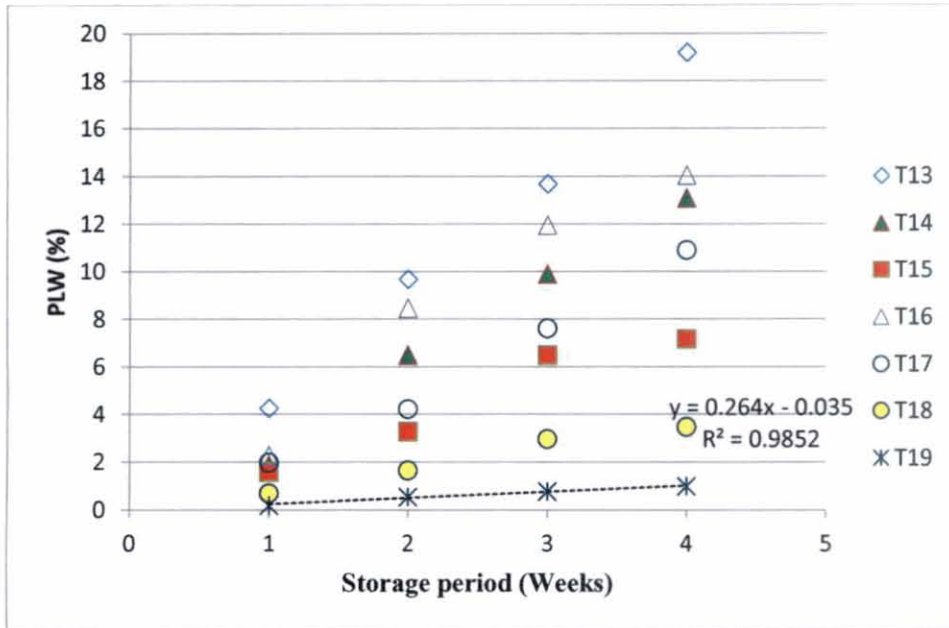

Fig. 4.3 Change in PLW of commercial wax coated fruits

Comparison of treatment means showed that maximum weight loss (52.32%) was observed in T20 (control) whereas the lowest (0.34%) was noted in T6 (Bee wax + LDPE 200 without perforation), which was close to that of T19 (commercial wax + LDPE 200 without perforation) with a PLW of 0.99%. The possible reason may be that bee wax and commercial wax served as a semi permeable membrane around fruit surface which resulted in reduction of water loss and rate of respiration, thereby reducing the moisture loss and hence the PLW. Among the bee wax and commercial wax, bee wax was found to be effective as the PLW of the bee wax coated fruits (0.5%) was less than that of commercial wax coated fruits (1%). These results were similar to the findings of Kaushal and Thakur (1996) who found that minimum weight loss can range upto 1.5% depending upon storage conditions and fruit coatings.

4.4.1.4. MAP of passion fruit in ambient storage condition

In ambient condition, the PLW of fruits were significant. The fruits kept in bags with more number of perforations started shrivelling after the 5th day of analysis itself and hence were discarded as was reported Shellhammer and Krochta (1997). From table 4.2, the minimum PLW (2.71%) was found in T12 followed by T6 (2.76%), T19 (2.78%) and so on. From the results, it was clear that LDPE bags without perforation and both bee wax and commercial wax in combination with LDPE bags were effective in acting as a barrier in controlling the respiration rate (Mollenhauer, 1954; Trout *et al.*, 1953). However, the maximum loss (10.34%) was noted in control after the 5th day of analysis. This sample showed maximum shrinkage and was discarded.

4.4.2. Total soluble solids

As expected, the TSS concentrations increased during ripening. The TSS during different storage periods was found to be significantly different. The ANOVA showing the variation of TSS with storage period have been presented in Appendix II.

4.4.2.1. Change in TSS of bee wax coated fruits under MAP

At the end of the storage period, the TSS of fruits in T0 (bee wax alone) was the highest i.e., 17.8° Brix. The lowest of 15.1° Brix was observed for T6 (bee wax + LDPE 200 without perforation) (Fig. 4.3).

Table 4.2 Change PLW of fruits in ambient storage

Treatment	Days of storage	
	5	10
T0	2.67 ⁱ	-
T1	1.50 ^c	3.41 ^e
T2	1.34 ^b	3.25 ^c
T3	1.82 ^e	-
T4	1.70 ^d	-
T5	1.40 ^b	3.31 ^d
T6	0.85 ^a	2.76 ^b
T7	3.95 ^l	-
T8	2.08 ^f	4.01 ^f
T9	4.70 ^m	-
T10	3.25 ^k	-
T11	2.64 ⁱ	4.55 ⁱ
T12	0.80 ^a	2.71 ^a
T13	4.94 ⁿ	-
T14	2.56 ^h	4.47 ^h
T15	2.27 ^g	4.18 ^g
T16	2.96 ^j	-
T17	2.66 ⁱ	-
T18	1.37 ^b	3.28 ^{cd}
T19	0.87 ^a	2.78 ^b
T20	10.34 ⁿ	-

The increasing trend was found to be closely related to each other with an equation $TSS = 0.27x + 13.8$ ($R^2 = 0.8526$), where x is storage period (weeks). The lowest TSS may be attributed to retarded respiration due to the modified atmosphere effect of the wax and LDPE (Mota *et al.*, 2003).

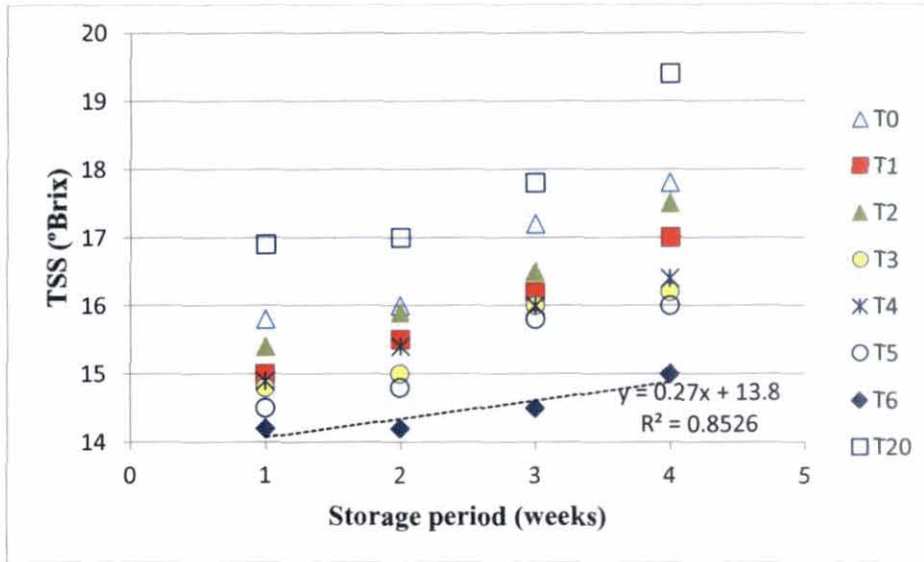

Fig. 4.4 Change in TSS of bee wax coated fruits

4.4.2.2. Change in TSS of uncoated fruits under MAP

The ANOVA pertaining to the effect of different sets of perforations on TSS of passion fruits presented in Table 4.3 indicated that the TSS significantly varied among the storage period. During the storage period, the fruits in T20 (control) was found to have the highest TSS (19.4° Brix). The treatments T12 (LDPE 200 without perforation) and T11 (LDPE with 0.5% perforation) had the lowest TSS (15.7° Brix). The lowest TSS may be due to the absence of perforation in T12 and less number of perforations (0.5%) in T11. This was in sequence with the findings of Cereda *et al.*, (1976). The mean TSS of uncoated fruits increased from a minimum of 15.34° Brix to a maximum of 16.25° Brix.

Table 4.3 Change in TSS of uncoated fruits

Treatments	Storage period (weeks)				Mean (°Brix)
	1	2	3	4	
T7	16.17 ^c	16.40 ^d	16.50 ^e	16.60 ^d	16.42
T8	15.23 ^c	15.63 ^b	15.93 ^c	15.93 ^b	15.68
T9	15.80 ^d	16.00 ^c	16.43 ^d	16.50 ^c	16.18
T10	16.47 ^f	16.80 ^e	16.80 ^f	17.07 ^e	16.78
T11	14.43 ^b	15.50 ^b	15.50 ^b	15.70 ^a	15.28
T12	14.23 ^a	14.80 ^a	15.00 ^a	15.70 ^a	14.87
T20	16.93 ^g	17.00 ^f	17.80 ^g	19.40 ^f	17.78
Mean (° Brix)	15.34	15.85	16.03	16.25	

4.4.2.3. Change in TSS of commercial wax coated fruits under MAP

The Fig. 4.4 clearly revealed that the lowest TSS was noted in T19 (commercial wax + LDPE without perforation) with 14.06°Brix after the fourth week of storage. This is perhaps due to the lowered respiration rate. Kader *et al.*, (1986) with pears, plums and nectarines and Nyambati (1984) with passion fruit found similar results. The increase in trend was explained by an equation

$$\text{TSS} = 0.18x + 13.6 \quad (R^2 = 0.8526), \quad \text{-----4.2}$$

where x – storage period (weeks).

The comparison of the effect of different types of waxes on TSS of fruits and uncoated fruits during its entire period of storage was plotted in Fig. 4.5. Fig. 4.5 showed that fruits kept in T19 yielded lowest TSS when compared to the fruits in T20 which exhibited highest TSS (19.4%) when tested after 4 weeks of storage. Control fruits showed maximum TSS from the first week of analysis. This higher TSS of fruits in T20 might be due to higher rate of respiration and evaporation (Thakur *et al.*, 2002). The graph clearly shows that T6, T12 and T19 have lower values when compared to that of controlled storage condition. The lower values

of TSS could be due to the low respiration rate of fruits which was in line with observation made by Hayat *et al.*, (2003).

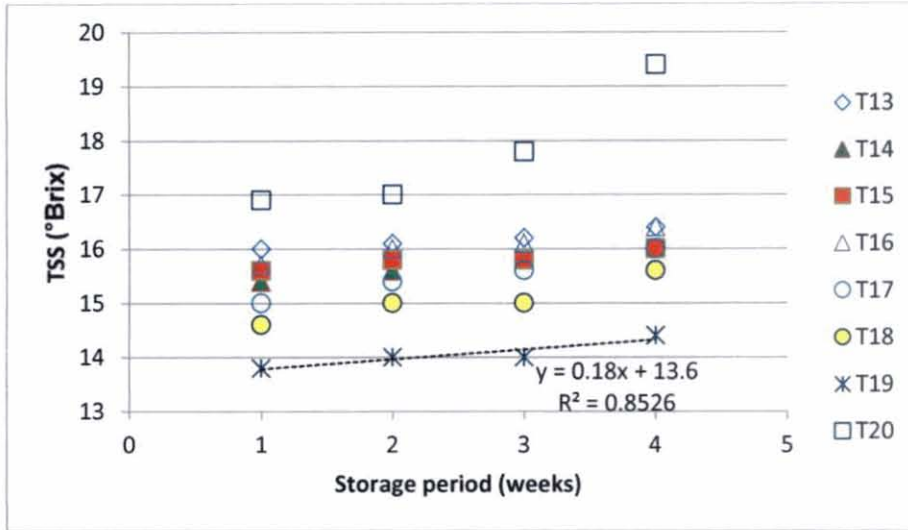

Fig. 4.5 Change in TSS of commercial wax coated fruits

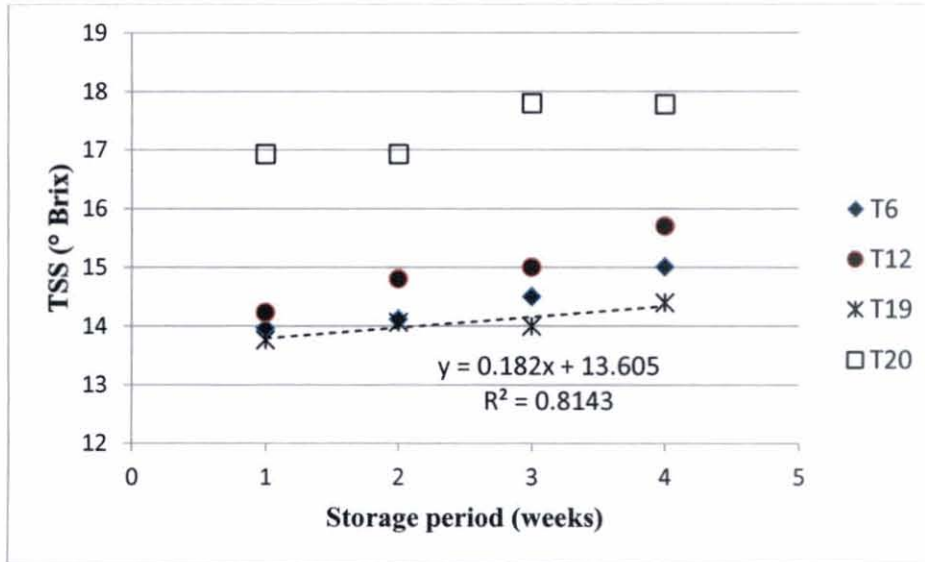

Fig. 4. 6 Change in TSS of coated/uncoated samples

4.4.2.4. MAP of passion fruit in ambient storage condition

The fruits kept in bags with more number of perforations started shrivelling after the 5th day of analysis itself and hence were discarded. As per the results presented in table 4.4, the minimum TSS was found to be in T19 with 14°

Brix. The TSS of fruits kept in non-perforated bags was found to be constant in the entire period of study. This may be due to the controlled rate of respiration. Thakur *et al.*, (2002); Alam and Paul, (2001) and Dou *et al.*, (1999) had reported similarly.

Table 4. 4 Change in TSS of fruits in ambient storage

Treatments	Days of storage	
	5	10
T0	16.00 ^j	-
T1	15.20 ^f	15.40 ^d
T2	15.63 ^h	15.63 ^e
T3	14.97 ^c	-
T4	15.17 ^f	-
T5	14.77 ^d	14.88 ^c
T6	14.43 ^c	14.43 ^b
T7	15.43 ^g	-
T8	16.37 ^l	16.77 ^g
T9	16.00 ^j	-
T10	14.17 ^b	-
T11	14.63 ^d	16.83 ^c
T12	16.77 ^m	16.77 ^g
T13	16.20 ^k	-
T14	15.57 ^{gh}	15.77 ^e
T15	15.80 ⁱ	16.00 ^f
T16	16.03 ^j	-
T17	15.17 ^f	-
T18	14.77 ^d	14.97 ^c
T19	13.97 ^a	13.97 ^a
T20	17.17 ⁿ	-

4.4.3. Titrable acidity

The titrable acidity in the control as well as in the coated fruits decreased with storage. This could be accounted for the degree of ripening of the fruits. However, the difference was to a lesser extent in coated fruit compared to control.

The effect of different coatings on acidity of fruits is shown in Appendix III. It is obvious from the statistical results that storage days, different wax treatments and different percent of perforations significantly affected the acidity of passion fruits.

4.4.3.1. Change in titrable acidity of bee wax coated fruits under MAP

The fruits in T6 (bee wax + LDPE without perforation) had high acidity (6.4%) and that in T0 (bee wax alone) showed least acidity (5.05%) (Fig.4.6). This maximum value of acidity may be due to the wax coating and non-perforated LDPE bags, which caused a delay in ripening of fruits (Marupadi *et al.*, 2011). The decreasing trend in acidity was expressed by the equation

$$\text{Acidity} = -0.58x + 8.56 \quad (R^2 = 0.9225), \quad \text{-----4.3}$$

where x – storage period (weeks).

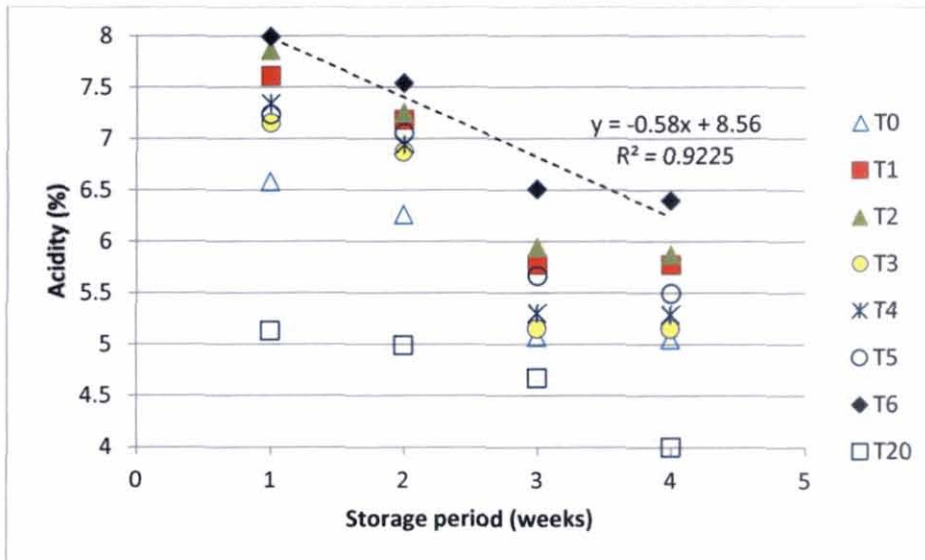

Fig. 4.7 Change in acidity of bee wax coated fruits

4.4.3.2. Change in titrable acidity of uncoated fruits under MAP

The uncoated fruits in T12 (LDPE 200 without perforation) showed the highest acidity (4.95%) with a maximum mean value of 5.74% (Table 4.5). This is due to the delayed ripening in CO₂ enriched MAP. The lowest acidity was found in control with 4.02% due to the enhanced ripening in the normal atmosphere (Raghavan *et al.*, 2003; Bender *et al.*, 2000). The mean acidity of uncoated fruits decreased from a maximum of 5.87% to a minimum of 4.6% during the period of storage.

Table 4.5 Change in acidity of uncoated fruits

Treatments	Storage period (weeks)				Mean (%)
	1	2	3	4	
T7	5.37 ^g	5.37 ^c	4.87 ^d	4.23 ^e	4.96
T8	5.62 ^d	5.56 ^c	5.00 ^c	4.43 ^d	5.15
T9	6.03 ^c	5.56 ^c	5.06 ^b	4.75 ^c	5.35
T10	5.49 ^e	5.48 ^d	4.89 ^d	4.41 ^d	5.07
T11	6.13 ^b	5.64 ^b	5.09 ^b	4.87 ^b	5.43
T12	6.57 ^a	5.96 ^a	5.51 ^a	4.95 ^a	5.74
T20	5.13 ^f	4.99 ^f	4.67 ^e	4.02 ^f	4.7
Mean (%)	5.87	5.59	5.07	4.6	

4.4.3.3. Change in titrable acidity of commercial wax coated fruits under MAP

The Fig. 4.7, clearly revealed that the minimum decrease in acidity (5.4%) was noted in T19 (commercial wax + LDPE 200 without perforation) followed by T18 (LDPE 200 with 0.5% perforation) with 5.23, T15 (LDPE 400 with 1% perforation) having 4.78 and so on. The decrease in trend can be explained by the equation $\text{Acidity} = -0.1867x + 6.18$ ($R^2 = 0.954$), where x is storage period (weeks). The acidity in T19 was lower because of the retarded ripening due to the

MA created by the wax and the LDPE bags which was in accordance with the Silva *et al.*, (2009); Akath *et al.*,(2007).

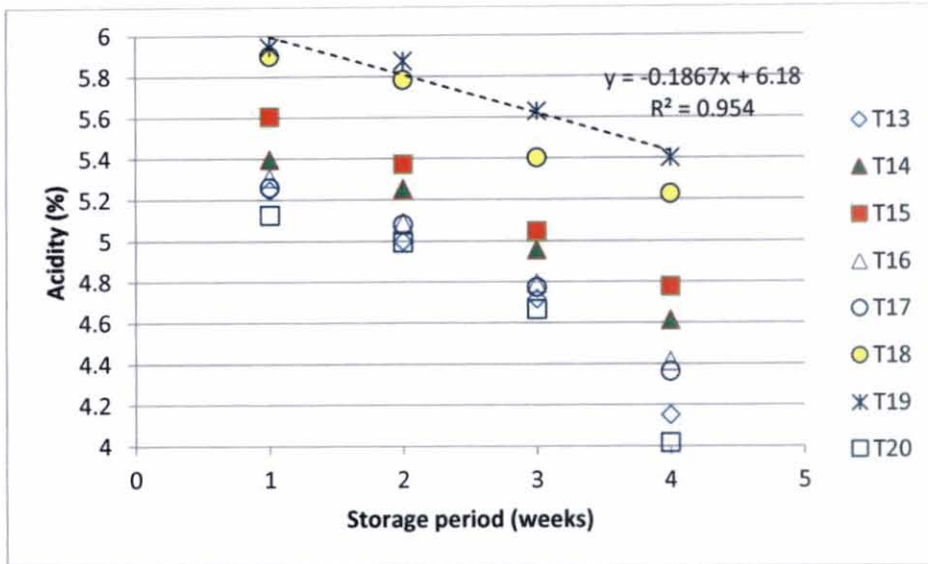

Fig. 4.8 Change in acidity of commercial wax coated fruits

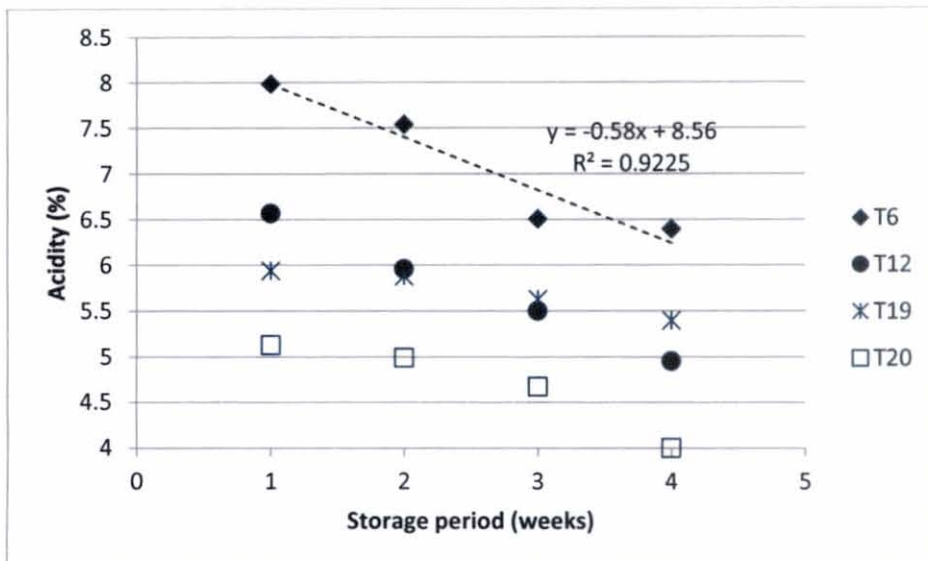

Fig. 4.9 Change in acidity of coated/uncoated samples

The interactive effects between storage days and treatments were shown in Fig. 4.8. There was a steep decrease in the case of T6 and T12. But in the case of T19 the variation was very less from the first week of analysis, till the fourth week of experimentation. The acidity in T6 was found to be the highest with 6.4%.

Among the treatments, T19 shows only slight deviation in acidity from the first week to the fourth week of study. But there was traces of fungal growth in the surface of bee wax coated fruits and hence T19 i.e., commercial wax coated fruits was found to be the best with the maximum value of 5.4%. This was in line with the observation made by El-Anany *et al.*, (2009). He stated that the wax coating fruits acts as a barrier and caused delay in ripening of fruits.

4.4.3.4. MAP of passion fruit in ambient storage condition

The fruits kept in bags with more number of perforations, started shrivelling after the 5th day of analysis and hence were discarded. The table 4.6 shows the acidity of fruits kept in ambient condition. The maximum acidity (5.78%) was found in T6 (bee wax + LDPE 200 without perforation) and the minimum acidity (3.75%) was found in T15 (commercial wax + LDPE 400 with 1% perforation) after the 10th day of analysis. The maximum acidity may be due to the retardation in ripening caused by the combination of both bee wax and LDPE bags (Wills *et al.*, 1998).

4.4.4. Colour

A significant change in colour was observed during the storage period of passion fruits. The degree of brightness (+L), greenness

(-a) and yellowness (+b) increased during the period of storage irrespective of the

Table 4. 6 Change in acidity of fruits kept in ambient storage

Treatments	Days of storage	
	5	10
T0	5.35 ^g	-
T1	6.38 ^c	5.06 ^d
T2	6.63 ^b	5.31 ^b
T3	5.92 ^f	-
T4	6.11 ^d	-
T5	6.00 ^c	5.23 ^c
T6	6.76 ^a	5.78 ^a
T7	4.90 ^h	-
T8	5.34 ^g	4.28 ^e
T9	4.80 ⁱ	-
T10	4.38 ^l	-
T11	4.14 ^o	3.96 ⁱ
T12	4.39 ^j	4.02 ^g
T13	4.67 ^k	-
T14	4.38 ^l	4.01 ^{gh}
T15	4.02 ^q	3.75 ^j
T16	4.08 ^p	-
T17	4.03 ^q	-
T18	4.17 ⁿ	5.00 ^h
T19	4.71 ^j	4.17 ^f
T20	3.90 ^r	-

treatments. Results and ANOVA for colour evaluation of L, a and b were presented in Appendix IV.

4.4.4.1. Change in colour of bee wax coated fruits under MAP

4.4.4.1.1. Effect of MAP and bee wax coating on lightness 'L' of passion fruits

Fig. 4.9 indicates the increase in L during the storage period of MA packed fruits. Among the treatments, T6 (bee wax + LDPE 200 without perforation), T2 (bee wax + LDPE 400 with 1% perforation) and T5 (bee wax + LDPE 200, 0.5% perforation) showed minimum change in L value. This was due to the coating and the presence of less number of perforations. The minimum value (54.52) was found in T6 and the maximum (73.08) was found in T0 after the fourth week of analysis. The trend in Fig. 4.9 also shows that there was a sharp increase in ΔL in the case of fruits in treatment T0 (bee wax alone) and T3 (bee wax + LDPE 200 with 2% perforation). This was due to the fast ripening of fruits. This was similar to the findings of Nanda *et al.*, (2001) and Ladaniya, (2001).

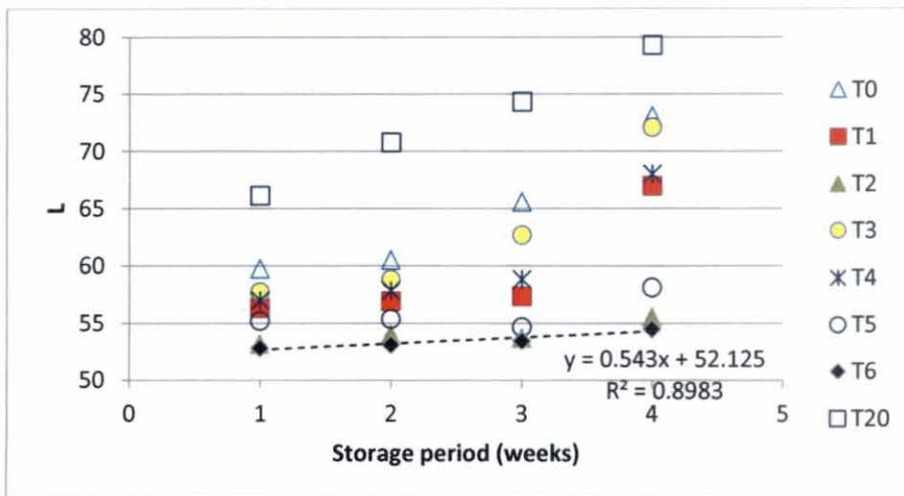

Fig. 4.10 Variation in lightness 'L' of bee wax coated fruits

4.4.4.1.2. Effect of MAP and bee wax coating on greenness 'a' of passion fruits

From the statistical analysis of bee wax coated fruits, most of the treatments were found to be on par as shown in Table 4.7. The mean a of T6 (bee wax + LDPE 200 without perforation) was found to be minimum (-10.59) and the

maximum (-6.92) was found in T0 (bee wax alone) after the fourth week of storage. This may be due to the delay in ripening caused by MAP & wax coating. This was in concordance with the findings of Randhawa *et al.*, (2009) and Dau *et al.*, (1999).

Table 4.7 Variation in greenness 'a' of bee wax coated fruits

Treatments	Storage period (weeks)				Mean
	1	2	3	4	
T0	-8.56 ^c	-7.16 ^g	-6.82 ^d	-5.15 ^{ab}	-6.92
T1	-10.35 ^{ab}	-8.69 ^a	-8.07 ^{bcd}	-7.03 ^a	-8.53
T2	-10.74 ^a	-9.55 ^c	-9.17 ^{ab}	-8.07 ^a	-9.38
T3	-9.87 ^b	-8.14 ^f	-7.12 ^{cd}	-6.36 ^{ab}	-7.87
T4	-10.39 ^{ab}	-9.09 ^d	-8.68 ^{bc}	-7.79 ^a	-8.99
T5	-11.04 ^a	-10.05 ^b	-9.51 ^{ab}	-8.28 ^a	-9.72
T6	-11.11 ^a	-10.58 ^a	-10.53 ^a	-10.14 ^a	-10.59
T20	-6.39 ^d	-4.14 ^h	-2.57 ^e	-1.39 ^b	-3.62
Mean	-10.29	-9.04	-8.56	-7.55	

4.4.4.1.3. Effect of MAP and bee wax coating on yellowness 'b' of passion fruits

From the Fig. 4.10, it is clearly understandable that all the b values are positive which shows the yellowness of stored fruits. The minimum value of b was found in T6 (29.68) with the increasing trend

$$b = 1.578x + 23.44 \quad (R^2 = 0.9948) \quad \text{-----4.4}$$

where x is storage period (weeks) and the maximum value (47.0) was observed in T0. Low value of yellowness shows that the fruits were not still ripened after the fourth week of analysis. This may be due to the retarded ripening of fruits kept in LDPE bags (Akath *et al.*, 2007). Plate 4.3 shows the change in colour in fruits after the first week of analysis.

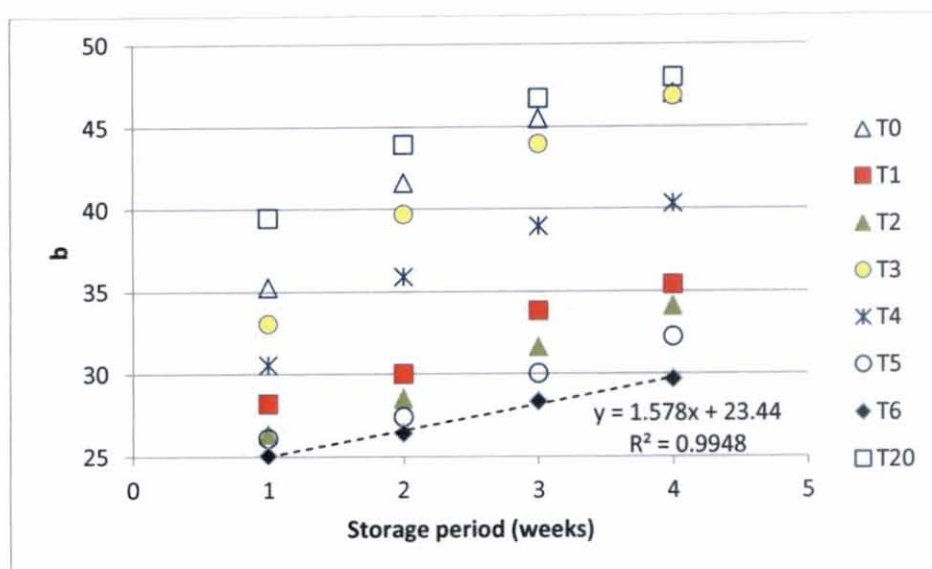

Fig. 4.11 Variation in yellowness 'b' of bee wax coated fruits



Plate 4.3 Fruits after first week of storage

4.4.4.2. Change in colour of uncoated fruits under MAP

4.4.4.2.1. Effect of MAP on lightness 'L' of fruits

The table 4.8 revealed that the fruits kept in T12 (LDPE without perforation) gave the lowest mean L i.e., 67.05. The lower value of T12 was due to the modification in the levels of O₂ and CO₂ as reported by Jobling, (2001). The maximum mean L (72.63) was found in T20 (control). The mean L of uncoated fruits increased from a minimum of 63.54 to a maximum of 75.53.

Table 4.8 Variation in lightness 'L' of uncoated fruits

Treatments	Storage period (weeks)				Mean
	1	2	3	4	
T7	65.27 ^d	70.55 ^{cd}	73.57 ^{ef}	78.90 ^d	72.07
T8	63.72 ^{bc}	67.23 ^{abc}	71.05 ^{bc}	74.55 ^b	69.14
T9	64.83 ^{cd}	69.95 ^{bcd}	72.74 ^{de}	76.86 ^c	71.10
T10	63.86 ^{bc}	67.59 ^{abcd}	71.86 ^{cd}	75.11 ^b	69.60
T11	62.64 ^b	66.86 ^{ab}	70.34 ^{ab}	74.88 ^b	68.68
T12	60.90 ^a	65.24 ^a	69.19 ^a	72.85 ^a	67.05
T20	66.14 ^e	70.79 ^{cd}	74.31 ^f	79.27 ^d	72.63
Mean	63.54	67.90	71.46	75.53	

4.4.4.2.2. Effect of MAP on greenness 'a' of passion fruit

Fig. 4.11 shows a regular increase in trend of a with the equation $a = 1.369x - 11.455$ ($R^2 = 0.9615$), where x is storage period (weeks). The interactive effect between the different sets of perforations showed that the lowest mean value of a (-8.03) was found in T12 (LDPE without perforation), whereas the highest mean value (-3.62) was found in T20 (control) after fourth week of storage. The lowest value indicates the greenness which was due to the creation of MA around the fruits (Mir and Beaudry, 2009).

4.4.4.2.3. Effect of MAP on yellowness 'b' of uncoated passion fruits

The statistical results regarding the effect of MAP on b of fruits indicated that b was significantly affected by the storage period (Table 4.9). The values of T12 (LDPE without perforation) and T11 (LDPE with 0.5% perforation) were found to be minimum (35.15 & 40.09) and was on par. This was due to the controlled rate of respiration of fruits generated by the MA around the fruits. Similar results were observed by Singh *et al.*, 1998). The minimum mean (35.59) found to be T12 whereas the maximum (47.95) was found to be in T20 (control).

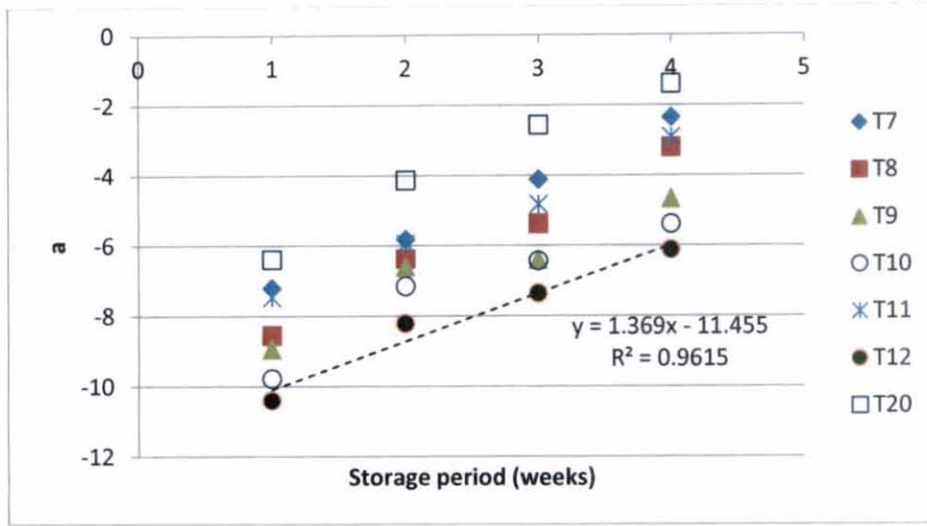

Fig. 4.12 Variation in greenness 'a' of uncoated fruits



Plate 4.4 Fruits after second week of storage

4.4.4.3. Change in colour of commercial wax coated fruits under MAP

4.4.4.3.1. Effect of MAP and commercial wax on lightness 'L' of passion fruits

The deviation of L during the storage period in commercial wax coated fruits was indicated in Fig. 4.12. During the first 3 weeks of study, the degree of brightness of T19 (commercial wax + LDPE without perforation) was found to be on par with T18 (commercial wax + LDPE 200, 0.5% perforation) and T15 (c.w + LDPE 400, 1% perforation). This was due to the controlled transpiration rate of

wax and LDPE bags (Santana *et al.*, 2011; Petracek *et al.*, 1998). After the fourth week of storage, the minimum value was found to be in T19 with 68.05 followed by T18 with 69.89. However, the higher value was found in T13 (commercial wax alone) with 77.71. Plate 4.4 shows variation in colour of fruits after second week of analysis.

Table 4.9 Variation in yellowness 'b' of uncoated fruits

Treatments	Storage period (weeks)				Mean
	1	2	3	4	
T7	36.53 ^d	40.45 ^{cd}	43.15 ^c	44.11 ^c	41.06
T8	33.96 ^{bc}	36.84 ^{ab}	39.78 ^b	41.98 ^b	38.14
T9	37.81 ^e	42.00 ^{de}	45.57 ^d	46.90 ^d	43.07
T10	35.16 ^c	37.79 ^{bc}	41.72 ^c	42.87 ^{bc}	39.38
T11	32.83 ^b	35.71 ^{ab}	38.05 ^{ab}	40.09 ^a	36.67
T12	30.92 ^a	34.60 ^a	37.72 ^a	39.15 ^a	35.59
T20	39.49 ^f	43.94 ^e	46.72 ^d	47.95 ^d	44.53
Mean	34.54	37.90	40.99	42.52	

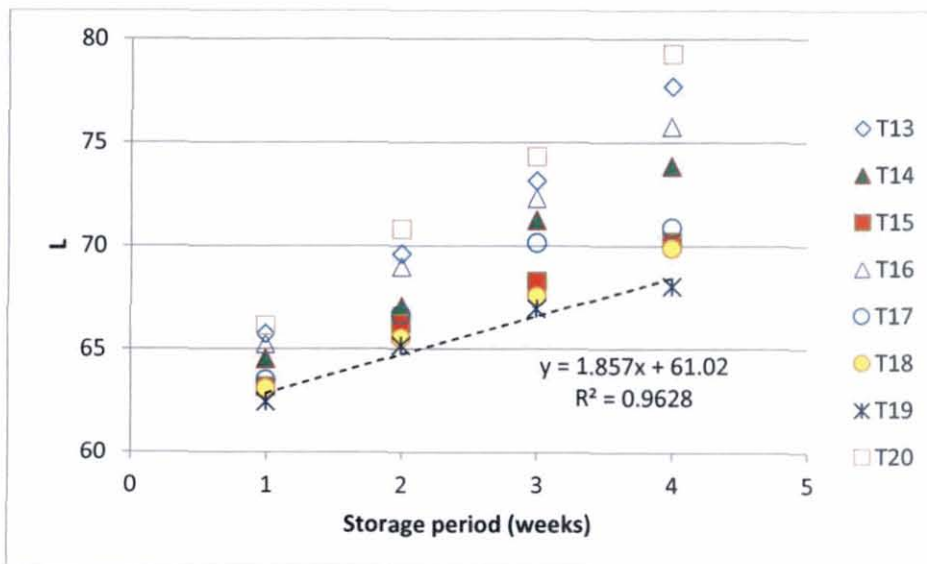

Fig. 4.13 Variation in lightness 'L' of commercial wax coated fruits**4.4.4.3.2. Effect of MAP and commercial wax on greenness 'a' of passion fruits**

The statistical results for ANOVA regarding the effect of different treatments shown in Table 4.10 indicated that a was affected significantly by storage days and different sets of perforations. The minimum mean (-9.68) was found to be in T19 and the maximum (-4.61) was found in T13. This shows that the greenness was high in T19 after the fourth week of analysis. This was due to the delayed ripening caused by the MA of commercial wax and LDPE bags which was in accordance with the findings of Krochta (1997).

Table 4.10 Variation in greenness 'a' of commercial wax coated fruits

Treatments	Storage period (weeks)				Mean
	1	2	3	4	
T13	-8.56 ^d	-4.75 ^c	-3.13 ^{ef}	-2.00 ^{tg}	-4.61
T14	-10.02 ^{ab}	-8.73 ^b	-7.31 ^b	-6.60 ^b	-8.16
T15	-9.15 ^{cd}	-5.94 ^d	-3.62 ^e	-3.15 ^{ef}	-5.46
T16	-9.45 ^{bcd}	-7.49 ^c	-5.91 ^d	-4.99 ^{cd}	-6.95
T17	-9.98 ^{abc}	-8.05 ^{bc}	-7.08 ^c	-6.17 ^{bc}	-7.82
T18	-9.11 ^d	-6.97 ^{cd}	-4.97 ^d	-4.50 ^{de}	-6.39
T19	-10.67 ^a	-9.94 ^a	-9.85 ^a	-8.28 ^a	-9.68
T20	-6.39 ^e	-4.14 ^e	-2.57 ^f	-1.39 ^g	-3.62
Mean	-9.55	-7.41	-5.98	-5.10	

4.4.4.3.3. Effect of MAP and commercial wax on yellowness 'b' of passion fruit

The results of different sets of treatments on b of passion fruits have been presented in Fig. 4.13. The lowest b (37.09) was found to be in T19 (LDPE without perforation) followed by T18 (LDPE 200 gauge, 0.5% perforation), T15 (LDPE 400 gauge, 1% perforation) and so on. The highest b (42.75) was found in T13 (without LDPE) after the period of study. The increase in trend was shown

by the equation $b = 1.607x + 33.07$ ($R^2 = 0.9862$), where x is storage period in weeks. Silva *et al.*, (2009) obtained the same result on yellow passion fruit coated with fruit wax. The variation in colour of fruits after third week of analysis was shown in Plate 4.5.

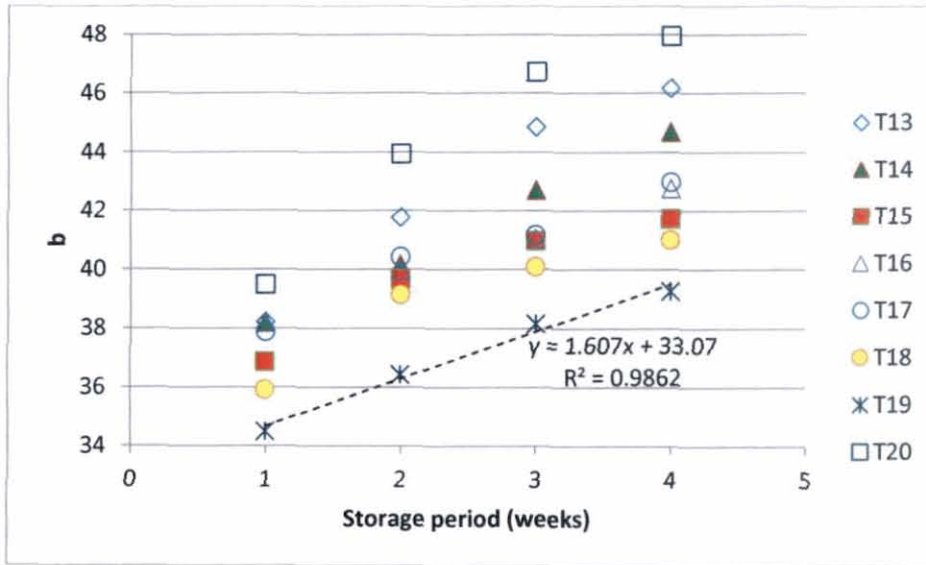

Fig. 4.14 Variation in yellowness 'b' of commercial wax coated fruit

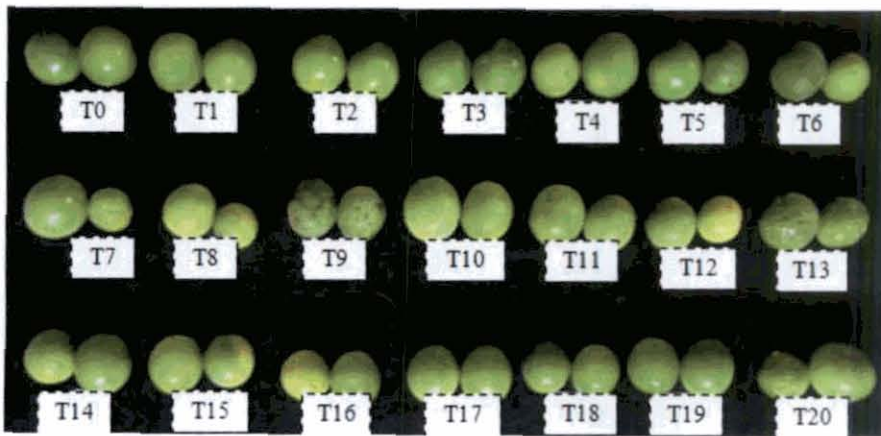

Plate 4.5 Fruits after third week of storage

4.4.4.4. MAP of passion fruit in ambient storage condition

The results pertaining to the interactive effect of different treatments on colour parameters of fruits kept in ambient condition was shown in Table 4.11. The minimum of L was found to be in T6 (bee wax + LDPE without perforation)

Table 4.11 Variation in colour parameters of fruits kept in ambient storage

Treatments	Days of storage					
	L		a		b	
	5	10	5	10	5	10
T0	61.04 ^{def}	-	-7.29 ^h	-	36.53 ^{abc}	-
T1	57.61 ^{abcd}	58.93 ^b	-9.08 ^{abcd}	-7.19 ^{ab}	29.49 ^{abc}	32.05 ^b
T2	54.44 ^{ab}	55.76 ^a	-9.47 ^{ab}	-7.58 ^{ab}	27.64 ^{ab}	30.20 ^a
T3	59.00 ^{cde}	-	-8.60 ^{cdef}	-	34.31 ^{abc}	-
T4	58.29 ^{bcde}	-	-9.12 ^{abcd}	-	31.83 ^{abc}	-
T5	56.48 ^{abc}	57.80 ^{ab}	-9.77 ^a	-7.88 ^a	27.40 ^{ab}	29.96 ^a
T6	54.11 ^a	55.43 ^a	-9.84 ^a	-7.95 ^a	26.34 ^a	28.90 ^a
T7	66.56 ^{gh}	-	-5.94 ⁱ	-	37.80 ^{abc}	-
T8	65.00 ^{gh}	69.89 ^{cd}	-7.28 ^h	-5.39 ^c	35.23 ^{abc}	37.79 ^c
T9	66.11 ^{gh}	-	-7.67 ^{gh}	-	39.08 ^{bc}	-
T10	65.14 ^{gh}	-	-8.51 ^{def}	-	36.43 ^{abc}	-
T11	63.92 ^{gh}	68.81 ^{cd}	-6.20 ⁱ	-4.31 ^d	34.13 ^{abc}	36.66 ^c
T12	62.18 ^{efg}	67.07 ^c	-9.14 ^{abcd}	-7.25 ^{ab}	32.19 ^{abc}	34.75 ^b
T13	67.00 ^h	-	-7.29 ^h	-	39.48 ^{bc}	-
T14	65.81 ^{gh}	70.70 ^d	-8.75 ^{bcde}	-6.86 ^b	39.47 ^{bc}	42.03 ^d
T15	64.46 ^{gh}	69.35 ^{cd}	-7.88 ^{fgh}	-5.99 ^c	38.13 ^{abc}	40.69 ^d
T16	66.52 ^{gh}	-	-8.14 ^{efg}	-	39.45 ^{bc}	-
T17	64.80 ^{gh}	-	-8.71 ^{bcde}	-	39.14 ^{bc}	-
T18	64.39 ^{gh}	69.28 ^{cd}	-7.84 ^{fgh}	-5.95 ^c	37.18 ^{abc}	39.74 ^c
T19	63.74 ^{gh}	68.63 ^{cd}	-9.40 ^{abc}	-7.51 ^{ab}	35.76 ^{abc}	38.32 ^c
T20	67.42 ^h	-	-5.12 ^j	-	40.76 ^c	-

with a value of 55.43 followed by T2 (bee wax + LDPE 400 gauge with 1% perforation) with a value of 55.76 after the 10th day of analysis. Similarly, the

minimum value of a and b were found to be in T6 with a values of -7.95 and 28.9 respectively followed by T5 (bee wax + LDPE 200 gauge with 0.5% perforation) with values of -7.88 and 28.96 respectively. This shows that there was a delay in ripening due to the MA created by the combination of bee wax and LDPE bags (Nanda *et al.*, 2001).

4.4.5 Pulp moisture content

The m.c of pulp showed significant difference during the period of study (Appendix V). The m.c of the pulp decreases during the entire storage period. There was a slight increase in the initial analysis and this was due to the penetration of moisture from the peel to the pulp.

4.4.5.1. Change in pulp m.c of bee wax coated fruits under MAP

Table 4.12 shows the statistical values of m.c of bee wax coated fruits. T6 (without perforation) showed highest m.c of 71.52% followed by T5 (LDPE with 0.5% perforation) (70.14%), T4 (LDPE with 1% perforation) (69%) and so on.

Table 4.12 Change in pulp m.c of bee wax coated fruits

Treatments	Storage period (weeks)				Mean
	1	2	3	4	
T0	67.27 ^g	68.64 ^g	66.39 ^g	64.97 ^g	66.82
T1	70.06 ^f	71.18 ^f	67.21 ^f	65.80 ^f	68.56
T2	71.03 ^e	72.39 ^e	67.77 ^e	65.99 ^e	69.30
T3	72.03 ^d	73.30 ^d	68.20 ^d	66.95 ^d	70.12
T4	72.78 ^c	73.90 ^c	69.59 ^c	69.00 ^c	71.32
T5	74.59 ^b	75.53 ^b	71.19 ^b	70.14 ^b	72.86
T6	75.98 ^a	76.69 ^a	72.99 ^a	71.52 ^a	74.29
T20	65.99 ^h	66.60 ^h	62.99 ^h	60.81 ^h	64.10
Mean	71.96	73.09	69.05	67.76	

The mean m.c of pulp initially increased from 71.96% to 73.09% and then it decreased to 67.76%. The highest m.c was due to the retention of moisture by the coating and LDPE bags (Santana *et al.*, 2011; Thirupathi *et al.*, 2006). The minimum mean m.c was observed in T0 (bee wax alone) (66.82%).

4.4.5.2. Change in pulp m.c of uncoated fruits under MAP

Fig. 4.14 shows that minimum decrease in trend was found to be in T12 (without perforation) during the period of study and it was indicated by the equation $m.c = -1.928x + 78.435$ ($R^2 = 0.9812$), where x is storage period (weeks). The maximum mean m.c (73.61%) was found in T12 (without perforation) while the minimum mean m.c (64.10) was found in T20 (control) with (Appendix V). The mean decrease in m.c was found to be from 74.24% to 65.28% during the period of experimentation. This result was an effect of greater dehydration of the fruit (Echeverria *et al.*, 2009).

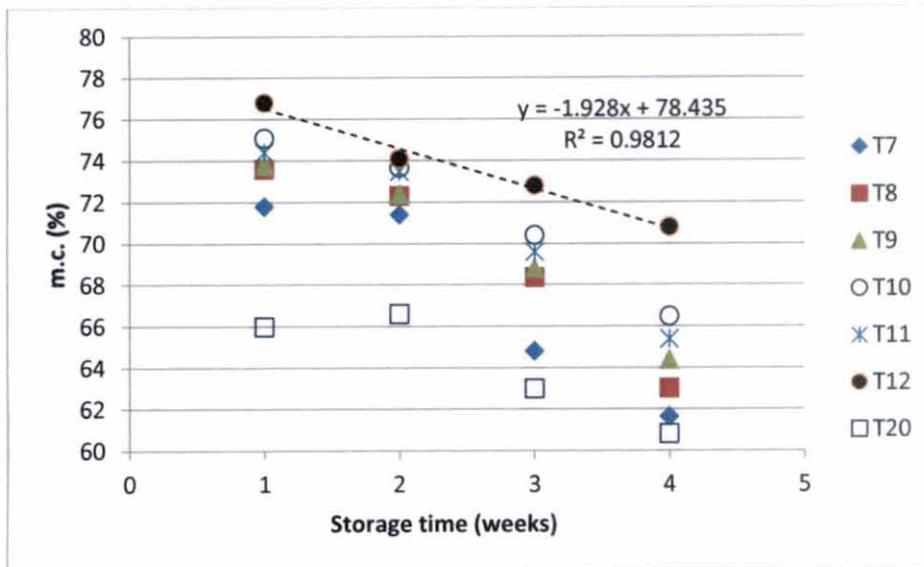

Fig. 4.15 Change in pulp m.c of uncoated fruits

4.4.5.3. Change in pulp m.c of commercial wax coated fruits under MAP

The effect of MAP and commercial wax coating on the m.c (pulp) was presented in Table 4.13. The highest mean of m.c (73.60%) was observed in T19 (without perforation). The minimum mean (67.47%) was found in T13

(commercial wax alone). This minimum value may be due to the absence of packaging material whereas, in T19 both commercial wax and LDPE bags acts as a barrier in controlling evapo-transpiration and thus retaining the moisture. Similar results were reported by Ding *et al.*, (2002) and Meir *et al.*, (1992).

Table 4.13 Change in pulp m.c of commercial wax coated fruits

Treatments	Storage period (weeks)				Mean
	1	2	3	4	
T13	70.59 ^g	69.15 ^g	67.40 ^g	62.74 ^f	67.47
T14	73.06 ^c	72.99 ^c	69.80 ^c	63.60 ^c	69.86
T15	75.59 ^a	73.40 ^d	70.60 ^d	63.72 ^d	70.82
T16	72.47 ^f	71.57 ^f	68.19 ^f	63.59 ^c	68.95
T17	74.60 ^d	73.95 ^c	71.79 ^c	65.98 ^c	71.58
T18	75.19 ^c	74.52 ^b	72.19 ^b	68.39 ^b	72.57
T19	75.38 ^b	75.42 ^a	73.79 ^a	69.81 ^a	73.60
T20	65.99 ^h	66.60 ^h	62.99 ^h	60.81 ^g	64.10
Mean	73.84	73.00	70.54	65.40	

The change in pulp m.c of both the coated and uncoated fruits was nearly same and this was due to the presence of the peel which acts as the natural barrier to control the moisture loss.

4.4.5.4. MAP of passion fruit in ambient storage condition

The results regarding the effect of different treatments in ambient condition have been presented in Table 4.14. The maximum m.c was observed in T6 (70.29%) followed by T19 (70.19%) after the 10th day of analysis. This maximum m.c of the coated fruits was due to the reduced rate of water loss (Ding *et al.*, 2002). These results were found to be similar to that of fruits kept in cold condition. However, after the first stage of analysis, the fruits kept in bags with more number of perforations were discarded as they lost its consumer's appeal.

Table 4. 14 Change in pulp m.c of fruits kept in ambient storage

Treatments	Days of storage	
	5	10
T0	65.04 ^f	-
T1	67.83 ^q	64.37 ^k
T2	68.80 ^o	65.34 ^j
T3	69.80 ^m	-
T4	70.55 ^k	-
T5	72.36 ^f	68.90 ^c
T6	73.75 ^b	70.29 ^a
T7	69.56 ⁿ	-
T8	71.38 ⁱ	66.92 ⁱ
T9	71.56 ^h	-
T10	72.84 ^e	-
T11	72.16 ^g	67.70 ^g
T12	74.56 ^a	70.10 ^b
T13	68.36 ^p	-
T14	70.83 ^j	67.37 ^h
T15	71.36 ⁱ	67.90 ^f
T16	70.24 ^l	-
T17	72.37 ^f	-
T18	72.96 ^d	69.50 ^d
T19	73.15 ^c	69.69 ^c
T20	63.76 ^s	-

4.4.6 Peel moisture content

There was a decrease in m.c of the peel during the duration of storage. The results obtained statistically, clearly shows that there was a significant variation in m.c among the treatments.

4.4.6.1. Change in peel m.c of bee wax coated fruits under MAP

Table 4.15 shows the variation of peel m.c of bee wax coated fruits. From the table it is clear that during first two weeks of analysis, there was only a slight decrease in m.c which later decreased drastically with a mean decrease of 84.69% to 84.27% finally to 82.97%. The higher peel m.c was found in T6 (without perforation) with a mean of 86.36% after the period of study. Similarly, the lower peel m.c was found in T0 (bee wax alone) with a mean of 81.50%. The variation was due to the development of MAP around the fruits kept in T6 (Singh *et al.*, 1998).

Table 4. 15 Change in peel m.c of bee coated fruits

Treatments	Storage period (weeks)				Mean
	1	2	3	4	
T0	82.99 ^g	82.03 ^g	81.68 ^g	79.30 ^g	81.50
T1	83.77 ^c	83.20 ^c	83.01 ^c	82.88 ^e	83.22
T2	85.27 ^c	85.09 ^c	84.65 ^c	83.90 ^c	84.73
T3	84.32 ^d	84.66 ^d	83.67 ^d	83.49 ^d	84.03
T4	83.18 ^f	82.26 ^f	81.96 ^f	80.45 ^f	81.96
T5	86.37 ^b	86.09 ^b	84.92 ^b	84.79 ^b	85.54
T6	86.93 ^a	86.54 ^a	85.98 ^a	85.98 ^a	86.36
T20	80.12 ^h	79.76 ^h	78.74 ^h	72.46 ^h	77.77
Mean	84.69	84.27	83.69	82.97	

4.4.6.2. Change in peel m.c of uncoated fruits under MAP

Fig. 4.15 shows the deviation of m.c during the entire period of study of uncoated fruits. The mean m.c decreased from a maximum of 82.91% to a minimum of 78.05% (Appendix V). The m.c increased initially and this may be due to the absorption of moisture from the surrounding. Then drastic decrease in m.c was observed after the second week of analysis. The maximum mean

(84.51%) m.c was found to be in T12 (without perforation). This was due to the controlled rate of evaporation. These results were comparable with that of Hailu *et al.*, (2011). However, the minimum m.c was obtained in T20 (control) with 72.46%. The decreasing trend can be shown by the equation

$$m.c = -1.268x + 82.55 \quad (R^2 = 0.7164) \quad \text{-----4.5}$$

where x – storage period (weeks)

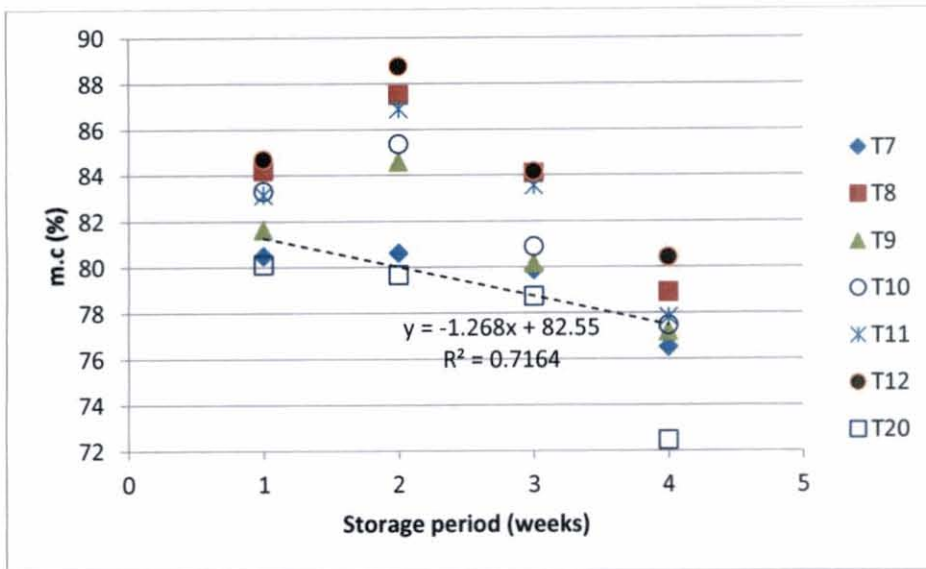

Fig. 4.16 Change in peel m.c of uncoated fruits

4.4.6.3. Change in peel m.c of commercial wax coated fruits under MAP

The peel m.c of commercial wax coated fruits has been shown in table 4.16. The mean decrease in m.c was from 85.73% to 78.88% with the maximum mean (85.04%) observed in T19 (without perforation). The highest value was due to the moisture retention property of wax coating and plastic packaging on fruits (Silva *et al.*, (2011); Fonesca *et al.*, (2000)). Conversely, the minimum mean was noted in T13 (commercial wax alone) (79.65%).

Table 4.16 Change in peel m.c of commercial wax coated fruits

Treatments	Storage period (weeks)				Mean (%)
	1	2	3	4	
T13	81.34 ^g	80.73 ^g	79.45 ^g	77.09 ^g	79.65
T14	86.10 ^d	83.95 ^d	82.36 ^d	78.75 ^d	82.79
T15	85.67 ^c	82.09 ^c	81.25 ^e	78.60 ^c	81.90
T16	85.02 ^f	81.11 ^f	80.66 ^f	78.11 ^f	81.22
T17	87.04 ^c	84.09 ^c	82.71 ^c	78.82 ^c	83.16
T18	87.16 ^b	85.95 ^b	84.16 ^b	79.82 ^b	84.27
T19	87.77 ^a	86.97 ^a	84.46 ^a	80.95 ^a	85.04
T20	80.12 ^h	79.76 ^h	78.74 ^h	72.46 ^h	77.77
Mean (%)	85.73	83.55	82.15	78.88	

4.4.6.4. MAP of passion fruit in ambient storage condition

Similar results regarding the effect of different treatments in ambient condition have been revealed in Table 4.17. The maximum M.C was observed in T19 with 83.04% followed by T6 with 82.2% after the 10th day of analysis (Ladaniya, 2001). However, the fruits kept in bags with more number of perforations were discarded, as the rate of shrinkage was more after the 5th day of analysis. Also, the fruits kept as control cannot last for more than 2 days.

4.4.7 Ascorbic acid

Concentration of ascorbic acid decreases as the fruit ripens. The statistical results for ascorbic acid content of passion fruits presented in Appendix VI indicated that ascorbic acid was significantly affected by the storage days and different treatments ($P < 0.05$).

Table 4.17 Change in peel m.c of fruits kept in ambient storage

Treatments	Days of storage	
	5	10
T0	81.72 ^q	-
T1	82.50 ^m	79.04 ^h
T2	84.00 ^h	80.54 ^g
T3	83.05 ^k	-
T4	81.91 ^o	-
T5	85.10 ^e	81.64 ^d
T6	85.66 ^d	82.20 ^c
T7	79.23 ^t	-
T8	82.93 ^l	78.47 ^j
T9	80.38 ^r	-
T10	82.02 ⁿ	-
T11	81.87 ^p	77.41 ^k
T12	83.43 ^j	78.97 ⁱ
T13	80.07 ^s	-
T14	84.84 ⁱ	81.38 ^e
T15	84.40 ^g	80.94 ^f
T16	83.75 ⁱ	-
T17	85.77 ^c	-
T18	85.89 ^b	82.44 ^b
T19	86.51 ^a	83.04 ^a
T20	78.85 ^u	-

4.4.7.1. Change in ascorbic acid of bee wax coated fruits under MAP

Table 4.18 shows the effect of bee wax coated fruits on ascorbic acid. The mean ascorbic acid varies from 29mg/100ml to 32.57mg/100ml. The minimum mean was observed in T6 (bee wax wax + LDPE 200 without perforation) with a value of 29.18mg/100ml. The mean of all other treatments except T0 (without LDPE bags) were found to be around 30-31mg/100ml. The minimum value was due to the inhibited respiration rate of fruits. Mahajan *et al.*, (2005) also reported similar results in 'Kinnows'.

Table 4.18 Change in ascorbic acid of bee wax coated fruits

Treatments	Storage period (weeks)				Mean
	1	2	3	4	
T0	40.58 ^f	38.51 ^e	30.00 ^c	21.19 ^e	32.57
T1	37.79 ^d	37.51 ^d	27.39 ^b	19.99 ^c	30.67
T2	37.58 ^c	37.51 ^d	27.40 ^b	19.99 ^c	30.62
T3	38.95 ^e	37.50 ^d	27.40 ^b	20.00 ^c	30.96
T4	37.53 ^b	37.45 ^c	27.66 ^b	20.13 ^d	30.69
T5	37.75 ^d	36.14 ^b	27.29 ^b	19.00 ^b	30.04
T6	36.78 ^a	36.06 ^a	25.01 ^a	18.89 ^a	29.18
T20	42.57 ^g	40.51 ^f	32.00 ^d	24.91 ^f	35.00
Mean	38.14	37.24	27.45	19.88	

4.4.7.2. Change in ascorbic acid of uncoated fruits under MAP

The trend obtained from the change in ascorbic acid values of uncoated fruits were shown in Fig. 4.16. The decrease in trend can be depicted by the equation $\text{Ascorbic acid} = -5.719x + 45.602$ ($R^2 = 0.9085$), where x is storage period (weeks). The ascorbic acid of T12 (without perforation) was found to be lower with 31.30 mg/100 ml and it was found to be decreasing from 38.34 mg/100 ml to 23.61 mg/100 ml. This was due to the controlled rate of metabolic activities of non-perforated bags (Thakur *et al.*, 1996). On the other hand, the higher ascorbic acid was found in T20 (control) with 24.91mg/100ml.

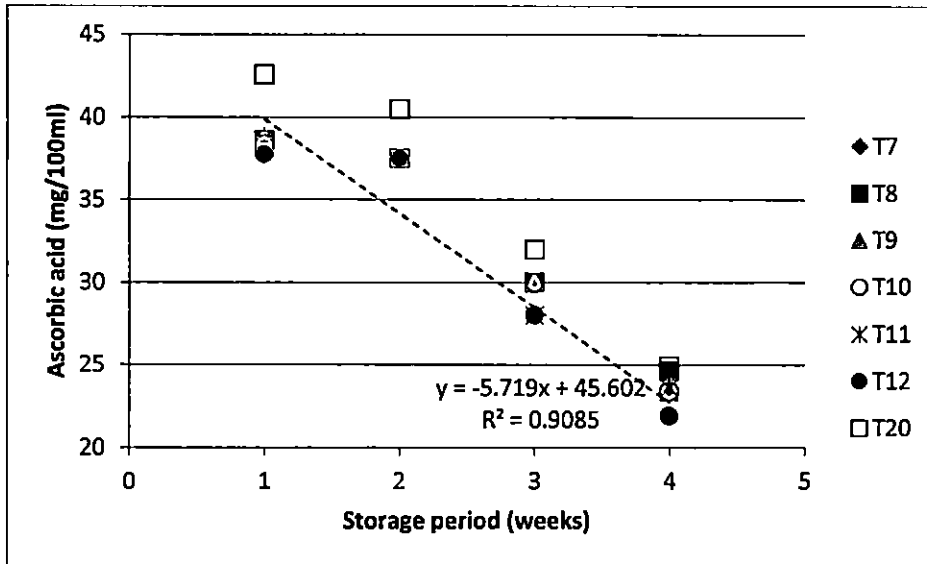

Fig. 4.17 Change in ascorbic acid of uncoated fruits

4.4.7.3. Change in ascorbic acid of commercial wax coated fruits under MAP

Table 4.19 revealed the ascorbic acid content of commercial wax coated fruits. The mean ascorbic acid content was found to be lower (24.77 mg/100 ml) in T19 (without perforation) yet the higher (32.09 mg/100 ml) was observed in T13 (commercial wax alone). The variation in ascorbic acid may be due to the slow down in respiration created by the MA of the commercial wax and the plastic packaging fruits. In the present study the ascorbic acid content have demonstrated a slight reduction during storage which has also been reported by Ladaniya (2006) i.e., 33.3 mg/100 ml at 15 days storage and 33.00 mg/100 ml at 30 days of storage.

4.4.7.4. MAP of passion fruit in ambient storage condition

The interactive results regarding the effect of different treatments in ambient condition have been shown in Table 4.20. The lower value of ascorbic acid was found in T19 (23.91 mg/100 ml) followed by T18 (24.33 mg/100 ml). On the other hand, the fruits kept in bags with more number of perforations were discarded after the 5th day of analysis due to its reduction in consumer's appeal.

Table 4.19 Change in ascorbic acid of commercial wax coated fruits

Treatments	Storage period (weeks)				Mean
	1	2	3	4	
T13	38.59 ^f	34.99 ^f	30.40 ^f	24.40 ^f	32.09
T14	34.58 ^d	29.99 ^d	27.50 ^d	23.38 ^d	28.86
T15	33.38 ^c	28.50 ^c	27.00 ^c	22.89 ^c	27.94
T16	36.14 ^e	34.26 ^e	28.99 ^e	23.91 ^e	30.82
T17	34.57 ^d	30.00 ^d	27.49 ^d	23.91 ^e	28.99
T18	30.59 ^b	27.51 ^b	24.99 ^b	21.90 ^b	26.25
T19	30.17 ^a	26.50 ^a	22.01 ^a	20.39 ^a	24.77
T20	42.57 ^g	40.51 ^g	32.00 ^g	24.91 ^g	35.00
Mean	34.00	30.25	26.91	22.97	

4.4.8 Firmness

As the fruit ripens the flesh becomes softer. At the peak of ripening the fruit firmness of fruit decreases and softening of the fruit is associated with an increased solubility of cell wall pectins.

The results regarding the effect of different treatments on firmness have been shown in Appendix VII. The statistical results indicated that the fruits showed significant variation ($P < 0.05$) in the firmness during storage.

4.4.8.1. Change in firmness of bee wax coated fruits under MAP

Data in Fig. 4.27 indicated that a gradual decrease in firmness occurred towards the end of the storage period. Fruits in T6 (bee wax + LDPE 200 without perforation) recorded the highest significant value of firmness (60.84 N). This was due to the retardation in ripening of fruits because of the combined barrier properties of both wax and LDPE bags (Mota *et al.*, 2003; Hagenmaier, 2000). The decrease in trend was indicated by, Firmness = $-4.45x + 78.5$ ($R^2 = 0.9968$), where x is the storage period (weeks). However, the lowest value of firmness (47.73 N) was noted in T0 (only bee wax).

Table 4.20 Change in ascorbic acid content of fruits kept in ambient storage

Treatments	Days of storage	
	5	10
T0	37.93 ^o	-
T1	35.14 ⁱ	34.08 ⁱ
T2	34.94 ^h	33.92 ^g
T3	36.28 ⁿ	-
T4	34.88 ^g	-
T5	35.14 ⁱ	34.01 ⁱ
T6	34.15 ^f	33.09 ^c
T7	35.51 ^j	-
T8	35.94 ^l	33.97 ^h
T9	35.71 ^k	-
T10	35.16 ⁱ	-
T11	35.73 ^k	33.76 ⁱ
T12	36.16 ^m	34.19 ^j
T13	35.95 ^l	-
T14	31.94 ^d	28.32 ^d
T15	30.74 ^c	27.12 ^c
T16	33.50 ^e	-
T17	31.93 ^d	-
T18	27.95 ^b	24.33 ^b
T19	27.53 ^a	23.91 ^a
T20	39.94 ^p	-

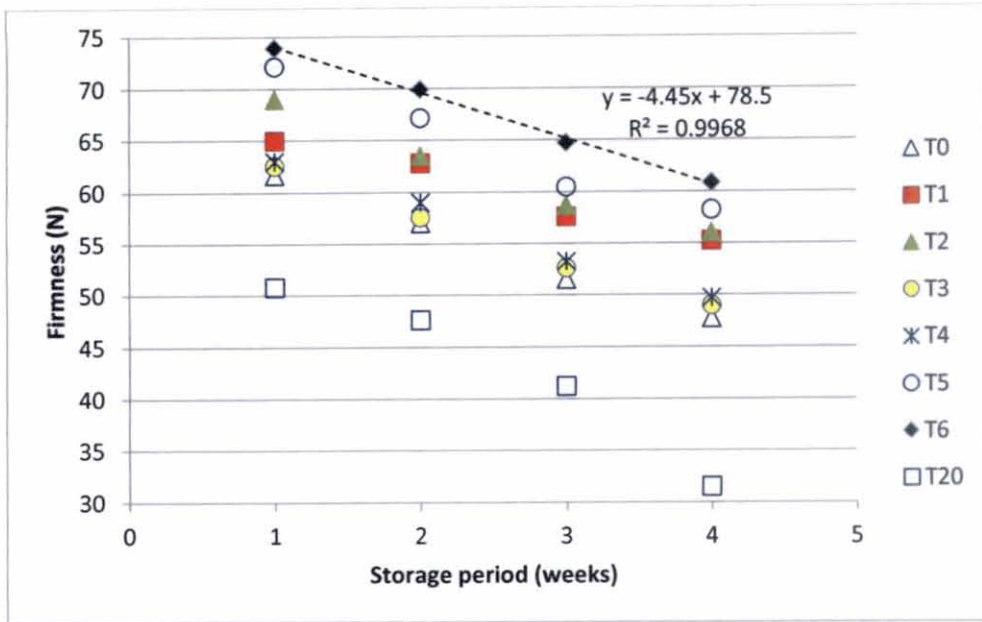

Fig. 4.18 Change in firmness of bee wax coated fruits

4.4.8.2. Change in firmness of uncoated fruits under MAP

The results pertaining to firmness of MAP passion fruits showed that different sets of perforation affected the firmness. There were consistently significant differences in firmness between T12 (LDPE 200 without perforation) (57.87 N) and their equivalent control fruit (31.51 N). The mean firmness of T12 was also found to be more (63.94 N). This was due to the absence of gaseous exchange in T12. Reduced rate of firmness as a result of MA have been reported by Golding *et al.*, (2005). The mean value of firmness was found to be decrease from 62.03 to a minimum of 45.37.

4.4.8.3. Change in firmness of commercial wax coated fruits under MAP

Fig. 4.18 shows that there was a drastic reduction in firmness of commercial wax coated fruits. The maximum firmness (69.32 N) was observed in T19 (commercial wax + LDPE 200 gauge without perforation). The maximum firmness may be due to the creation of MAP by both wax and LDPE bags. This study was in line with observations made by Hagenmaier (2000) and Rojas *et al.*, (2002), who reported that firmness and strength of citrus improved when fruit was

coated, while uncoated fruits turn soft upon storage. The trend was decreasing with the equation,

$$\text{Firmness} = -6.3x + 94.22 \quad (R^2 = 0.9878), \quad \text{-----4.6}$$

where x is storage period (weeks).

Table 4.21 Change in firmness of uncoated fruits

Treatments	Storage period (weeks)				Mean
	1	2	3	4	
T7	54.38 ^t	48.38 ^t	41.38 ^t	36.68 ^t	45.21
T8	61.39 ^d	58.39 ^d	55.09 ^d	43.59 ^d	54.62
T9	65.38 ^b	63.38 ^b	59.38 ^b	47.48 ^b	58.91
T10	54.79 ^e	53.19 ^e	52.29 ^e	41.59 ^e	50.46
T11	63.80 ^c	58.50 ^c	55.20 ^c	45.00 ^c	55.62
T12	72.47 ^a	65.27 ^a	60.17 ^a	57.87 ^a	63.94
T20	50.81 ^g	47.61 ^g	41.21 ^g	31.51 ^g	42.78
Mean	62.03	57.85	53.92	45.37	

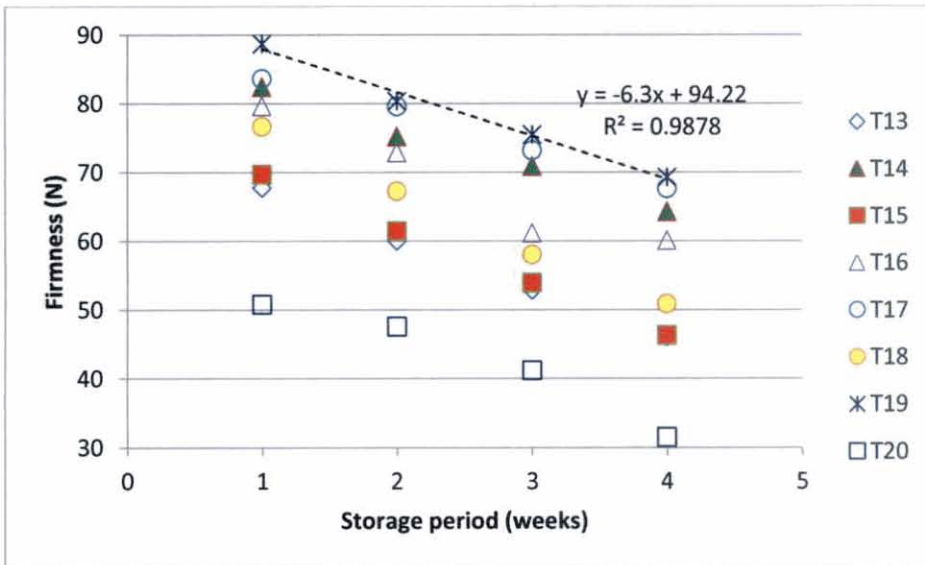

Fig. 4.19 Change in firmness of commercial wax fruits

4.4.8.4. MAP of passion fruit in ambient storage condition

The results in table 4.22 showed the higher firmness of 81.69 N was recorded in T19, while lower firmness of 53.36 N was observed in T8 after the 10th day of analysis. This was also due to the combined action of coating and plastic bags (Randhawa *et al.*, 2009). However, the fruits kept in bags with more number of perforation lost its consumer's appeal immediately, after the 5th day of analysis and hence they were discarded.

4.4.9. Gas analysis

4.4.9.1. MAP of fruits in cold storage

The percentage of O₂ and CO₂ present in the non-perforated bags were showed in Table 4.23 and 4.24. The mean of both tables (4.23 & 4.24) clearly shows that O₂ decreases and CO₂ increases from a 9.33% to 2.54% and from 4.61% to 7.9% respectively, during the entire storage period. Among the treatments, T19 (commercial wax coated) has the minimum

Table 4.22 Change in firmness of fruits kept in ambient storage

Treatments	Days of storage	
	5	10
T0	58.09 ^o	-
T1	61.43 ^k	57.97 ⁱ
T2	65.42 ⁱ	61.96 ^h
T3	58.95 ⁿ	-
T4	59.43 ^m	-
T5	68.57 ^g	65.11 ^t
T6	70.38 ^t	66.92 ^e
T7	50.81 ^p	-
T8	57.82 ^o	53.36 ^k
T9	61.81 ^k	-
T10	51.22 ^p	-
T11	60.23 ^l	55.77 ^j
T12	68.90 ^c	64.44 ^c
T13	64.24 ^l	-
T14	78.82 ^c	75.36 ^b
T15	66.17 ^h	62.72 ^g
T16	76.03 ^d	-
T17	80.02 ^b	-
T18	73.08 ^e	69.62 ^d
T19	85.15 ^a	81.69 ^a
T20	47.24 ^q	-

percentage of both CO₂ (4.1%) and O₂ (0.98%) when compared to that of T6 (bee wax coated). This may be due to the commercial wax coating which acts as a barrier against respiration, thus controlling the respiration rate (Dou, 2009).

In T12 (without coating), the percentage of both CO₂ (12.3%) and O₂ (3.66%) was found to be maximum, confirming the results of Gonzalez *et al.*, (1990), who wrapped 'Keitt' mangoes in LDPE film. This may be due to the metabolic activity of the fruits, as these fruits lacked surface coatings. This result corresponds to that of Singh *et al.*, (1998) who found MA storage to be effective in controlling the rate of metabolic activities.

Table 4.23 Depletion of O₂ (%) in MAP of passion fruits

Treatments	Storage period (weeks)				Mean
	1	2	3	4	
T6	10.66 ^b	7.30 ^b	4.66 ^b	2.98 ^b	6.40
T12	15.20 ^c	10.40 ^c	6.13 ^c	3.66 ^c	8.85
T19	2.13 ^a	2.10 ^a	1.72 ^a	0.98 ^a	1.73
Mean	9.33	6.60	4.17	2.54	

Table 4.24 Enrichment of CO₂ (%) in MAP of passion fruits

Treatments	Storage period (weeks)				Mean
	1	2	3	4	
T6	5.80 ^b	6.70 ^b	7.20 ^b	7.30 ^b	6.75
T12	6.70 ^c	7.60 ^c	10.70 ^c	12.30 ^c	9.32
T19	1.35 ^a	2.80 ^a	3.60 ^a	4.10 ^a	2.96
Mean	4.61	5.70	7.16	7.9	

4.4.9.2. MAP of fruits in ambient condition

The result of gas analysis done in fruits kept in ambient condition is presented in Table 4.25. The composition of O₂ (%) decreases and CO₂ (%) increases which was similar as in the case of fruits kept in cold storage conditions. The the rate of decrease and increase was comparatively more. The changes in

internal gas composition were due to the modification of the natural permeability of the fruit skin caused by coating (Rodov *et al.*, 2002).

Table 4.25 Gas composition of fruits kept in ambient condition

Treatments	Days of storage			
	O ₂ (%)		CO ₂ (%)	
	5	10	5	10
T6	11.73 ^b	9.48 ^b	6.50 ^b	7.42 ^b
T12	14.70 ^c	10.21 ^c	7.63 ^c	9.74 ^c
T19	3.64 ^a	2.97 ^a	3.01 ^a	4.65 ^a

4.4.10. Appearance

The external appearance of the fruits declined linearly with storage time. This may be due to the loss of moisture, which in turn affected the quality of fruits. However, shrivelling was less at T6, T19 and T12, as previously reported for purple passion fruit (Pruthi, 1963). Water loss may have contributed to the higher rates of fruit deterioration in T20 (control). T6, T19 and T12 showed better results as compared to the other treatments without any shrivelling even after 30 days of storage. The bee wax and commercial wax coated fruits were greenish even after 30 days of storage. This may be due to the delayed ripening process of coating. At the same time, the fruits in T12 ripened as the fruits were not treated with coatings.

In the first week of analysis, there was no change in appearance of fruits. In the second week, the fruits packed in perforated bags started shrivelling. In the third week of storage, the fruits that were packed in bags without coating shrivelled more which lost the consumer's appeal. This shrivelling may be due to the loss of moisture (Arjona *et al.*, 1994). The shrivelling was also found in the fruits that were coated but not packed in bag. After the fourth week of storage, the fruits in all the treatments were shrivelled and the fruits coated with bee wax were attacked by fungus.



Plate 4.6 Fruits after fourth week of storage

Plate 4.6 shows the appearance of fruits after the fourth week of experimentation.

Summary & Conclusions

CHAPTER V

SUMMARY AND CONCLUSION

Passion fruit (*Passiflora edulis*), a tropical fruit species has become a popular supplement to some diets and are especially used for juice processing, which is often added to other fruit juices to enhance aroma. The fruit is highly perishable which losses its moisture immediately after the second day of harvest and affects the consumer's appeal. Surface coating with wax enhances the shelf life of passion fruit by reducing its PLW and also by retarding ripening. The objective of the present study was to develop a wax applicator and to evaluate the post harvest behaviour of passion fruit during modified atmosphere packed fruits during storage by measuring the quality parameters.

The properties of the fruits like sphericity, surface area and angle of repose were determined for designing the wax coating machine. The major components of the wax applicator included a 12 V motor, a stainless steel tank having a capacity of 5 litres, a pump, a sprayer, two perforated rollers and four flexible bristle roller brushes. The wax stored in the bottom tank was pumped and sprayed from above through a pipe having numerous holes of diameter 0.5 mm. The brushes which rotate @ 100 rpm would be saturated with wax and spin the product, smearing the wax evenly over the product surface. This ensured a uniform and complete impervious coating to each fruit in a continuously moving stream of fruits. The machine was found to be simple, economic and efficient in design. The capacity of the applicator was 250 kg/hr. The consumption of wax and its application time was significantly less. However, the coating efficiency was high without any mechanical damage. After waxing, the fruits were air dried using a blower.

The effects of MAP and edible natural wax (bee wax) and commercial wax coating on extending the shelf life of yellow passion fruits were studied under cold (7°C and 90% RH) and ambient conditions (32 - 35°C, 70 - 80% RH) and were standardised. The bee wax was emulsified with rice bran oil and standardised in the ratio of 1:100. In addition, commercial wax coating was used

at dilution in water. Twenty one samples with three replications each were prepared based on treatment of wax coating (bee wax and commercial wax), perforated LDPE bags of 200 and 400 gauge (0%, 0.5%, 1% and 2% levels of perforations) and their combination for use on fruits for the purpose of study under cold and ambient conditions. Their initial weight, TSS, acidity, ascorbic acid, moisture content of pulp and peel were noted.

The postharvest behaviour of the fruits kept in all the treatments were evaluated in an interval of 7 and 5 days for fruits kept in cold storage and in ambient conditions respectively. The results obtained for different parameters are summarized below.

Among all the treatments, wax coating in combination with the use of non-perforated LDPE 200 gauge bags were found to be effective. The passion fruits coated with bee wax and commercial wax showed minimum PLW of 0.23% and 0.63% respectively when compared to that of uncoated fruits (1.82%). The fruits kept as control exhibited higher PLW of 27.07%.

The chemical characteristics i.e., TSS, acidity and ascorbic acid were significantly affected by different treatments. The passion fruits coated with commercial wax and bee wax showed lower TSS concentration of 14.4° Brix and 15.1° Brix respectively. The higher TSS concentration was found in control (19.4° Brix).

The results revealed that maximum acidity (6.4%) was recorded in bee wax coated fruits when compared to that of commercial wax coated fruits (5.4%). The minimum acidity was recorded in control (4%).

The ascorbic acid content of passion fruits varied significantly with respect to the different treatments and their interactions. The ascorbic acid content of bee wax coated fruits were found to be lower (18.89 mg/100 ml) when compared to that of commercial wax coated fruits (20.39 mg/100 ml). The highest ascorbic acid content was recorded in fruits that were kept as control.

After 30 days of storage, noticeable changes in skin colour occurred. Passion fruits coated with bee wax was darker (lower 'L' value), slightly green (lower 'a' value) and less yellow (lower 'b' value) when compared to that of control.

The maximum pulp moisture content was observed in bee wax coated fruits with LDPE (without perforation) (71.52%) when compared to that of control (60.81%). There was only a slight variation of peel moisture content during the entire period of storage and it was found to be higher in the case of bee wax coated fruits with LDPE (without perforation) (85.98%).

The commercial wax coated fruits were found to be firm when compared to that of bee wax coated fruits. After the 30 days of storage, the fruits kept without coating became softer, due to ripening.

The concentration of O₂ and CO₂ was found to be lower in the case of commercial wax coated fruits when compared to that of bee wax coated fruits. Regarding the appearance, the fruits coated with bee wax and commercial wax were remaining as such as it was found at the time of harvest. The fruits kept as control shrivelled and it lost the consumer's appeal.

The samples kept as control did not last longer than 15 days whereas the wax coated fruits store for a period of 40 days at cold condition. However the quality analysis were done only up to 28 days as the fruits kept under perforated LDPE bags also lost their commercial value after 4 weeks of storage. In the case of ambient condition, the coated fruits had a shelf life of 10 days. However, the fruits kept under control could not store beyond two days.

Observing the results of various analysis conducted, it was concluded that the sample of fruits coated with bee wax and commercial wax coated fruits kept in LDPE 200 gauge bags without perforation proved to be the best in terms of physiochemical characteristics. But some traces of fungal growth was obtained in the case of bee wax coated fruits and so commercial wax coated fruits were found to be effective in increasing the shelf life of passion fruits.

Thus by modifying the respiration rate, the coating delayed the ripening process, thereby extending the shelf life and maintaining the quality of the fruits. The retardation of the ripening process in the present study may be due to the modified atmosphere. Surface coating has been reported to increase resistance of fruit skin to gas permeability, creating a modified internal atmosphere and reducing the respiration rate.

References

References

- Aharoni, N. 2004. *Packaging of Fruits and Vegetables* [Power Point Lecture Slides]. International Research & Development course on Postharvest Biology & Technology. The Volcani Center, Israel.
- Akamine, E.K., Beaumont, J.H., Bowers, F.A.I., Hamilton, R.A., Nishida, T., Sherman, G.D., Shoji, K. and Storey, W.B. 1957. *Passion fruit culture in Hawaii*. Univ. of Hawaii Ext. Circ. No. 345, Hawaii. 35p.
- Akamine, E.K., Young, R.E. and Biale, J.B. 1956. Respiration and ethylene production in the purple passion fruit. *Proc. Am. Soc. Hort. Sci.* 69: 221-225.
- Akath, S., Yadav, D.S., Patel, P.K. and Mousumi, B. 2007. Effect on shelf-life and quality of passion fruit with polyethylene packaging under specific temperature. *J. Fd. Sci. Technol.* 44(2): 201-204.
- Alam, M.D.S. and Paul, S. 2001. Efficacy of casein coating on storage behaviour of kinnow. *J. Fd. Sci. Technol.* 38(3): 235-238.
- Alfiya, N., Ashly, K.R. and Sangeetha, P.S. 2010. Modified atmosphere packaging on shelf life extension of passion fruit. B.Tech (Ag. Engng.) thesis, Kerala Agricultural University, Thrissur, 19p.
- [Anonymous]. 2004. *Waxing fruits and vegetables*. Postharvest handling Tech. Bull. No: 33, Natl. Agric. Res. Ins, Georgetown. pp. 2-9.
- [Anonymous]. 2008. TNAU Agritech Portal [on line]. Postharvest technology: Introduction. Available: <http://www.agritech.tnau.ac.in/postharvest/postharvest.htm>
- [Anonymous]. 2011.[on line]. Available <http://www.indolinkenglish.wordpress.com/category/did-you-know-that/html>.
- AOAC. 2000. *Official Methods of Analysis*, Am. Ass. Analyt. Chem., 15th ed. Arlington, USA. 21-447.
- Aquino, S.D., Molinu, M.G., Piga, A. and Agabbio, M. 2001. Influence of film wrapping on quality maintenance of Salustiana oranges under shelf life conditions. *Ital. J. Fd. Sci.* 13: 87.
- Aquino, S.D. and Palma, A. 2003. Quality of film wrapped *Miyagawa satsumas* stored at 20-22⁰C. *Ital. J. Fd. Sci.* 4(15): 553-567.

- Arjona, H.E. and Matta, F.B. 1991. Postharvest quality of passion fruit as influenced by harvest time and ethylene treatment. *Hort. Sci.* 26: 1297-1298.
- Arjona, H.E., Matta, F.B. and Garner, J.O. 1992. Temperature and storage time affect quality of yellow passion fruit. *Hort. Sci.* 27: 809-810.
- Arjona, H.E. 1990. Postharvest physiology studies of passion fruit (*Passiflora edulis Sims*). Ph.D. thesis, Mississippi State Univ., Mississippi, 1-100.
- Arjona, H.E., Matta, F.B. and Garner, J.O. 1994. Wrapping in polyvinyl chloride film slows quality loss of yellow passion fruit. *Hort. Sci.* 29(4): 295-296.
- Bajwa, B.E. and Anjum, F.M. 2007. Improving storage performance of *Citrus reticulata* Blanco mandarins by controlling some physiological disorders. *Int. J. Fd. Sci. Technol.* 42: 459-501.
- Banks, N., Dadzie, B. and Cleland, D. 1993. Reducing gas exchange of fruit with surface coating. *Postharvest Biol. Technol.* 3: 269-284.
- Banks, N.H., Cutting, J.G.M. and Nicholson, S.E. 1997. Approaches to optimising surface coatings for fruits. *N.Z. J. Crop Hort. Sci.* 25: 261-272.
- Bender, R.J., Brecht, J.K., Sargent, S.A. and Huber, D.J. 2000. Low temperature controlled atmosphere storage for tree-ripe mangoes (*Mangifera indica* L.). *Acta Hort.* 509: 458-447.
- Beninca, J.P., Montanher, A.A., Zucolotto, S.M., Schenkel, E.P. and Frode, T.S. 2007. Evaluation of the anti-inflammatory efficacy of *Passiflora edulis*. *Fd. Chem.* 104: 1097-1105.
- Biale, J.B. 1975. Synthetic and degradative process in fruit ripening. In: Haard, D.K. and Salunkhe, N.F. (ed.), *Postharvest biology and handling of fruits and vegetables*, Westport, Conn.: AVI, 5-18.
- Campbell, C.W. and Knight, R.J. Jr. 1983. Produccion de granadilla. *Comunicacion XIII Congress NORCOFEL*. Canary Islands, Spain: Ministerio de Agricultura. 223-231.
- Cantwell, M. 2001. Properties and recommended conditions for long-term storage of fresh fruits and vegetables.(unpublished) 1-8.
- Cereda, M.P., Brasil, M.A.M. and Lima, U.A. 1976. Conservacao do maracuja amarelo para consumo "in natura". *Acta Hort.* (57): 145-50.

- Chan, H.T. 1980. Passion Fruit. In *Tropical Fruits - composition, properties and uses*, by S. and Shaw, P.E. Nagy, 300-315.
- Chan, H.T., Jagtiani, J. and Sakai, W.S. 1988. Tropical Fruit Processing. *Fd. Sci. Technol.*, 149-180.
- Claypool, L.L. 1939. The waxing of deciduous fruits. *Proc. Am. Soc. Hort. Sci.* 37: 443-447.
- C.S.I.R.O., Australia. 1934. Storage of Passion fruit. Division of Food Preservation, 8th Ann. Report, p 55. In Pruthi, J.S. 1963. Physiology, chemistry & technology of passion fruit. *Adv. Fd. Res.* 12: 55.
- D' Aquino, S., Piga, A., Agabbio, M. and McCollum, T.G. 1998. Film wrapping delays ageing of "Minneola" tangeols under shelf-life conditions. *Postharvest Biol. Technol.* 14(1): 107-116.
- De-Ketelaere, B., Howarth, M.S., Crezea, L., Lammertyn, J., Viaene, K., Bulens, I. and De-Baerdamdakes, J. 2006. Postharvest firmness changes as measured by acoustic and low-mass impact devices: a comparison of techniques. *Postharvest Biol. Technol.* 41: 275-284.
- Ding, C.K., Chachin, K., Ueda, Y., Imahori, Y. and Wang, C.Y. 2002. Modified atmosphere packaging maintains postharvest quality of loquat fruit. *Postharvest Biol. Technol.* 24(3): 341-48.
- Dou, H., Ismail, M.A. and Petracek, P.D. 1999. Reduction of post harvest pitting of citrus by changing wax components and their concentrations. *Proc. FL Stat Hort. Soc.* 112: 159-63.
- Echeverria, G.V., Canumir, J.V. and Serri, H.G. 2009. Postharvest behaviour of highbush blueberry fruits cv. O'Neal cultivated with different organic fertilization treatments. *Chilean J. Agric. Res.* 69(3): 391-399.
- El-Anany, A.M., Hassan, G.F.A. and Rehab Ali, F.B. 2009. Effects of edible coatings on the shelf life and quality of Anna apple (*Malus domestica* Borkh) during cold storage. *J. Fd. Technol.* 7(1): 5-11.
- Fallik, E and Aharoni, Y. 2004. *Postharvest physiology, pathology and handling of fresh produce*. The Volcani Centre, 30p.
- Fitzgerald, J.R. 1958, Feb.4. Wax applicator for fruits, vegetables and the like. U.S. Patent 2821957.

- Fonesca, S.C., Oliveira, F.A.R., Lina, I.B.M., Brecht, J. and Chau, K.V. 2000. Modelling O₂ and CO₂ exchange for development of perforation-mediated modified atmosphere packaging. *J. Fd. Engng.* 43: 9-15.
- Gillespie, K. 1980. *Citrus waxing*. Packingshed Newsletter No: 3. Dept. of Agric. South Australia. pp. 1-4.
- Golding, J.B., Sophr, L., Newman, S., Tanner, D.J., Orszulo, E., Smale, N., Graves, C. and McGlasson, W.B. 2005. Non-destructive assessment of peach and nectarine firmness. *Acta Horticulturae* 687: 261-269.
- Gonzalez, G., Elhadi, M.Y. and Higuera, I. 1990. Modified atmosphere packaging of mango and avocado fruit. *Acta Horticulturae* 269p.
- Hagenmaier, R. 2000. Evaluation of polyethylene candelilla coatings for Valencia oranges. *Postharvest Biol. Technol.* 19: 147-154.
- Hagenmaier, R.D. 2002. The flavor of mandarin hybrids with different coatings. *J. Agric. Fd. Sci.* 41: 283-87.
- Hahn, F. 2004. Mango firmness sorter. *Biosystems Engng.* 89: 309-19.
- Hailu, M., Workneh, T.S. and Belew, D. 2011, Dec. Effect of packaging material on the quality of banana cultivars. *Afr. J. Agric. Res.* 7(7): 1226-1237.
- Hall, E.G. 1958. *Handling and storing fresh fruit and vegetables in the home*. pp. 61-62.
- Harmond, J.E., Brandenbug, N.R. and Jensen, L.A. 1965. Physical properties of seeds, Trans. *ASAE* 8(1): 30-32.
- Hatem, M.H., Mohsen, S.M. and El-Nasr, W. 2005. Physical and Engng. characteristic, and oil extraction for some olive fruits varieties. *J. Agric. Engng.* 22(2): 498-512.
- Hayat, I. Masud, T. and Rathore, H.A. 2003. Effect of coating and wrapping materials on the shelf life of apple. *Int. J. Fd. Safety.* 5: 24-34.
- Heal, C. and Allsop, M. 1986. *Queer Gear*. Century Hutchinson, London.
- Huelin, F.E. 1962. *Personal Communication* In Pruthi, J.S. 1963. Physiology, chemistry and technology of passion fruit. *Adv. Fd. Res.*, 12: 221.
- Ibrahim, M.A. 1992. Design an apparatus suitable for winnowing and separating wheat products from stationery threshers. M.Sc. Thesis, Fac. of Agric., Alexandria Univ..

- Illeperuma, C.K. and Jayasuriya, P. 2002. Prolonged storage of 'Karuthacolomban' mango by modified atmosphere packaging at low temperature. *J. Hort. Sci. Biotech.* 77(2): 153-57.
- Irtwange, S.V. 2006, Feb. Application of modified atmosphere packaging and related technology in postharvest handling of fresh fruits and vegetables. *Agric. Engng. Int.* 8(4): 1-12.
- ITC (International Trade Centre) Newsletter. 1989. *Personal Communication* with Henry, J., Senior Marketing Adviser, ITC, Geneva.
- Jobling, Jenny. 2001. Modified atmosphere packaging: Not as simple as it seems. *Good Fruit Vegetable Mag.* 11(5): 1-3.
- Joy, P.P. 2010. Status and prospects of passion fruit cultivation in Kerala [online]. Available : <http://www.kau.edu/prsvkm/html>. [1 January 2012]
- Kader, A.A. 1986. Biochemical and physiological basic for effects of controlled and modified atmosphere on fruit and vegetables. *Fd.Technol.* 40(5): 99-104.
- Kader, A.A., Cantwell, M. and Mitchell, F.G. 1986. *Gas diffusion, water loss and quality of pears and stone fruits as affected by "Semperfresh" coating.* Progress Report, Dept. of Pomology, Univ. of California, USA: Davis.
- Kaleem, F.H., Ismail, Z.E. and Abdel Hakim, G.R. 1993. Factors affecting grain cleaning efficiency. Part 1: Grain straw mixture and characteristics. *J. Agric. Engng.* 10(2): 369-382.
- Kaushal, B.B.L. and Thakur, K.S. 1996. Influence of ambient and evaporative cool chamber storage conditions on the quality of polyethylene packed Kinnow. *Adv. Hort. Sci.* 10: 179-184.
- Kays, S.J. and Paull, R.E. 2004. Secondary metabolic processes and products. *Postharvest Biol.* 137-232.
- Kefford, J.F. 1954. Chemistry and technology of fruit and vegetable juice production. In: Chan, H.T., Jagtiani, J. and Sakai.W.S. 1988. *Tropical fruit processing, Fd. Sci. Technol.* A series of monographs, pp. 53-57.
- Knight, R.J. and Sauls, J.W. 1983. *The passion fruit.* Fruit Crop Fact Sheet FC-60, Gainesville: Florida Coop. Ext. Serv..pp.1-5.
- Kore, V.T. and Kabir, J. 2012. Influence of waxing and polyethylene packaging on shelf life of Guava. *Crop Res.* 41: 98-102.

- Krochta, J.M. 1997. Edible composite moisture barrier films. In *Packaging Yb.*, by B. Blakiston, Wash. D.C.. 38p.
- Kundan, K., Pathak, K.A. and Shukla, R. 2009, Feb. Sequential development of reproductive organs in yellow passion fruit (*Passiflora edulis*). *Indian J. Agric. Sci.* 79(2): 141-144.
- Kundan, K., Pathak, K.A., Shukla, R. and Bharali, R. 2011. Effect of storage temperature on physico-chemical and sensory attributes of purple passion fruit (*Passiflora eulis Sims*). *J. Fd. Sci. Technol.* 48(4): 484-488.
- Ladaniya, M.S. 2001. Response of 'Mosambi' sweet orange (*Citrus sinensis*) to degreening, mechanical waxing, packaging & ambient storage conditions. *Indian J. Agric. Sci.* 71(4): 234-239.
- Ladaniya, M.S. 2004. Standardization of temperature for long term refrigerated storage of mosambi sweet orange. *J. Fd. Sci. Technol.* 41(6): 692-696.
- Mahajan, B.V.C., Dhatt, A.S. and Sandhu, K.S. 2005. Effect of different postharvest treatments on the storage life of kinnows. *J. Fd. Sci. Technol.* 42(4): 269-299.
- Marupadi, S.L., Abirami, L.S.S., Pushkala, R. and Srividya, N. 2011. Enhancement of storage life and quality maintenance of papaya fruits using aloe vera based antimicrobial coating. *Indian J. Biotech.* 10: 83-89.
- Matta, F.B., Arjona, H.E., Garner, J.O. and Silva, J.L. 2006, Oct. *Studies on postharvest quality of passion fruit*. Mississippi Agric. and Forestry Experiment Stn., Mississippi. pp.1-9.
- Matuska, M. Lenart, A. and Lazarides, H.N. 2006. On the use of edible coatings to monitor osmotic dehydration kinetics for minimal solids uptake. *J. Fd. Engng.* 72: 85-91.
- McGregor, B.M. 1987. *Tropica products transport handbook*. U.S.: Dept. Agr. Hdbk.668p.
- McGuire, R.G. 1992. Reporting of object colour measurements. *Hort. Sci.* 27: 1254-1255.
- McGuire, R.G. and Hullman, G.U. 1995. Coating guavas with cellulose or carnauba-based emulsions interferes with postharvest ripening. *Hort Sci.* 30: 294-295.

- Meir, S., Naiman, D., Hyman, J.Y., Akerman, M., Zauberman, G. and Fuchs, Y. 1998. Modified atmosphere packaging enables prolonged storage of 'Fuerte' avocado fruit. *Acta Hort.* 464: 397-402.
- Mir, N. and Beaudry, R.M. 2000. Modified atmosphere packaging. Michigan State Univ. Michigan. pp. 293-303.
- Mohsenin, N.N. 1970. *Physical properties of plant and animal material*. N.Y.: Gordon and Breach Sc. Publ..889p.
- Moleyar, V. and Narasimham, P. 1994. Modified atmosphere packaging of vegetables: An appraisal. *J. Fd. Sci. Technol.* 31: 267-278.
- Mollenhauer, H.P. 1954. The passion fruit. *Fd.. Manufacturer.* 29:149. In Pruthi, J.S. 1963. Physiology, chemistry, & technology of passion fruit. *Adv. Fd. Res.* 12: 203-282.
- Montanher, A.B., Socolotto, S.M., Schenkel, E.P. and Frode, T.S. 2007. Evidence of anti-inflammatory effects of *Passiflora edulis* in an inflammation model. *J. Eth-nopharmacol.* 109: 281-288.
- Mota, W.S.S., Salomao, L.C.C., Cecon, P.R. and Fernando, L.F. 2003. Waxes and plastic film in relation to the shelf life of yellow passion fruit. *Scientia Agricola.* 60(1): 51-57.
- Nanda, S. Sudhakar Rao, D.V. and Krishnamurthy, S. 2001. Effects of shrink film wrapping and storage temperature on the shelf life and quality of pomegranate fruits. *Postharvest Biol. Technol.* 22: 61-69.
- Nyambati, M.G. 1984. The effect of permeable coatings on the storage of fruit. Prolong treatment on purple passion fruit *Passiflora edulis*. Sims. (unpublished).
- Owalarafe, O.K. and Shotonde, H.O. 2004. Some physical properties of fresh Okra fruit. *J. Fd. Engng.* 63(3): 299-302.
- Pal, R.K., Susanta, R.K. and Sanjay, S. 1997. Storage performance of kinnow mandarins in evaporative cool chamber and ambient conditions. *J. Fd. Sci. Technol.* 34(3): 200-203.
- Pantastico, Er. B., Chattopadhyaya, T.K. and Subramanyam, H. 1975. Storage and commercial storage operation. In *Postharvest Physiology, handling and utilization of tropical and sub-tropical fruits and vegetables*. AVI Publishing Company. 560p.

- Pappas, G., Skinner, G.E. and Rao, N.M. 1988. Effect of imposed strain and moisture content on some viscoelastic characteristics of cowpeas. *J. Agric. Engng. Res.* 39(3): 290-219.
- Perez, M.B., Rojas, C. and Del-Rio, M.A. 2002. Effect of lipid type and amount of edible hydroxyl propyl methylcellulose lipid composite coatings used to protect postharvest quality of mandarins. *J. Fd. Sci.* 67(8): 2903-2910.
- Perez, M.B., Rojas, C. and Del-Rio, M.A. 2003. Effect of hhydroxypropy methylcellulose lipid edible composite coatings on plum quality during storage. *J. Fd. Sci.* 68(3): 879-883.
- Petracek, P.D., Dou, H. and Pao, S. 1998. The influence of applied waxes on post harvest physiological behaviour and pitting of grapefruit. *Postharvest Biol. Technol.* 14: 99-106.
- Pruthi, J.S. and Lal, G. 1955. Some technical aspects of manufacture of passion fruit squash. *Chem. Age (India)* 6(2): 39.
- Pruthi, J.S. 1963. *Physiology, chemistry and technology of passion fruit*. Vol. 12, in *Adv. Fd. Res.*, by C.O., Mark, E.M. and Stewart, G.F. Chichester, N.Y.: Academic. 203-282.
- Pulamte, L. 2008. Key issues in post harvet management of fruits and vegetables in India. *Sci. Technol.* 328-39.
- Purseglove, J.W. 1980. *Tropical Crops: Dicotyledons*. II. London: Longmans. 420-426.
- Raghav, P.K. and Gupta, A.K. 2000. Quality and shelf life of individually shrunked wrapped Kinnow fruit. *J. Fd. Sci. Technol.* 37(6): 613-616.
- Raghavan, G.S.V. and Gariepy, Y. 1985. Structure and instrumentation aspects of storage systems. *Acta Horticulturae* 157: 5-30.
- Raghavan, G.S.V., Gariepy, Y. and Vigneault, C. 2003. Controlled atmosphere storage. In *Encyclopedia of Agric. Fd. Biol. Engng.*, N.Y.: Marcel Dekker, Inc..148.
- Rajkumar, P., Viswanathan, R., Kailappan, R., Thirupathi, V. and Narayanan, L. 2007. Enhancing the shelf life of fully ripe guava and mango fruits using wax emulsions. *Agric. Mechanization in Asia, Afr. Latin Am.* 38(4): 55-60.

- Randhawa, J.S., Jawandha, S.K. and Gill, P.P.S. 2009. Effect of HDPE with edible oil and wax coating on storage quality of 'Kinnow' mandarin. *J. Fd.. Sci. Technol.* 46(2): 169-171.
- Rodov, V.B.H., Vinokur, Y., Copel, A., Aharoni, Y. and Aharoni, N. 2002. Modified atmosphere packaging improves keeping quality of Charentais-type melons. *Hort. Sci.* 37(6): 950-953.
- Rojas, C., Perez, M.B. and Del-Rio, M.A. 2002. Effect of lipid incorporation to locust bean gum edible coatings on Mandarin cv Fortune In: Zude, M., Herold, B. and Geyer, M. editors. *Proc. 6th Int. Symp. Fruit Nut and Vegetable Production Engineering* 11-14 September, 2000; Post Dam Germany. pp. 303-307.
- Sahay, K.M. and Singh, K.K. 1994. *Unit operations of Agric. Processing*. Vikas Publ. Home Pvt. Ltd. Bhopal. pp.7-13.
- Santana, L.G.R.R., Benedetti, B.C. and Monteiro, J.M. 2011. Maintaining quality of Douradao peaches for 28 days. In: *Int. Symp. on Towards a Sustainable Food Chain Food Process, Bioprocessing and Food Quality Management*; 18-20, April, 2011, Nantes, France. pp. 2-6.
- Ssemwanga, J.R.K. 1994. Promotion of fresh passion fruit trade through use of selected postharvest technologies. M.Sc. Thesis. Cranfield Inst. Technol. 1-66.
- Shellhammer, T.H. and Krochta, J.M. 1997. Whey protein emulsion film performance: Effect of lipid type and amount. *J. Fd. Sci.* 32: 390-394.
- Silva, L.J.B., De Souza, M.L., Neto, S.E.D. and Morais, A.P. 2009. Alternative covering in the shelf life conservation of yellow passion fruit produced in organic system. *Revista Brasileira De fruticultura.* 31(4): 995-1003.
- Silva, F.M., Chau, K.V., Brecht, J.K. and Sargent, S.A. 1999. Modified atmosphere packaging for mixed loads of horticultural commodities exposed to two postharvest temperatures. *Postharvest Biol. Technol.* 17: 1-9.
- Singh, B.P., Tandon, D.K. and Kalra, S.K. 1993. Changes in postharvest quality of mangoes affected by preharvest application of calcium salts. *Scientia Horti.* 54: 211-219.

- Singh, M., Panesar, P.S. and Marwaha, S.S. 1998. Studies on the suitability of Kinnow frutis for the production of wine. *J. Fd. Sci. Technol.* 35(5): 455-457.
- Souza, M. M., Palomini, G., Periera, T. N. S., Periera, M. G. and Viana, A. P. 2004. Flow symmetry analysis of genome size in some *Passiflora* species. *Hereditas* 141: 31-38.
- Thakur, K.S, Kaushal, B.B.L. and Sharma, R.M. 2002. Effect of different post harvest treatments and storage conditions on the fruit quality of Kinnow. *J. Fd. Sci.* 39(6): 609-618.
- Thirupathi, V., Sasikala, S. and Kennedy, J.Z. 2006. Preservation of fruits and vegetables by wax coating. In: *Sci. Tech. Entrepreneur* (Eds.Mittal, H.K. et al.) NSTEDB, DST. 1-10.
- Trout, S.A., Hall, E.G. and Sykes, S.M. 1953. Effects of skin coatings on the behaviour of apples in storage. I.Physiol. and Gen.Investigations.Austral. *J. Agric. Res.* 4: 57-81.
- Werkhoff, P., Gunnert, M., Krammer, G., Sommer, H. and Kaulen, J. 1998. Vacuum headspace method in aroma research: flavor chemistry of yellow passion fruit. *J. Agric. Fd. Chem.* 46: 1076-93.
- Wills, R.B.H., Lee, T.H., Graham, D., McGlasson, W.B. and Hall, E.G. 1982. *Postharvest. An introduction to the physiology and handling of fruit and vegetables.* New South Wales Univ. Press, Kensington, New South Wales, Australia. 39p.
- Wills, R., McGlasson, B., Graham, D. and Joyce, D. 1998. *Postharvest. An introduction to the physiology and handling of fruit, vegetables and ornamentals.* (4th Ed.) UNSW press. Sydney. 264p.
- Zagory, D. and Kader, A.A. 1988. Modified atmosphere packaging of fresh produce. *Fd. Technol.* 42(9): 70-77.

Appendices

Appendix I

a. Effect of bee wax coating on PLW of passion fruit

Treatments	Storage period (weeks)				Mean (%)
	1	2	3	4	
T0	1.99 ^f	5.72 ^g	8.86 ^g	11.14 ^g	6.93
T1	0.82 ^c	2.73 ^d	5.18 ^c	6.04 ^d	3.69
T2	0.66 ^b	1.78 ^b	5.38 ^d	4.42 ^b	3.06
T3	1.13 ^e	3.18 ^f	6.08 ^f	6.76 ^f	4.29
T4	1.00 ^d	3.05 ^e	5.47 ^e	6.36 ^e	3.97
T5	0.70 ^b	2.54 ^c	5.04 ^b	5.93 ^c	3.55
T6	0.17 ^a	0.18 ^a	0.21 ^a	0.34 ^a	0.23
T20	9.66 ^g	14.58 ^h	31.75 ^h	52.32 ^h	27.07
Mean (%)	2.02	4.22	8.5	11.66	

b. Effect of commercial wax coating on PLW of passion fruit

Treatments	Storage period (weeks)				Mean (%)
	1	2	3	4	
T13	4.26 ^g	12.67 ^g	20.68 ^g	28.20 ^g	16.45
T14	1.88 ^d	9.49 ^e	16.89 ^e	23.09 ^e	12.84
T15	1.59 ^c	6.27 ^c	10.49 ^c	16.17 ^c	8.63
T16	2.28 ^f	11.46 ^f	18.95 ^f	25.04 ^f	14.43
T17	1.98 ^e	7.22 ^d	12.61 ^d	19.90 ^d	10.43
T18	0.69 ^b	5.65 ^b	9.96 ^b	12.46 ^b	7.19
T19	0.19 ^a	0.54 ^a	0.78 ^a	0.99 ^a	0.63
T20	9.66 ^h	14.58 ^h	31.75 ^h	52.32 ^h	27.07
Mean (%)	2.82	8.48	15.26	22.27	

Appendix II

a. Change in TSS during storage of bee wax coated fruits

Treatments	Storage period (weeks)				Mean (° Brix)
	1	2	3	4	
T0	15.80 ^f	16.00 ^g	17.13 ^f	17.80 ^g	16.68
T1	15.00 ^d	15.50 ^e	16.20 ^d	17.00 ^e	15.92
T2	15.43 ^e	15.90 ^f	16.50 ^e	17.53 ^f	16.34
T3	14.77 ^c	15.00 ^e	16.00 ^e	16.20 ^e	15.49
T4	14.87 ^{cd}	15.40 ^d	16.07 ^c	16.400 ^d	15.68
T5	14.47 ^b	14.80 ^b	15.80 ^b	16.00 ^b	15.27
T6	13.97 ^a	14.17 ^a	14.50 ^a	15.07 ^a	14.49
T20	16.93 ^g	17.00 ^h	17.80 ^g	19.40 ^h	17.78
Mean (° Brix)	14.93	15.25	16.02	16.57	

b. Change in TSS during storage of commercial wax coated fruits

Treatments	Storage period (weeks)				Mean (° Brix)
	1	2	3	4	
T13	16.00 ^f	16.07 ^f	16.20 ^f	16.40 ^e	16.17
T14	15.37 ^d	15.60 ^d	15.80 ^d	16.07 ^d	15.71
T15	15.60 ^e	15.80 ^e	15.87 ^d	15.93 ^e	15.8
T16	15.70 ^e	16.00 ^f	16.10 ^e	16.40 ^e	16.05
T17	14.97 ^c	15.40 ^c	15.53 ^c	16.00 ^{cd}	15.48
T18	14.57 ^b	15.000 ^b	15.00 ^b	15.60 ^b	15.04
T19	13.77 ^a	14.07 ^a	14.00 ^a	14.40 ^a	14.06
T20	16.93 ^g	16.93 ^g	17.80 ^g	19.40 ^f	17.78
Mean (° Brix)	15.14	15.42	15.5	15.83	

Appendix III

a. Variation in acidity during storage of bee wax coated fruits

Treatments	Storage period (weeks)				Mean (%)
	1	2	3	4	
T0	6.58 ^g	6.26 ^g	5.07 ^g	5.05 ^g	5.74
T1	7.61 ^e	7.18 ^e	5.77 ^c	5.77 ^c	6.58
T2	7.86 ^b	7.25 ^b	5.94 ^b	5.87 ^b	6.72
T3	7.15 ^f	6.87 ^f	5.15 ^f	5.15 ^f	6.08
T4	7.34 ^d	6.94 ^e	5.30 ^e	5.29 ^e	6.22
T5	7.23 ^e	7.05 ^d	5.66 ^d	5.49 ^d	6.36
T6	7.99 ^a	7.54 ^a	6.51 ^a	6.40 ^a	7.12
T20	5.13 ^h	4.99 ^h	4.67 ^h	4.02 ^h	4.7
Mean (%)	7.39	7.01	5.63	5.57	

b. Variation in acidity during storage of commercial wax coated fruits

Treatments	Storage period (weeks)				Mean (%)
	1	2	3	4	
T13	5.25 ^f	5.00 ^f	4.72 ^f	4.15 ^g	4.15
T14	5.40 ^d	5.25 ^d	4.96 ^d	4.61 ^d	4.61
T15	5.61 ^c	5.37 ^c	5.05 ^c	4.78 ^c	4.78
T16	5.31 ^e	5.09 ^e	4.79 ^e	4.41 ^e	4.41
T17	5.26 ^f	5.08 ^e	4.77 ^e	4.36 ^f	4.36
T18	5.90 ^b	5.78 ^b	5.40 ^b	5.23 ^b	5.23
T19	5.94 ^a	5.88 ^a	5.63 ^a	5.40 ^a	5.4
T20	5.13 ^g	4.99 ^f	4.67 ^g	4.02 ^h	4.02
Mean (%)	5.52	5.35	5.05	4.71	

Appendix IV

a. Effect of MAP and bee wax coating on lightness 'L' of passion fruit

Treatments	Storage period (weeks)				Mean
	1	2	3	4	
T0	59.76 ^d	60.53 ^g	65.57 ^f	73.08 ^d	64.74
T1	56.33 ^{bc}	56.92 ^d	57.34 ^c	66.98 ^c	59.40
T2	53.16 ^a	53.99 ^b	53.69 ^{ab}	55.54 ^a	54.10
T3	57.72 ^c	58.81 ^f	62.68 ^e	72.06 ^d	62.82
T4	57.01 ^c	57.86 ^e	58.85 ^d	68.02 ^c	60.44
T5	55.20 ^b	55.35 ^c	54.66 ^b	58.10 ^b	55.83
T6	52.83 ^a	53.11 ^a	53.46 ^a	54.52 ^a	53.48
T20	66.14 ^e	70.78 ^h	74.31 ^g	79.26 ^e	72.63
Mean	56.00	56.65	58.04	64.05	

b. Effect of MAP and bee wax coating on yellowness 'b' of passion fruit

Treatments	Storage period (weeks)				Mean
	1	2	3	4	
T0	35.26 ^f	41.61 ^{ef}	45.49 ^{fg}	46.99 ^f	42.34
T1	28.22 ^c	30.00 ^c	33.81 ^c	35.41 ^d	31.86
T2	26.37 ^b	28.52 ^{bc}	31.63 ^b	34.11 ^c	30.16
T3	33.04 ^e	39.69 ^e	43.94 ^e	46.84 ^f	40.88
T4	30.56 ^d	35.91 ^d	38.98 ^d	40.33 ^c	36.45
T5	26.12 ^b	27.39 ^b	30.01 ^{ab}	32.23 ^b	28.94
T6	25.07 ^a	26.42 ^a	28.34 ^a	29.68 ^a	27.38
T20	39.49 ^g	43.94 ^g	46.72 ^g	47.94 ^g	44.53
Mean	29.24	32.79	36.03	37.94	

c. Effect of MAP on greenness 'a' of uncoated fruits

Treatments	Storage period (weeks)				Mean
	1	2	3	4	
T7	-7.21 ^d	-5.82 ^b	-4.12 ^d	-2.36 ^{bc}	-4.88
T8	-8.55 ^c	-6.38 ^b	-5.38 ^{bc}	-3.21 ^{abc}	-5.88
T9	-8.94 ^c	-6.61 ^{ab}	-6.43 ^{ab}	-4.66 ^{abc}	-6.66
T10	-9.78 ^b	-7.16 ^{ab}	-6.44 ^{ab}	-5.39 ^{ab}	-7.19
T11	-7.47 ^d	-5.94 ^b	-4.82 ^{cd}	-2.92 ^{abc}	-5.29
T12	-10.41 ^a	-8.22 ^a	-7.37 ^a	-6.13 ^a	-8.03
T20	-6.39 ^e	-4.14 ^c	-2.570 ^c	-1.39 ^c	-3.62
Mean	-8.73	-6.69	-5.76	-4.11	

d. Effect of MAP and commercial wax coating on lightness 'L' of passion fruit

Treatments	Storage period (weeks)				Mean
	1	2	3	4	
T13	65.72 ^{bc}	69.60 ^c	73.13 ^{dc}	77.71 ^t	71.54
T14	63.11 ^{abc}	67.07 ^{ab}	71.23 ^{bc}	73.85 ^d	68.82
T15	64.53 ^{ab}	66.23 ^a	68.27 ^a	70.20 ^{bc}	67.31
T16	63.18 ^{bc}	68.97 ^{bc}	72.28 ^{cd}	75.78 ^e	70.05
T17	65.24 ^{ab}	66.69 ^a	70.14 ^b	70.88 ^c	68.24
T18	63.52 ^{ab}	65.53 ^a	67.57 ^a	69.89 ^b	66.63
T19	62.46 ^a	65.17 ^a	66.97 ^a	68.05 ^a	65.66
T20	66.14 ^c	70.79 ^c	74.31 ^e	79.27 ^e	72.63
Mean	63.97	67.04	69.94	72.34	

e. Effect of MAP and commercial wax coating on yellowness 'b' of passion fruit

Treatments	Storage period (weeks)				Mean
	1	2	3	4	
T13	38.21 ^c	41.77 ^c	44.86 ^{dc}	46.17 ^{de}	42.75
T14	38.20 ^{cd}	40.16 ^{bc}	42.71 ^{cd}	44.69 ^{cd}	41.44
T15	36.86 ^{bc}	39.67 ^{bc}	40.97 ^{bc}	41.74 ^b	39.81
T16	38.18 ^{cd}	39.98 ^{bc}	41.04 ^{bc}	42.76 ^{bc}	40.49
T17	37.87 ^{cd}	40.42 ^{bc}	41.17 ^{bc}	42.98 ^{bc}	40.61
T18	35.91 ^{ab}	39.14 ^a	40.09 ^{ab}	41.01 ^{ab}	39.03
T19	34.49 ^a	36.43 ^a	38.16 ^a	39.27 ^a	37.09
T20	39.49 ^d	43.94 ^d	46.72 ^e	47.95 ^e	44.53
Mean	37.10	39.65	41.28	42.66	

Appendix V

a. Variation in pulp m.c of uncoated fruits

Treatments	Storage period (weeks)				Mean (%)
	1	2	3	4	
T7	71.79 ^f	71.39 ^f	64.79 ^f	61.64 ^f	67.40
T8	73.61 ^e	72.29 ^e	68.35 ^e	63.01 ^e	69.31
T9	73.79 ^d	72.38 ^d	68.81 ^d	64.38 ^d	69.84
T10	75.07 ^b	73.65 ^b	70.39 ^b	66.47 ^b	71.40
T11	74.39 ^c	73.48 ^c	69.60 ^c	65.38 ^c	70.71
T12	76.79 ^a	74.08 ^a	72.80 ^a	70.79 ^a	73.61
T20	65.99 ^g	66.60 ^g	62.99 ^g	60.81 ^g	64.10
Mean (%)	74.24	72.88	69.12	65.28	

b. Variation in peel m.c of uncoated fruits

Treatments	Storage period (weeks)				Mean (%)
	1	2	3	4	
T7	80.51 ^f	80.62 ^f	79.88 ^f	76.52 ^f	79.38
T8	84.20 ^b	87.51 ^b	84.09 ^b	78.91 ^b	83.67
T9	81.65 ^e	84.58 ^e	80.17 ^e	77.20 ^e	80.90
T10	83.29 ^c	85.36 ^d	80.89 ^d	77.45 ^d	81.74
T11	83.14 ^d	86.90 ^c	83.54 ^c	77.82 ^c	82.85
T12	84.70 ^a	88.75 ^a	84.16 ^a	80.43 ^a	84.51
T20	80.12 ^g	79.76 ^g	78.74 ^g	72.46 ^g	77.77
Mean (%)	82.91	85.62	82.12	78.05	

Appendix VI

Change in ascorbic acid of uncoated fruits during storage period

Treatments	Storage period (weeks)				Mean
	1	2	3	4	
T7	38.15 ^b	37.50 ^a	29.99 ^b	24.65 ^d	32.57
T8	38.58 ^d	37.49 ^a	29.99 ^b	24.65 ^d	32.67
T9	38.80 ^e	37.50 ^a	29.99 ^b	23.40 ^b	32.42
T10	38.35 ^c	37.50 ^a	29.99 ^b	23.40 ^b	32.31
T11	38.37 ^c	37.49 ^a	27.99 ^a	23.65 ^c	31.87
T12	37.80 ^a	37.52 ^a	28.00 ^a	21.91 ^a	31.30
T20	42.57 ^f	40.51 ^b	32.00 ^c	24.91 ^e	34.99
Mean	38.34	37.50	29.33	23.61	

Appendix VII

a. Change in firmness of bee wax coated fruits

Treatments	Storage period (weeks)				Mean
	1	2	3	4	
T0	61.66 ^t	57.00 ^g	51.52 ^g	47.73 ^g	54.47
T1	65.00 ^d	62.80 ^d	57.60 ^d	55.24 ^d	60.16
T2	66.99 ^c	63.49 ^c	58.69 ^c	56.02 ^c	61.30
T3	62.52 ^e	57.52 ^t	52.61 ^t	48.95 ^t	55.40
T4	63.00 ^e	59.00 ^e	53.27 ^e	49.69 ^e	56.24
T5	72.14 ^b	67.14 ^b	60.44 ^b	58.22 ^b	64.48
T6	73.95 ^a	69.95 ^a	64.75 ^a	60.84 ^a	67.37
T20	50.81 ^g	47.61 ^h	41.21 ^h	31.51 ^h	42.78
Mean	64.51	60.56	55.00	51.02	

b. Change in firmness of commercial wax coated fruits

Treatments	Storage period (weeks)				Mean
	1	2	3	4	
T13	67.82 ^g	60.32 ^g	52.91 ^g	46.11 ^g	56.79
T14	82.39 ^c	75.20 ^c	70.90 ^c	64.30 ^c	73.20
T15	69.74 ^t	61.44 ^t	53.93 ^t	46.34 ^t	57.86
T16	79.60 ^d	72.89 ^d	61.19 ^d	60.09 ^d	68.44
T17	83.59 ^b	79.59 ^b	73.19 ^b	67.64 ^b	76.00
T18	76.65 ^e	67.26 ^e	57.98 ^e	50.88 ^e	63.19
T19	88.72 ^a	80.03 ^a	75.52 ^a	69.32 ^a	78.40
T20	50.81 ^h	47.61 ^h	41.21 ^h	31.51 ^h	42.78
Mean	78.36	70.96	63.66	57.81	

**DEVELOPMENT AND EVALUATION OF MODIFIED
ATMOSPHERE PACKED PASSION FRUIT
(*Passiflora edulis*)**

By

**R. MADHANA SUPRIYA
(2010-18-110)**

Abstract

Submitted in partial fulfilment
of the requirement for the award of degree of

**Master of Technology
In
Agricultural Engineering**



**Faculty of Agricultural Engineering and Technology
Kerala Agricultural University**

**Department of Post Harvest Technology and Agricultural Processing
KELAPPAJI COLLEGE OF AGRICULTURAL ENGINEERING AND TECHNOLOGY
TAVANUR – 679 573, MALAPPURAM DISTRICT
KERALA**

2012

ABSTRACT

Passion fruit is a tropical fruit which is extensively used in juice processing. The fruit is highly perishable and loses its quality immediately after the second day of harvest. The postharvest loss in quality and commercial value is due to the intense respiratory activity and significant moisture loss. Hence a study was undertaken to develop a wax applicator to extend the shelf life of passion fruit by adopting the postharvest technologies. A simple and efficient wax applicator with a capacity of 250 kg.hr⁻¹ was developed based on the physical properties of the fruits. Various samples of the passion fruits were treated with bee wax and commercial wax packed in LDPE bags of 200 and 400 gauge. The effect on the shelf life extension of fruits was investigated individually and in combination of wax and LDPE bags. In the case of LDPE bags, different levels of perforations such as 0%, 0.5%, 1% and 2% were used. The samples were kept in ambient condition viz., 32 - 35°C and 70 - 80% RH and at cold conditions as 7°C and 90% RH.

The physicochemical characteristics of samples were tested periodically at an interval of 5 and 7 days, under ambient and cold storage conditions, respectively. The results obtained were subjected to statistical analysis. From the results it was revealed that the samples kept in non-perforated polythene covers were found to be better than those kept in perforated bags and in normal atmosphere. A maximum shelf life of 40 days was obtained for passion fruits at 7°C coated with commercial wax emulsion. Thus, commercial wax coating in combination with LDPE bags acted as a barrier against moisture loss and respiration rate of fruits. However, the fruits kept as control had lost consumer acceptability after the tenth day of study at cold condition and within two days at ambient storage conditions.